



mirolxtec
water treatment



Ductile Iron Pipe

Generaal Lemanstraat 55/2 2019 Antwerpen Belgium

0032474050255

info@mirolxtec.com

www.mirolxtec.com





HIGH-QUALITY INDUSTRIAL PUMPS MANUFACTURER

MIROLX BV is a professional manufacturer of high quality industrial pumps, with the business purpose of "Quality As The Basis, Sales For Development" and the value of "Technology First, Beyond Self". We use super high casting technology, high quality parts to create the best quality products. In order to better meet customer demand and business expansion needs, We are looking for agents and cooperative partner from all over the world. Our quality and production of products improved year by year, YOKING has entered a period of rapid development, but we will work harder, constantly improve the product framework, innovative technology, will be more excellent products and perfect service for the majority of customers.



0032474050255
www.mirolxtec.com info@mirolxtec.com
Generaal Lemanstraat 55/2 2019 Antwerpen Belgium



01

TD

Single-Stage Pipeline Circulation Pump



56

YSG/YSW

High Quality Dry Grinding Resistant Pipeline Pump



146

XA/XAT

Standardized End Suction Centrifugal Pump



237

PUN

Centrifugal Booster Pump



14

CDL(F)

Light-duty Stainless Steel Vertical Multistage Centrifugal Pump



71

LT/WLT

Closed Cooling Tower Special Pump



197

HSF

Stainless Steel Sea Water Pump



240

PH

Small Pipe Pump



27

DGWQ

Double-Knife High Head Cutting Submersible Sewage Pumps



76

IRG/ISW/IRGB ISWB/IHG/IHW

Single Stage Single Suction Pipeline Centrifugal Pump



199

CA(B)/CAG(B)

Stainless Steel Centrifugal Pump



243

ZW

Direct Coupling Type Self-priming Centrifugal Sewage Pump



29

WQ(D)/JYWQ

Submersible Sewage Pump



111

YST

Standard Centrifugal Pump



219

MS

Horizontal single-stage Centrifugal Pump



249

BZ

Self-priming Centrifugal Pump for Clean Water



43

WQK

Cutting Submersible Sewage Pump



125

YS/YSM/YSO

End Suction Centrifugal Pump



223

CMI

Stainless Steel Horizontal Multistage Centrifugal Pump



252

YEDJ

Fire Fighting System



49

QY

Oil Immersed Submersible Electric Pump



133

YSC

Split-Case Pump



233

MHI

Horizontal Multistage Stainless Steel Pump



TD

Single-Stage Pipeline Circulation Pump



Private House



Civil use



Industrial use



Product Overview

TD Series Single-Stage Pipeline Circulation Pump, equipped with standard motor and mechanical seal, the structure of TD is less likely to be affected by impurities in the pump liquid than similar products. This series is designed in a pull-out top disassembly form, which allows the pump to be repaired without affecting the piping system. TD32-TD150 caliber products are of extended shaft structure, and TD200-TD300 caliber products are of disassembled structure, and the disassembled structure adopts integrated mechanical seal, so there is no need to disassemble the motor when replacing the mechanical seal.

Application

TD pump is a multi-purpose product, which can convey different media from tap water to industrial liquid, mainly used as liquid conveying, pressurizing and circulating equipment. For example: district heating system (the water quality in the heating system should meet the recognized water quality standard of the system) HVAC system, cooling system, domestic hot water system, industrial liquid conveying, water supply system.

Motor

- Motor is a fully enclosed, air-cooled two or four pole
- standard motor.
- Protection Class : IP55
- Insulation Class: F
- Voltage : 50Hz: 1 × 220-230/240V
3 × 200-220/346-380V
3 × 220-240/380-415V

Operating Conditions

- TD pump is suitable for conveying thin, clean, non-erosive, non-flammable and non-explosive, and does not contain solid particles, fibers or liquids with physical and chemical properties similar to water. In the case of viscous or dense liquids, the pump characteristic curve will be reduced and energy consumption will be increased.
- Max. working pressure: 12 bar for conventional models, 16 bar for special models
- Liquid Temperature: -15°C to 110°C
- Ambient Temperature: up to +40°C
- Altitude: up to 1000m
- Rotation Direction: Clockwise (looking down from motor blade end)

Model Implication

TD 50 - 24 G / 2

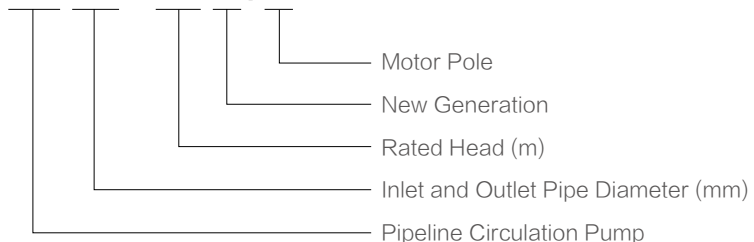

Minimum Inlet Pressure – NPSH

To avoid cavitation, it is necessary to ensure a minimum pressure on the inlet side of the pump. The maximum suction height "H" can be calculated as follows:

$$H = P_b \times 10.2 - NPSH - H_f - H_v - H_s$$

- **H** is maximum suction head (m)
- **P_b** is atmospheric pressure in bar
(Can be set to 1bar, in closed system, P_b is system pressure)
- **NPSH** is the net positive suction head of the pump in m; the corresponding value at maximum flow can be read in the graph
- **H_f** is the suction line resistance loss in m (at the maximum flow of the pump)
- **H_v** is the vaporization pressure in m
(can be read from the vaporization pressure gauge. Its value depends on the liquid temperature "tm")
- **H_s** is the minimum safety margin of 0.5m
- If the calculated "H" is positive, the pump can operate at a maximum suction height of "H"
- If the calculated "H" is negative, the pump requires a minimum "H" inlet pressure

It is recommended to calculate the inlet pressure "H" when the following conditions exist:

- High liquid temperature
- The flow is significantly greater than the rated flow
- Pump water from low
- Pumping water from long pipes
- Poor import conditions

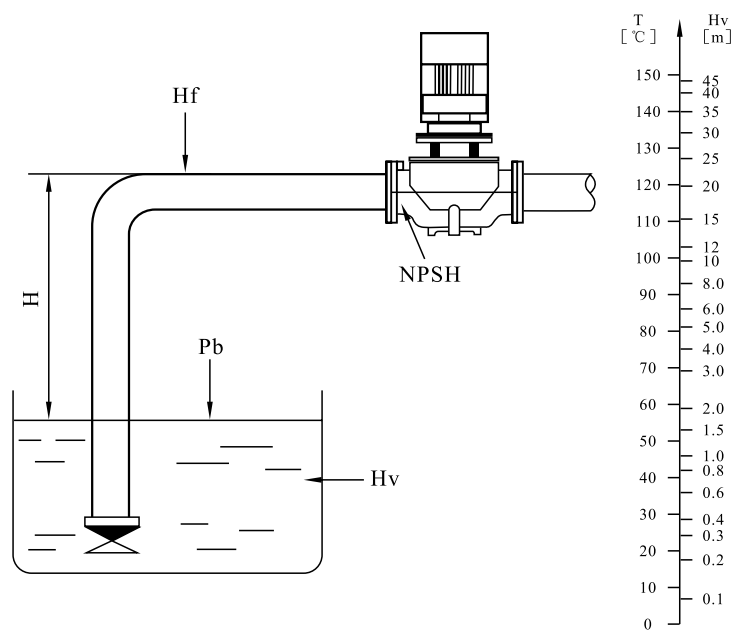

NOTE: To avoid cavitation, the pump should be rated away from the right side of the NPSH curve. Always check the NPSH value of the pump at the highest possible flow.

Scope of Performance

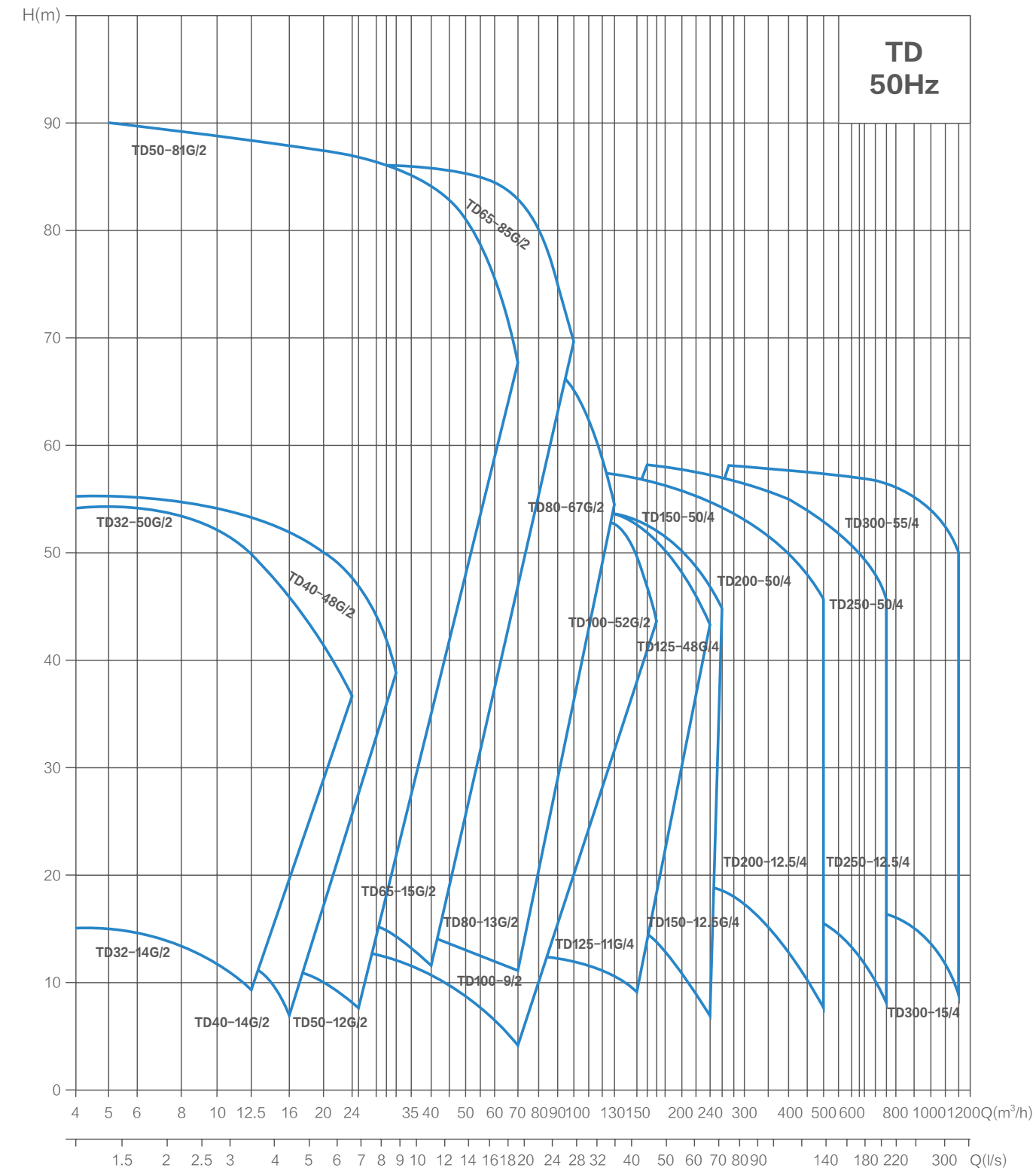

Hydraulic Performance Curves

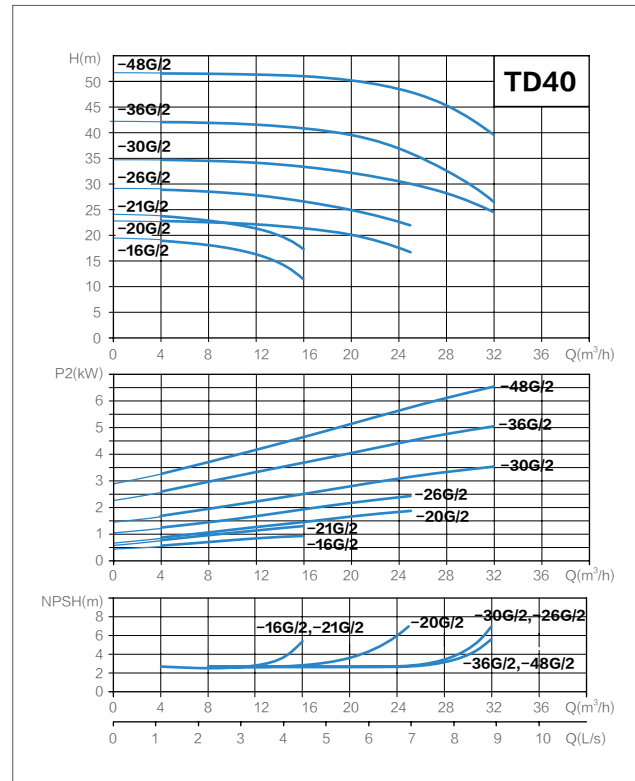
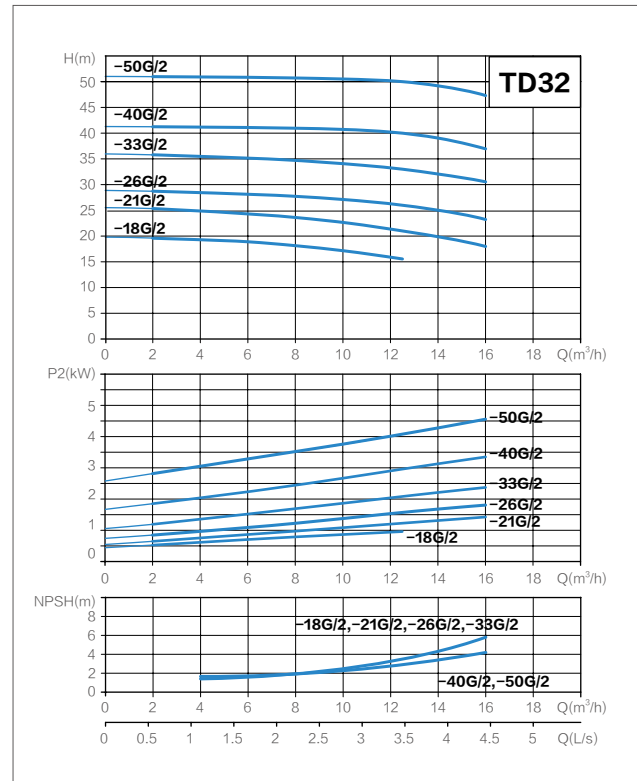

Hydraulic Performance Curves

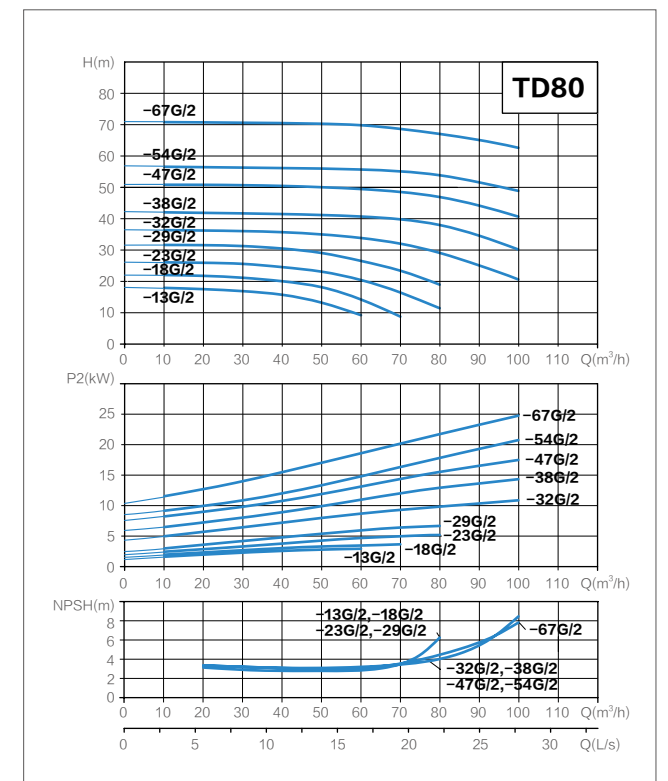
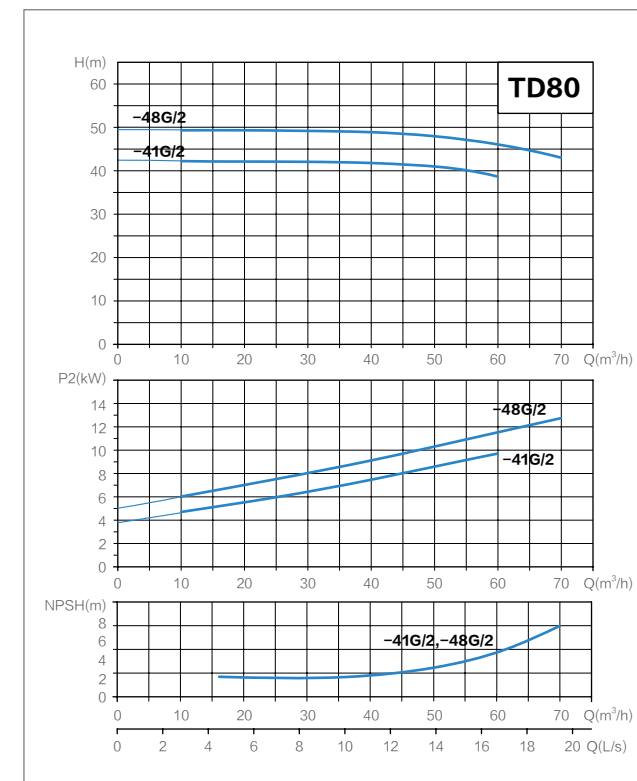
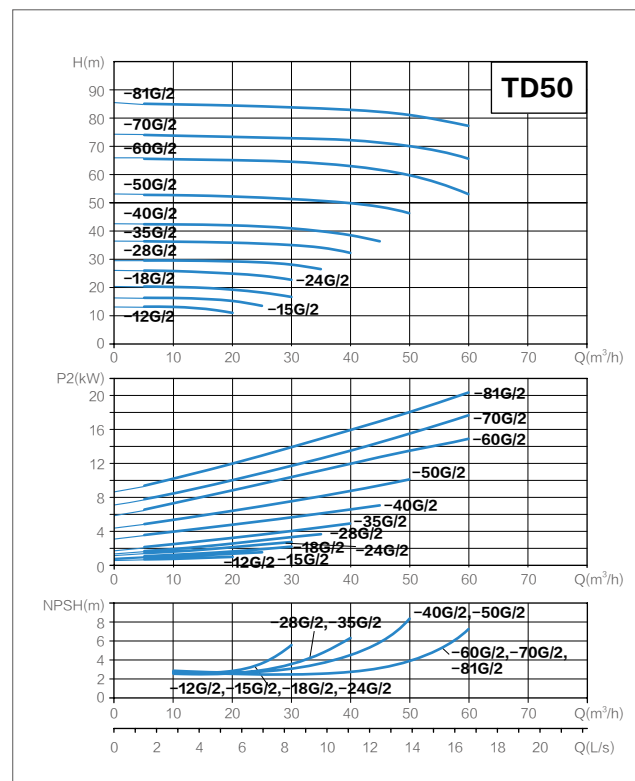
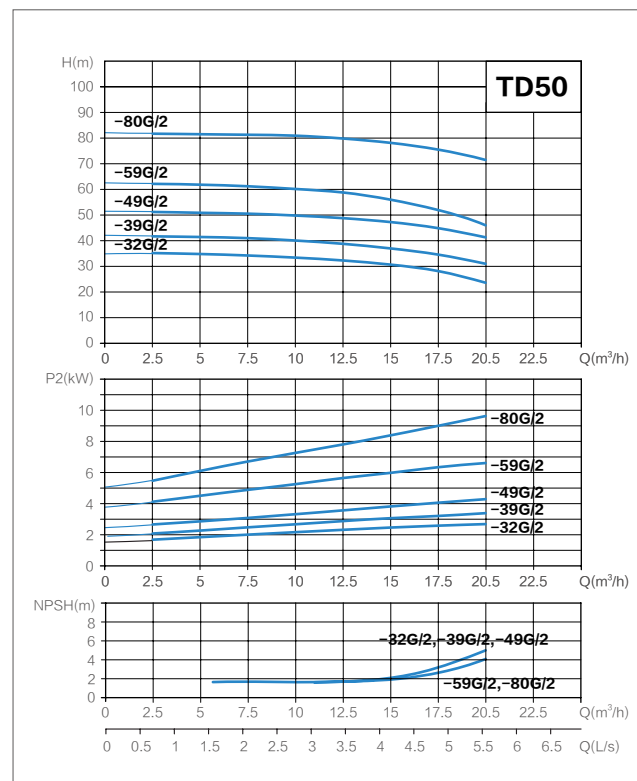
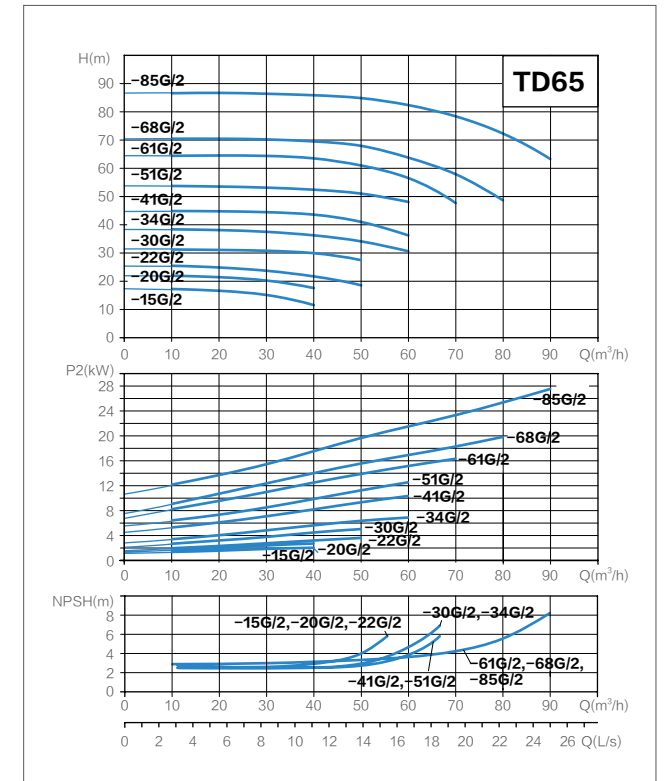
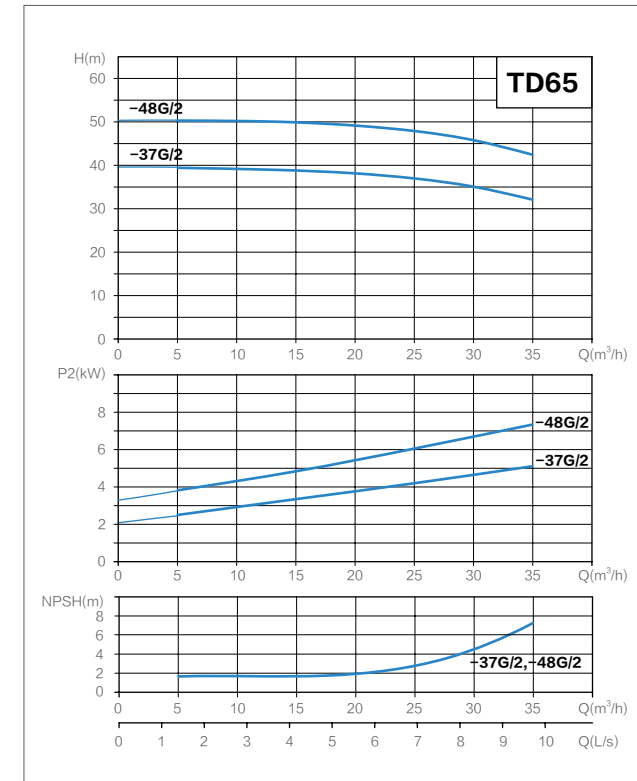

Hydraulic Performance Curves

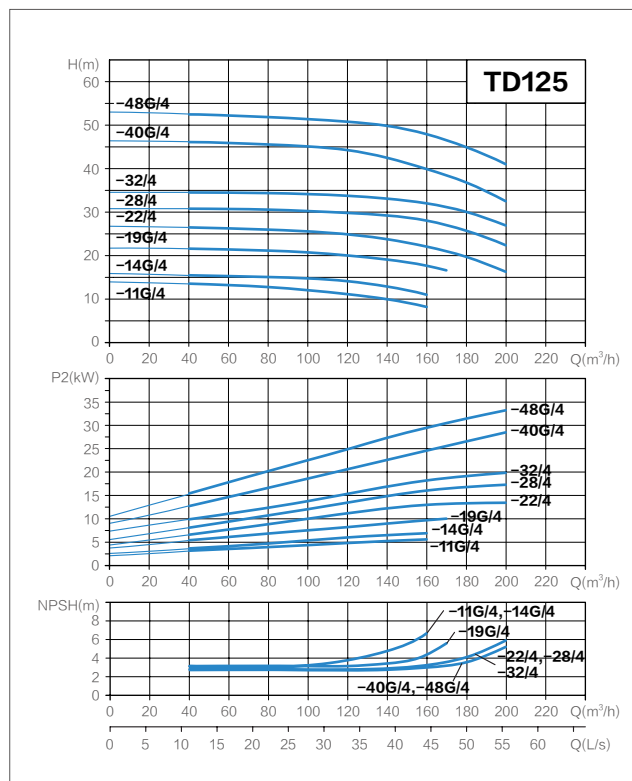
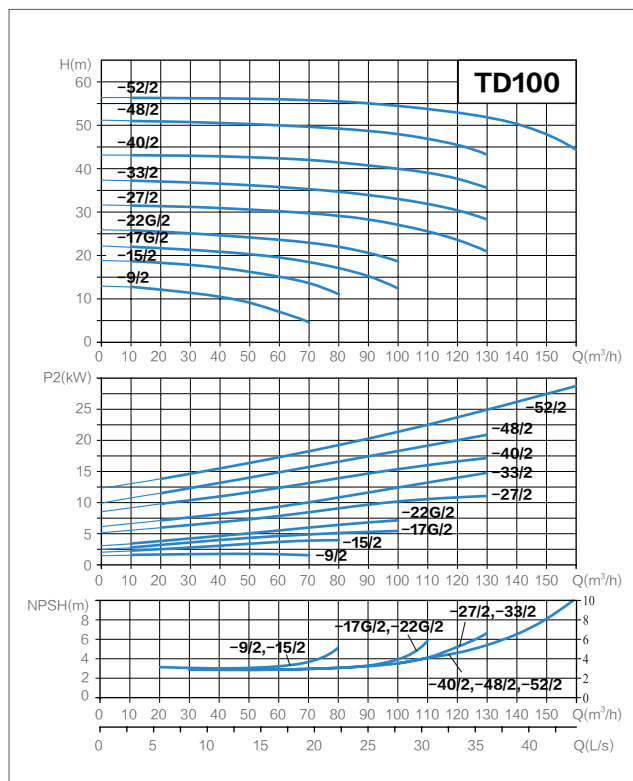

Hydraulic Performance Curves

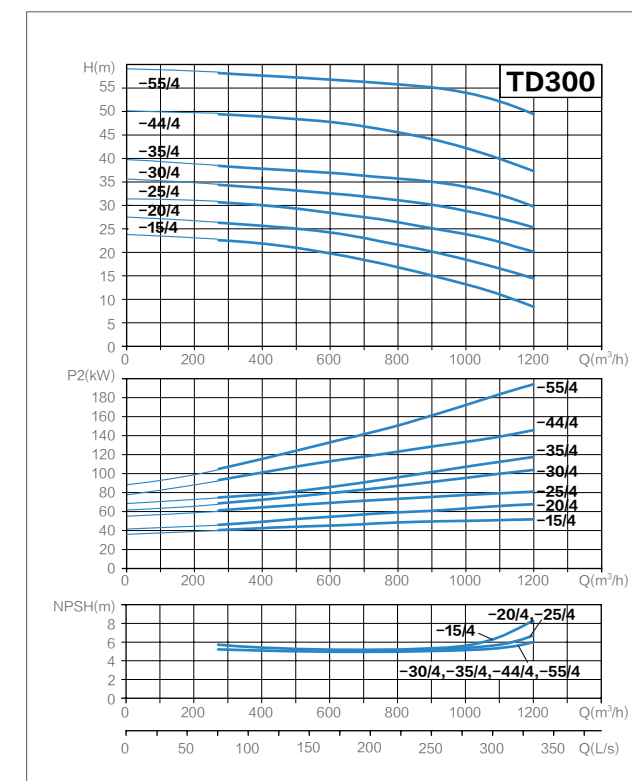
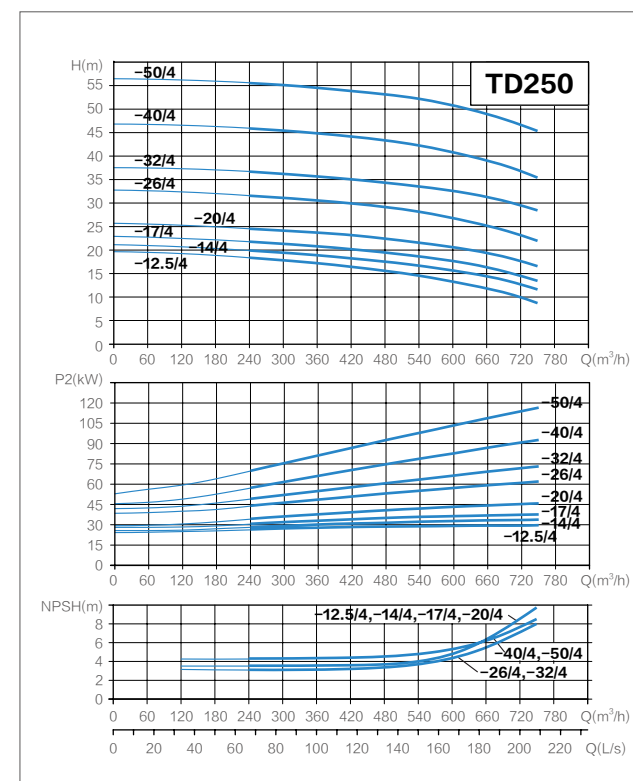
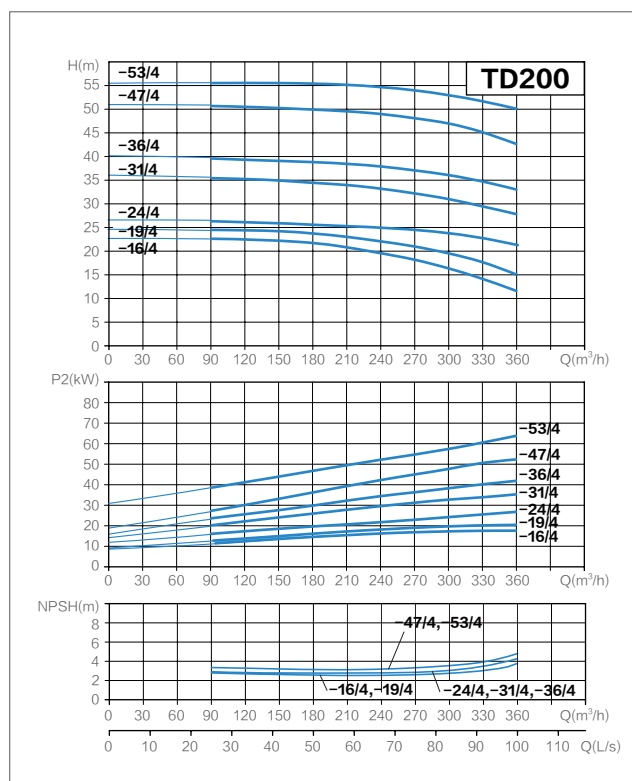
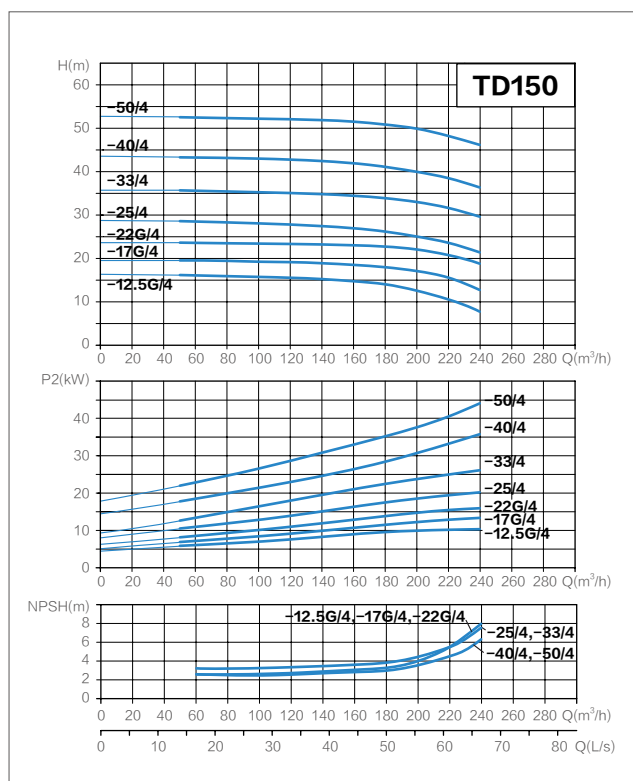
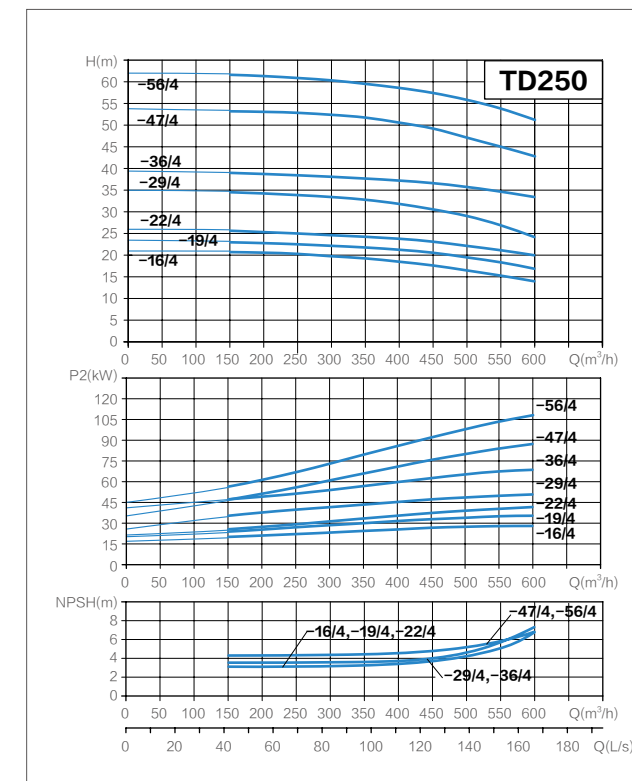
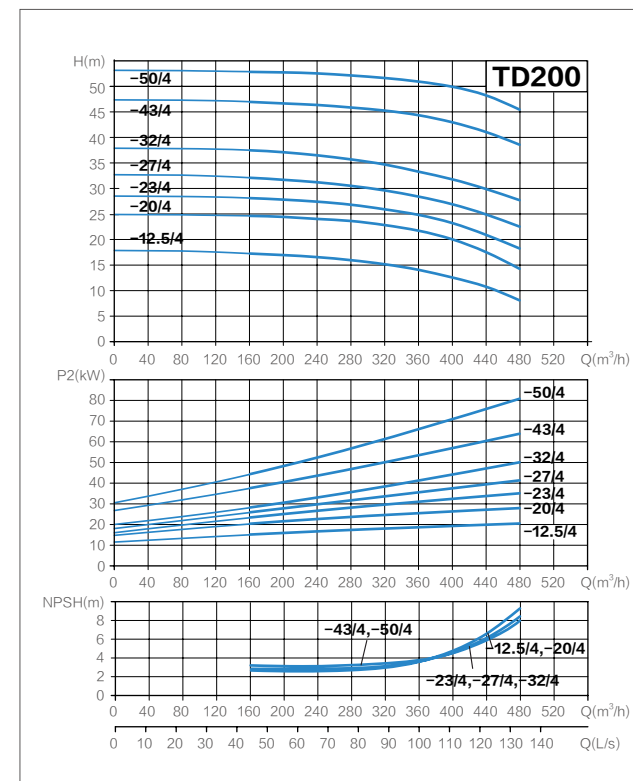

Technical Parameter

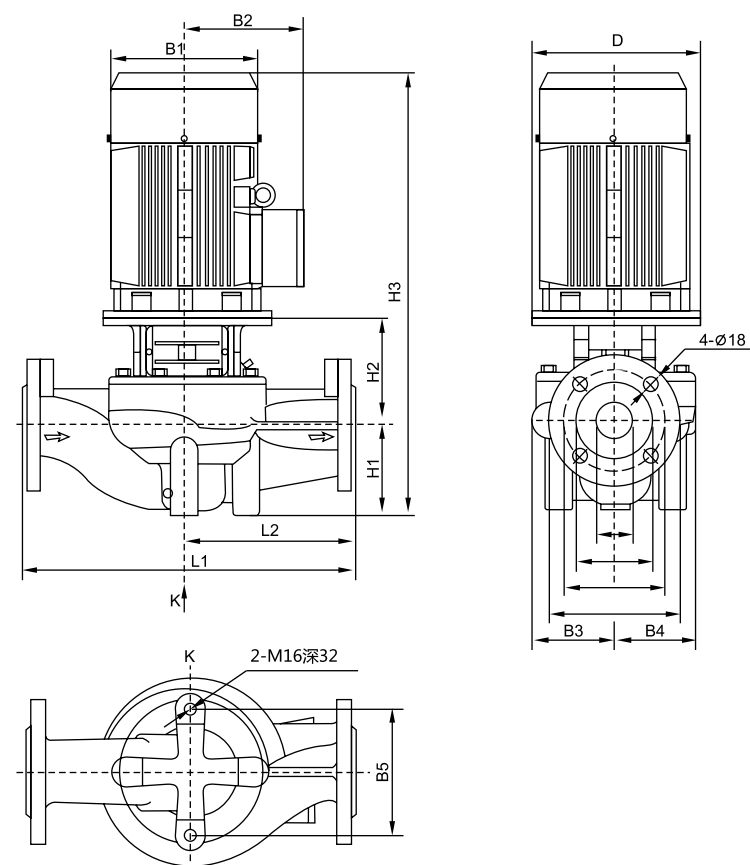

NO.	Model	Q (m³/h)	H (m)	N (r/min)	Standard motor voltage (V)		Size(mm)										Weight (kg)	
					1×220V P2(kW)	3×380V P2(kW)	D	B1	B2	B3	B4	B5	H1	H2	H3	L1		L2
1	TD32-14G/2	8	14	2900	0.75	0.75	120	151	125	101	101	144	90	135	469	320	160	33
2	TD32-18G/2	8	18		1.1	1.1	120	151	125	101	101	144	90	135	469	320	160	34
3	TD32-21G/2	12.5	21		1.5	1.5	140	171	137	101	101	144	90	137	514	320	160	38
4	TD32-26G/2	12.5	26		2.2	2.2	140	171	137	101	101	144	90	137	514	320	160	42
5	TD32-33G/2	12.5	33		3	3	160	196	150	109	109	144	90	145	572	340	170	52
6	TD32-40G/2	12.5	40		4	4	160	214	169	128	128	144	100	151	593	360	180	65
7	TD32-50G/2	12.5	50		5.5	5.5	200	257	190	128	128	144	100	173	656	360	180	84
8	TD40-14G/2	8	14		0.75	0.75	122	151	125	98	95	120	68	139	451	320	160	31
9	TD40-16G/2	12.5	16		1	1.1	122	151	125	98	95	120	68	139	451	320	160	32

Technical Parameter

NO.	Model	Q (m³/h)	H (m)	N (r/min)	Standard motor voltage (V)		Size(mm)										Weight (kg)	
					1×220V P2(kW)	3×380V P2(kW)	D	B1	B2	B3	B4	B5	H1	H2	H3	L1		L2
10	TD40-21G/2	12.5	21	2900	1.5	1.5	140	171	137	98	95	120	68	149	504	320	160	38
11	TD40-20G/2	20	20		2.2	2.2	140	171	137	105	95	144	85	144	516	320	160	43
12	TD40-26G/2	20	26		3	3	160	196	150	116	109	144	85	156	578	340	170	54
13	TD40-30G/2	25	30		4	4	160	214	169	116	109	144	85	156	583	340	170	62
14	TD40-36G/2	25	36		5.5	5.5	200	257	190	133	128	144	90	181	654	380	190	85
15	TD40-48G/2	25	48		7.5	7.5	200	257	190	133	128	144	90	181	654	380	190	94
16	TD50-32G/2	12.5	32		3	3	160	196	150	128	128	144	105	150	592	400	200	64
17	TD50-39G/2	12.5	39		4	4	160	214	169	128	128	144	105	150	597	400	200	71
18	TD50-49G/2	12.5	49		5.5	5.5	200	257	190	128	128	144	105	172	660	400	200	88
19	TD50-59G/2	12.5	59		7.5	7.5	200	257	190	163	163	144	105	178	666	440	220	112
20	TD50-80G/2	12.5	80		11	11	350	314	261	163	163	144	105	222	783	440	220	184
21	TD50-12G/2	16	12		1.1	1.1	120	151	125	114	101	144	105	135	484	340	170	37
22	TD50-15G/2	20	15		1.5	1.5	140	171	137	114	101	144	105	137	529	340	170	42
23	TD50-18G/2	25	18		2.2	2.2	140	171	137	114	101	144	105	137	529	340	170	45
24	TD50-24G/2	25	24		3	3	160	196	150	114	101	144	105	147	589	340	170	55
25	TD50-28G/2	30	28		4	4	160	214	169	118	109	144	105	152	599	340	170	64
26	TD50-35G/2	30	35		5.5	5.5	200	257	190	118	109	144	105	175	663	340	170	81
27	TD50-40G/2	35	40		7.5	7.5	200	257	190	142	138	144	105	175	663	400	200	98
28	TD50-50G/2	40	50		11	11	350	314	261	142	138	144	105	225	830	400	200	173
29	TD50-60G/2	50	60		15	15	350	314	261	171	163	144	115	225	840	440	220	196
30	TD50-70G/2	50	70		18.5	18.5	350	314	261	171	163	144	115	225	884	440	220	203
31	TD50-81G/2	50	81		22	22	350	355	273	171	163	144	115	225	917	440	220	256
32	TD65-37G/2	25	37		5.5	5.5	200	257	190	128	128	144	105	180	668	400	200	90
33	TD65-48G/2	25	48		7.5	7.5	200	257	190	128	128	144	105	180	668	400	200	98
34	TD65-15G/2	30	15		2.2	2.2	140	171	137	116	101	144	105	153	545	340	170	48
35	TD65-20G/2	30	20		3	3	160	196	150	116	101	144	105	163	605	340	170	57
36	TD65-22G/2	40	22		4	4	160	214	169	116	101	144	105	163	610	340	170	64
37	TD65-30G/2	40	30		5.5	5.5	200	257	190	131	115	144	105	194	682	360	180	85
38	TD65-34G/2	50	34		7.5	7.5	200	257	190	131	115	144	105	194	682	360	180	94
39	TD65-41G/2	50	41		11	11	350	314	261	148	138	144	105	234	839	400	200	173
40	TD65-51G/2	50	51	15	15	350	314	261	148	138	144	105	234	839	400	200	188	
41	TD65-61G/2	50	61	18.5	18.5	350	314	261	174	162	160	125	228	897	475	238	208	
42	TD65-68G/2	50	68	22	22	350	355	273	174	162	160	125	228	930	475	238	260	
43	TD65-85G/2	50	85	30	30	400	397	314	174	162	160	125	231	1008	475	238	322	
44	TD80-41G/2	50	41	11	11	350	314	261	137	128	144	115	221	836	500	250	176	

Technical Parameter

NO.	Model	Q (m³/h)	H (m)	N (r/min)	Standard motor voltage (V)		Size(mm)										Weight (kg)	
					1×220V P2(kW)	3×380V P2(kW)	D	B1	B2	B3	B4	B5	H1	H2	H3	L1		L2
45	TD80-48G/2	50	48	2900		15	350	314	261	137	128	144	115	221	836	500	250	191
46	TD80-13G/2	50	13		2.2	3	160	196	150	134	112	144	105	171	613	400	200	63
47	TD80-18G/2	50	18		4	160	214	169	134	112	144	105	171	618	400	200	70	
48	TD80-23G/2	50	23		5.5	200	257	190	134	112	144	105	195	683	400	200	87	
49	TD80-29G/2	50	29		7.5	200	257	190	134	112	144	105	195	683	400	200	95	
50	TD80-32G/2	70	32		11	350	314	261	159	138	144	115	240	855	450	225	179	
51	TD80-38G/2	80	38		15	350	314	261	159	138	144	115	240	855	450	225	194	
52	TD80-47G/2	80	47		18.5	350	314	261	159	138	144	115	240	899	450	225	203	
53	TD80-54G/2	80	54		22	350	355	273	159	138	144	115	240	932	450	225	256	
54	TD80-67G/2	80	67		30	400	397	314	180	162	160	115	242	1017	500	250	324	
55	TD100-9/2	50	9		2.2	140	171	137	134	101	160	105	178	570	450	225	56	
56	TD100-15/2	60	15		4	160	214	169	134	101	160	105	190	637	450	225	73	
57	TD100-17G/2	80	17		5.5	200	257	190	146	118	144	120	199	702	450	225	96	
58	TD100-22G/2	80	22		7.5	200	257	190	146	118	144	120	199	702	450	225	104	
59	TD100-27/2	100	27	11	350	314	261	147	123	144	140	260	900	550	275	187		
60	TD100-33/2	100	33	15	350	314	261	147	123	144	140	260	900	550	275	202		
61	TD100-40G/2	100	40	18.5	350	314	261	181	152	230	140	270	954	550	275	220		
62	TD100-48G/2	100	48	22	350	355	273	181	152	230	140	270	987	550	275	273		
63	TD100-52G/2	130	52	30	400	397	314	181	152	230	140	270	1062	550	275	336		
64	TD125-11G/4	120	11	5.5	200	257	190	198	162	230	160	229	772	620	310	140		
65	TD125-14G/4	120	14	7.5	200	257	190	198	162	230	160	229	772	620	310	150		
66	TD125-19G/4	140	19	11	350	314	261	213	178	230	160	301	961	660	330	255		
67	TD125-22G/4	160	22	15	350	314	261	236	208	230	215	292	1051	800	400	310		
68	TD125-28G/4	160	28	18.5	350	355	273	236	208	230	215	292	1084	800	400	340		
69	TD125-32G/4	160	32	22	350	355	273	236	208	230	215	292	1122	800	400	361		
70	TD125-40G/4	160	40	30	400	397	314	261	233	230	160	298	1110	800	400	455		
71	TD125-48G/4	160	48	37	400	445	334	261	233	230	160	313	1167	800	400	492		
72	TD150-12.5G/4	200	12.5	11	350	314	261	217	180	230	175	297	972	660	330	260		
73	TD150-17G/4	200	17	15	350	314	261	217	180	230	175	297	1016	660	330	281		
74	TD150-22G/4	200	22	18.5	350	355	273	217	180	230	175	297	1049	660	330	312		
75	TD150-25/4	200	25	22	350	355	273	238	208	230	215	269	1061	800	400	365		
76	TD150-33/4	200	33	30	400	397	314	238	208	230	215	269	1136	800	400	445		
77	TD150-40/4	200	40	37	450	445	334	267	248	230	230	288	1212	900	450	518		
78	TD150-50/4	200	50	45	450	445	334	267	248	230	230	288	1212	900	450	570		
79	TD200-16/4	300	16	18.5	350	355	273	278	219	360	270	415	1265	1000	500	417		

Technical Parameter

NO.	Model	Q (m³/h)	H (m)	N (r/min)	Standard motor voltage (V)		Size(mm)										Weight (kg)	
					1×220V P2(kW)	3×380V P2(kW)	D	B1	B2	B3	B4	B5	H1	H2	H3	L1		L2
80	TD200-19/4	300	19	1450		22	350	355	273	278	219	360	270	415	1305	1000	500	434
81	TD200-24/4	300	24		30	400	397	314	303	252	360	270	415	1335	1100	550	537	
82	TD200-31/4	300	31		37	450	445	334	303	252	360	270	445	1395	1100	550	602	
83	TD200-36/4	300	36		45	450	445	334	303	252	360	270	445	1420	1100	550	648	
84	TD200-47/4	300	47		55	550	484	367	315	269	360	270	457	1517	1100	550	744	
85	TD200-53/4	300	53		75	550	547	407	315	269	360	270	457	1587	1100	550	877	
86	TD200-12.5/4	400	12.5		22	350	355	273	278	219	360	270	415	1300	1000	500	432	
87	TD200-20/4	400	20		30	400	397	314	278	219	360	270	415	1334	1000	500	492	
88	TD200-23/4	400	23		37	450	445	334	303	252	360	270	445	1389	1100	550	602	
89	TD200-27/4	400	27		45	450	445	334	303	252	360	270	445	1412	1100	550	638	
90	TD200-32/4	400	32		55	550	484	367	303	252	360	270	445	1488	1100	550	710	
91	TD200-43/4	400	43		75	550	547	407	315	269	360	270	457	1556	1100	550	883	
92	TD200-50/4	400	50		90	550	547	407	315	269	360	270	457	1607	1100	550	975	
93	TD250-16/4	500	16		30	400	397	314	316	243	390	300	465	1430	1100	550	550	
94	TD250-19/4	500	19	37	450	445	334	316	243	390	300	495	1475	1100	550	611		
95	TD250-22/4	500	22	45	450	445	334	316	243	390	300	495	1500	1100	550	647		
96	TD250-29/4	500	29	55	550	484	367	329	264	440	300	507	1597	1100	550	773		
97	TD250-36/4	500	36	75	550	547	407	329	264	440	300	507	1667	1100	550	909		
98	TD250-47/4	500	47	90	550	547	407	347	292	440	305	485	1700	1200	600	1030		
99	TD250-56/4	500	56	110	660	645	535	347	292	440	305	525	1860	1200	600	1389		
100	TD250-12.5/4	630	12.5	30	400	397	314	316	243	390	300	465	1414	1100	550	552		
101	TD250-14/4	630	14	37	450	445	334	316	243	390	300	495	1469	1100	550	613		
102	TD250-17/4	630	17	45	450	445	334	316	243	390	300	495	1492	1100	550	649		
103	TD250-20/4	630	20	55	550	484	367	316	243	390	300	495	1568	1100	550	722		
104	TD250-26/4	630	26	75	550	547	407	329	264	440	300	507	1636	1100	550	909		
105	TD250-32/4	630	32	90	550	547	407	329	264	440	300	507	1687	1100	550	999		
106	TD250-40/4	630	40	110	660	645	535	347	292	440	305	525	1840	1200	600	1389		
107	TD250-50/4	630	50	132	660	645	535	347	292	440	305	525	1990	1200	600	1473		
108	TD300-15/4	900	15	55	550	484	367	345	250	440	290	649	1720	1200	600	907		
109	TD300-20/4	900	20	75	550	547	407	345	250	440	290	649	1770	1200	600	1075		
110	TD300-25/4	900	25	90	550	547	407	380	280	480	290	659	1850	1200	600	1230		
111	TD300-30/4	900	30	110	660	645	535	380	280	480	290	699	2000	1200	600	1570		
112	TD300-35/4	900	35	132	660	645	535	380	280	480	290	699	2150	1200	600	1650		
113	TD300-44/4	900	44	160	660	645	535	380	295	480	290	702	2150	1200	600	1790		
114	TD300-55/4	900	55	200	660	645	535	380	295	480	290	702	2150	1200	600	1905		

Accessories-Base Plate Size

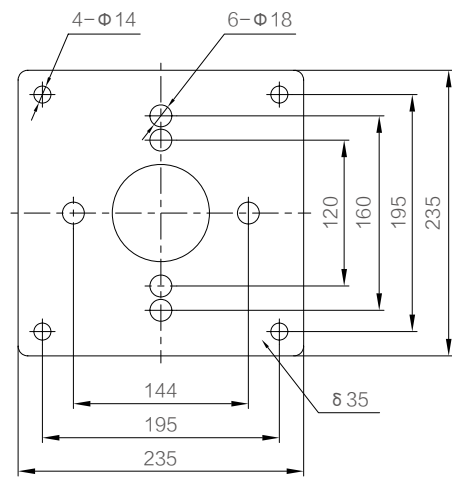

Base Plate A

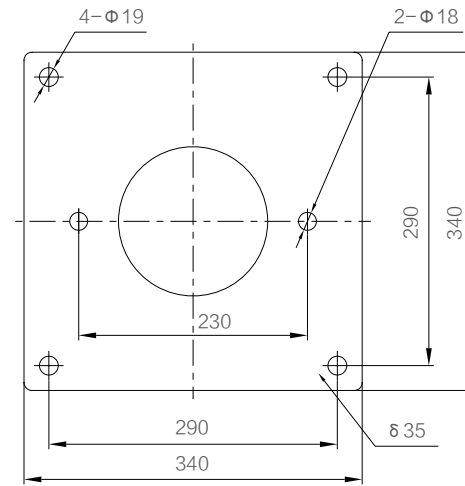

Base Plate B

NO.	Model	Base Plate Model	NO.	Model	Base Plate Model	NO.	Model	Base Plate Model
1	TD32-14G/2	A	27	TD50-40G/2	A	53	TD80-54G/2	A
2	TD32-18G/2	A	28	TD50-50G/2	A	54	TD80-67G/2	A
3	TD32-21G/2	A	29	TD50-60G/2	A	55	TD100-9/2	A
4	TD32-26G/2	A	30	TD50-70G/2	A	56	TD100-15/2	A
5	TD32-33G/2	A	31	TD50-81G/2	A	57	TD100-17G/2	A
6	TD32-40G/2	A	32	TD65-37G/2	A	58	TD100-22G/2	A
7	TD32-50G/2	A	33	TD65-48G/2	A	59	TD100-27/2	A
8	TD40-14G/2	A	34	TD65-15G/2	A	60	TD100-33/2	A
9	TD40-16G/2	A	35	TD65-20G/2	A	61	TD100-40G/2	B
10	TD40-21G/2	A	36	TD65-22G/2	A	62	TD100-48G/2	B
11	TD40-20G/2	A	37	TD65-30G/2	A	63	TD100-52G/2	B
12	TD40-26G/2	A	38	TD65-34G/2	A	64	TD125-11G/4	B
13	TD40-30G/2	A	39	TD65-41G/2	A	65	TD125-14G/4	B
14	TD40-36G/2	A	40	TD65-51G/2	A	66	TD125-19G/4	B
15	TD40-48G/2	A	41	TD65-61G/2	A	67	TD125-22G/4	B
16	TD50-32G/2	A	42	TD65-68G/2	A	68	TD125-28G/4	B
17	TD50-39G/2	A	43	TD65-85G/2	A	69	TD125-32G/4	B
18	TD50-49G/2	A	44	TD80-41G/2	A	70	TD125-40G/4	B
19	TD50-59G/2	A	45	TD80-48G/2	A	71	TD125-48G/4	B
20	TD50-80G/2	A	46	TD80-13G/2	A	72	TD150-12.5G/4	B
21	TD50-12G/2	A	47	TD80-18G/2	A	73	TD150-17G/4	B
22	TD50-15G/2	A	48	TD80-23G/2	A	74	TD150-22G/4	B
23	TD50-18G/2	A	49	TD80-29G/2	A	75	TD150-25/4	B
24	TD50-24G/2	A	50	TD80-32G/2	A	76	TD150-33/4	B
25	TD50-28G/2	A	51	TD80-38G/2	A	77	TD150-40/4	B
26	TD50-35G/2	A	52	TD80-47G/2	A	78	TD150-50/4	B

CDL(F)

Light-duty Stainless Steel Vertical Multistage Centrifugal Pump



Private House



Agricultural



Civil use



Industrial use



Main Application

CDL/CDLF is a multifunctional product that can transport various media from tap water to industrial liquids, and is suitable for different temperature, flow and pressure ranges. CDL is suitable for non-corrosive liquids, and CDL is suitable for mildly corrosive liquids.

Water Supply: water plant filtration and transmission, water plant zoning water delivery, main booster, highrise building booster.

Industrial Pressurization : Process water systems, cleaning systems, high-pressure flushing systems, fire-fighting systems.

Industrial fluid transfer : Cooling and air conditioning systems, boiler feed and condensing systems, machine tool sets, acids and alkalis.

Water treatment : Ultrafiltration systems, reverse osmosis systems, distillation systems, separators, swimming pools.

Irrigation: Agricultural irrigation, sprinkler irrigation, drip irrigation.

Operating Conditions

- Liquid Temperature:
- Normal Temperature Type -15°C to +70°C
- Hot Water Type - 15°C to +120°C
- Ambient Temperature: Max. +40°C
- Altitude: up to 1000m

Model Implication

CDL F 8 - 2 / 1

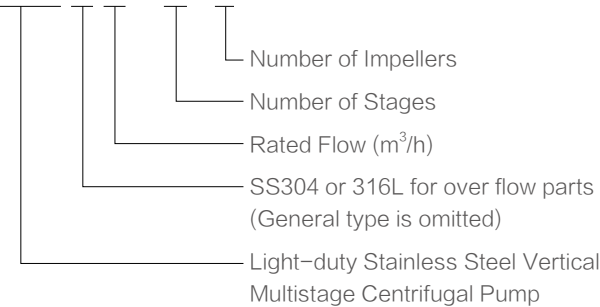

CDL F 32 - 10 - 2

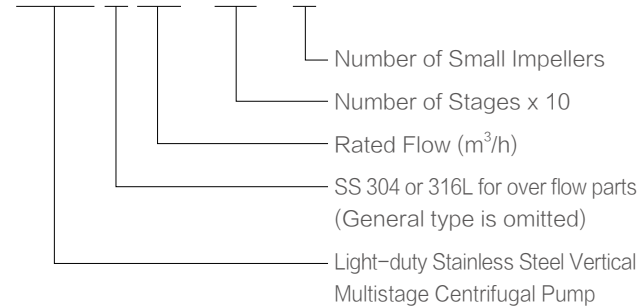

Pump

CDL/CDLF is a non-self-priming vertical multistage centrifugal pump with standard motor.

By a coupling the motor shaft is through the pump head directly connected with the pump shaft, the pressure-resistant cylinder and the over-current component are fixed between the pump head and the water inlet and outlet section by a tie rod bolt. Water inlet and outlet of the pump are on the same straight line at the pump bottom; This pump can be equipped with intelligent protectors as required to effectively protect the pump from dry rotation, phase loss and overload.

Motor

- Motor is a fully enclosed, air-cooled two pole standard motor
- Protection Class : IP55
- Insulation Class: F
- Voltage : 50Hz: 1 × 220-230/240V
3 × 200-220/346-380V
3 × 220-240/380-415V
3 × 380-415V

Ambient Temperature

Max. ambient temperature: +40°C . Ambient temperature above 40°C or installation at altitude of more than 1000 meters above sea level require the use of an oversize motor. Because of low air density and poor cooling effects, the motor output power P2 will be decreased. See the picture.

In such cases, it may be necessary to use a motor with a higher output power rating.

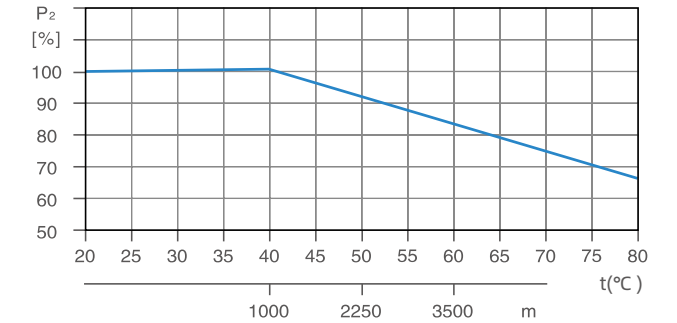

Minimum Inlet Pressure

To avoid cavitation, it is necessary to ensure a minimum pressure on the inlet side of the pump. The maximum suction height "H" can be calculated as follows:

$$H = P_b \times 10.2 - NPSH - H_f - H_v - H_s$$

- **H** is maximum suction head (m)
- **P_b** is atmospheric pressure in bar (Can be set to 1bar, in closed system, P_b is system pressure)
- **NPSH** is the net positive suction head of the pump in m; the corresponding value at maximum flow can be read in the graph
- **H_f** is the suction line resistance loss in m (at the maximum flow of the pump)
- **H_v** is the vaporization pressure in m (can be read from the vaporization pressure gauge. Its value depends on the liquid temperature "tm")
- **H_s** is the minimum safety margin of 0.5m
- If the calculated "H" is positive, the pump can operate at a maximum suction height of "H"
- If the calculated "H" is negative, the pump requires a minimum "H" inlet pressure

It is recommended to calculate the inlet pressure "H" when the following conditions exist:

- High liquid temperature
- The flow is significantly greater than the rated flow
- Pumping water from low
- Pumping water from long pipes
- Poor import conditions

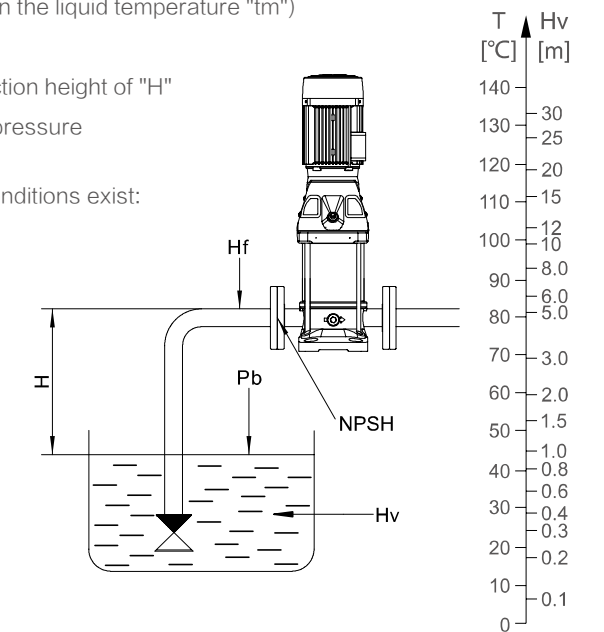

NOTE: To avoid cavitation, the pump should be rated away from the right side of the NPSH curve. Always check the NPSH value of the pump at the highest possible flow.

Scope of Performance

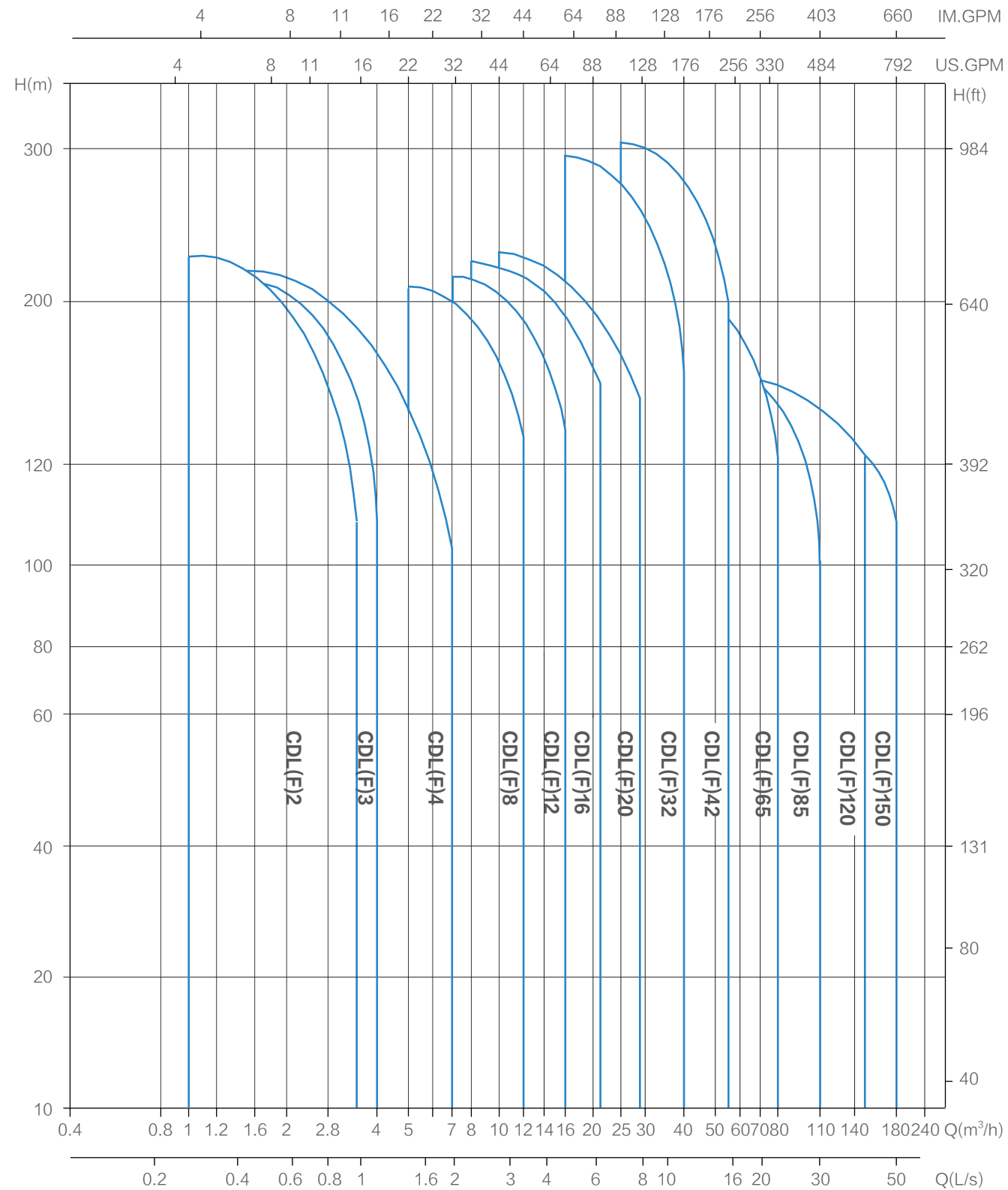

Hydraulic Performance Curves

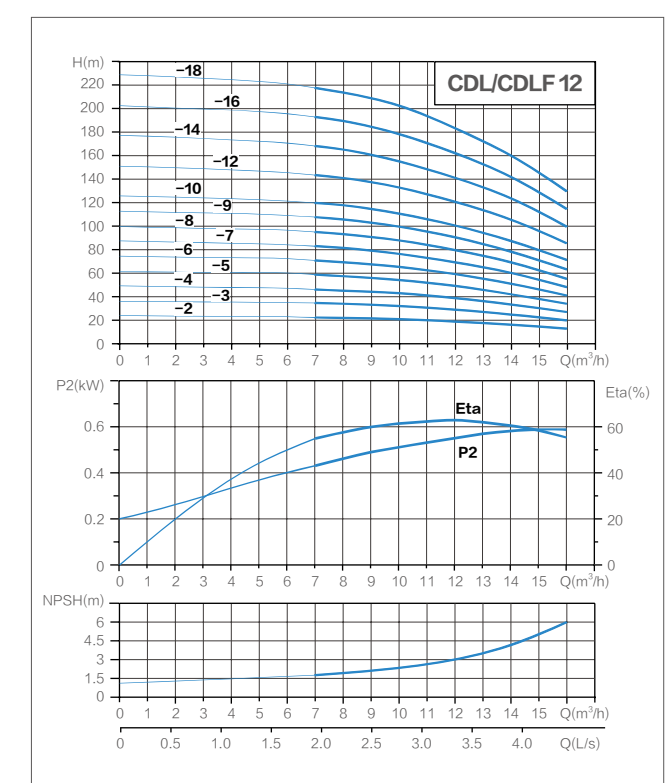
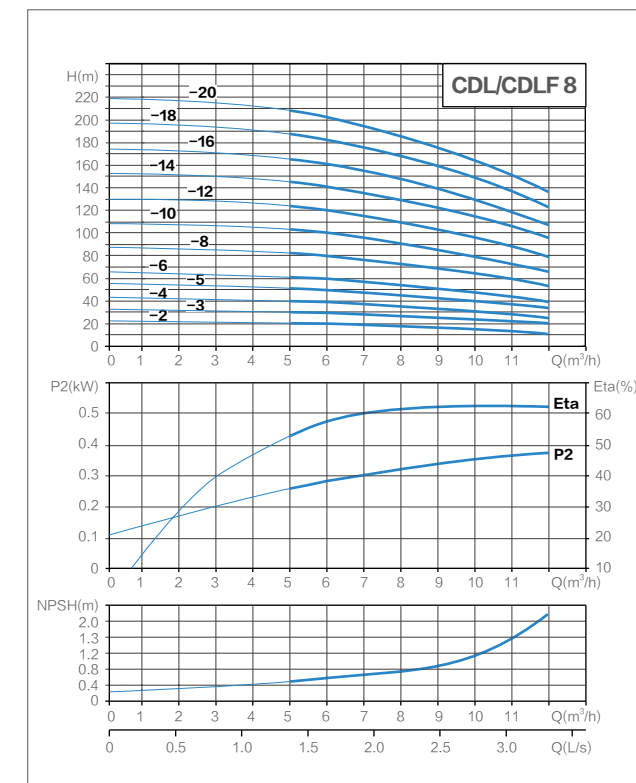
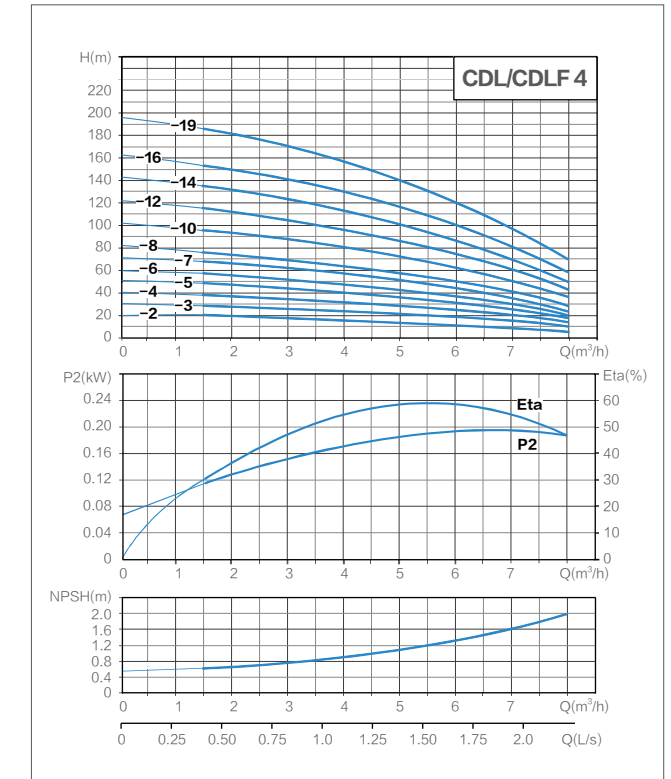
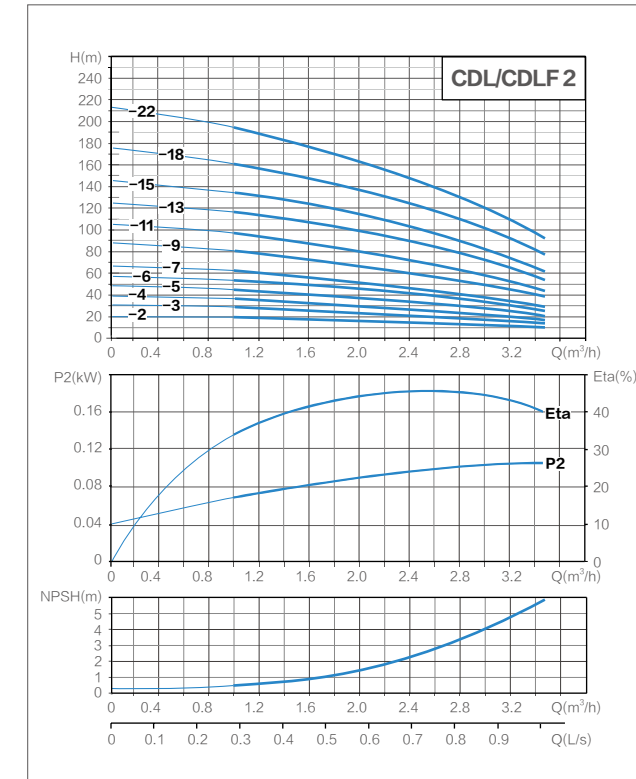

Hydraulic Performance Curves

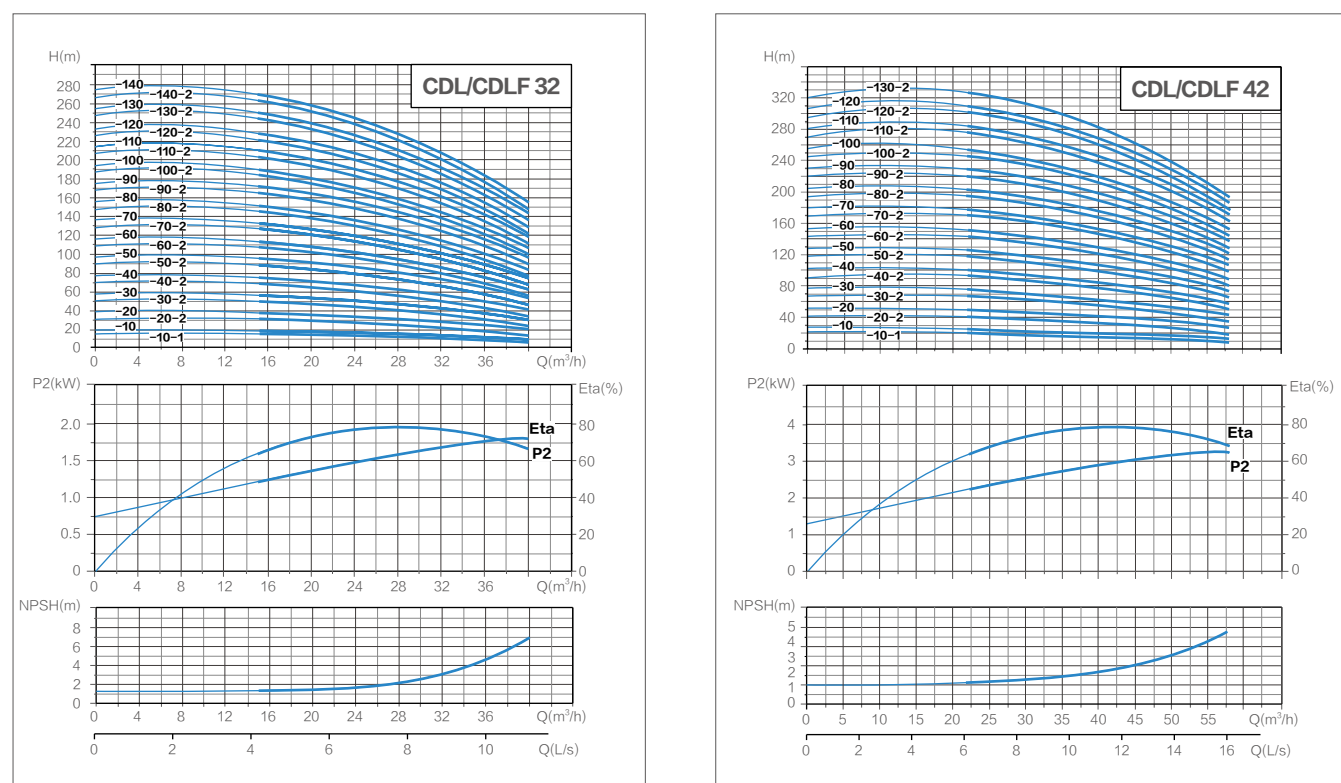
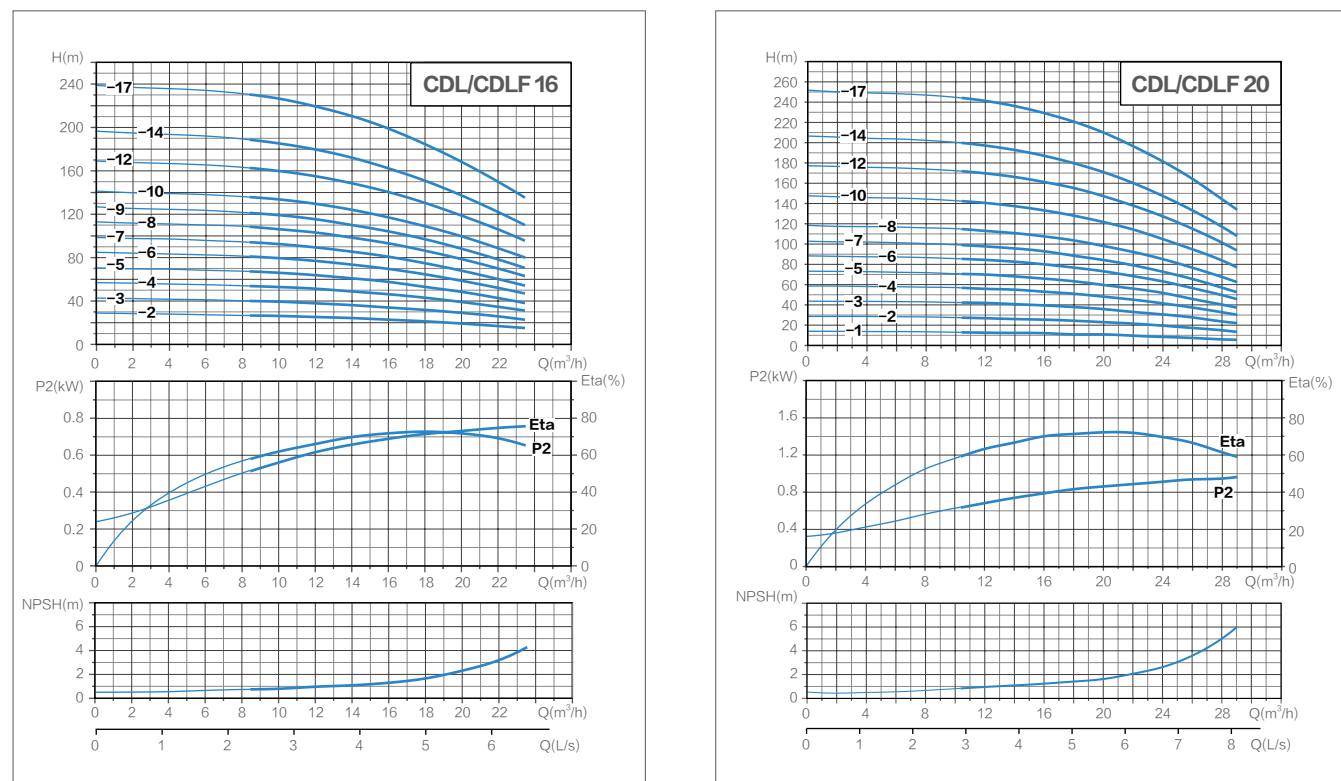

Hydraulic Performance Curves

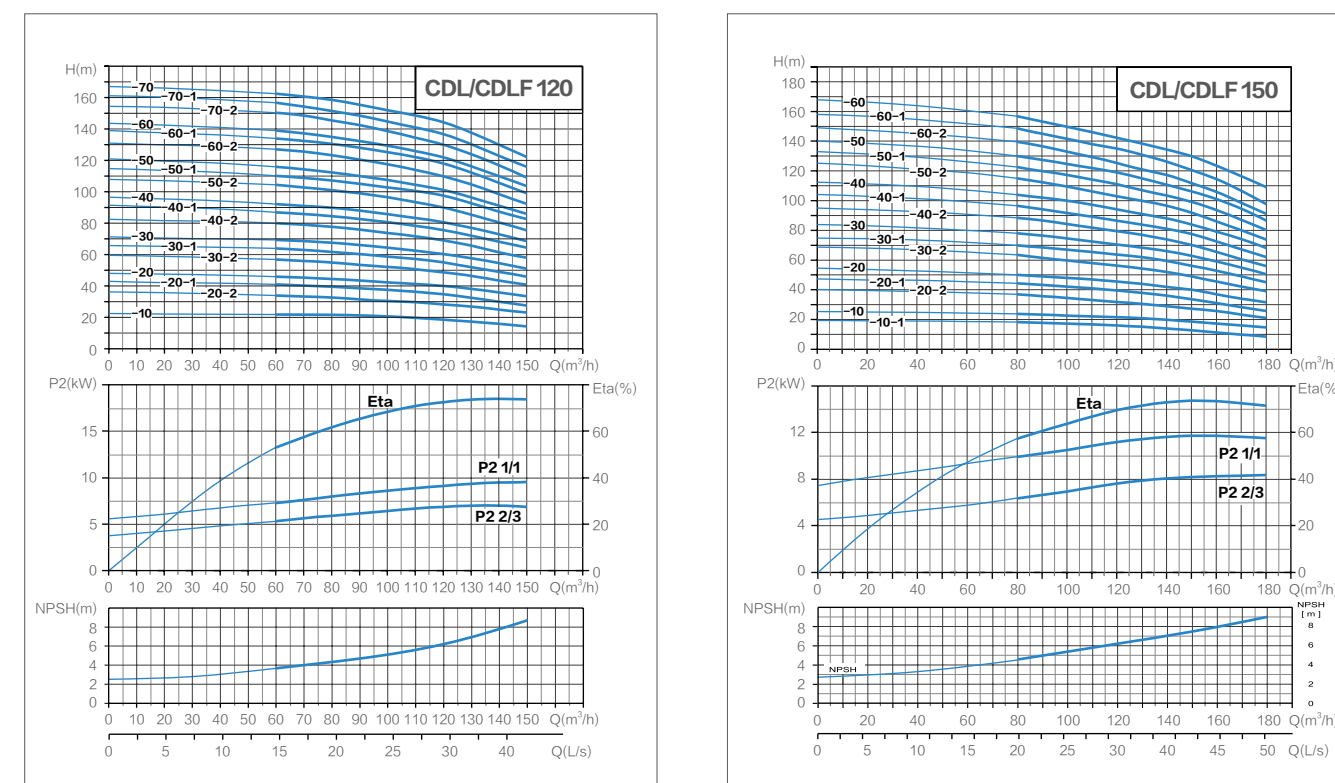
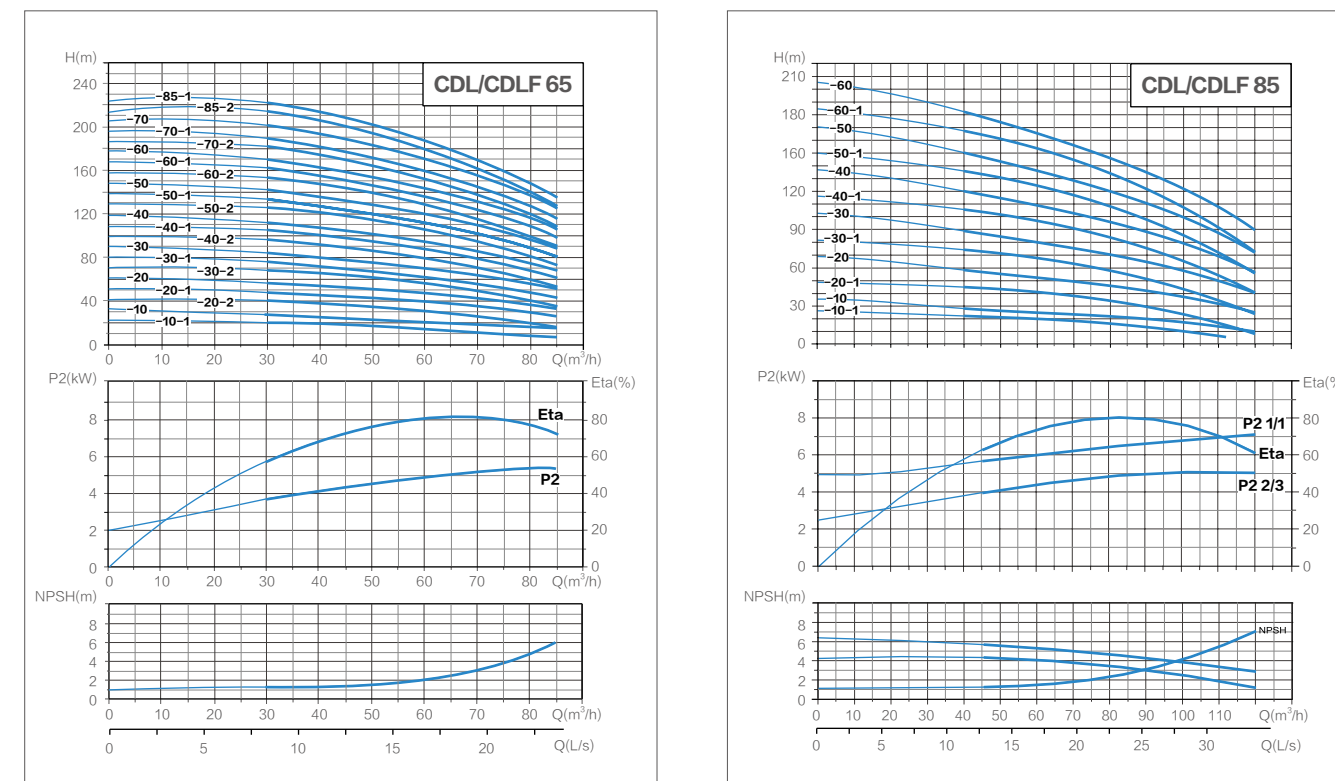

Technical Parameter

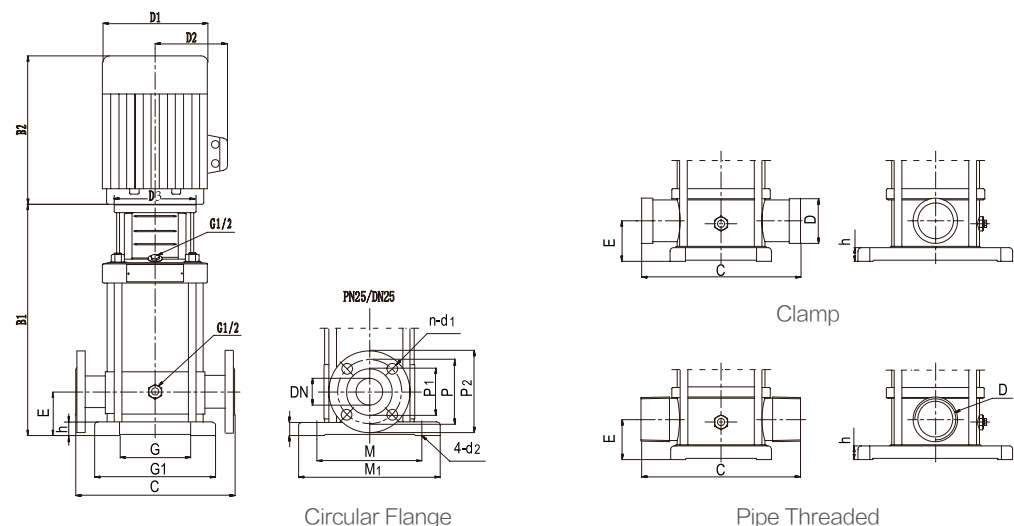

Size	Model	CDL/CDLF											
		2	4	8	12	16	20	32	42	65	85	120	150
Circular Flange Connection	DN	25	32	40	50	65	80	100	125				
	P1	60		80		107		120		150		175	
	P	85	100	110	125		145	160	180		220		
	P2	115	140	150	165		185	200	220		270		
	n-d1	4-Φ14		4-Φ18		8-Φ18		8-Φ28					
	C	250		280		320		365		380		380	
	E	75		86		105		140		180			
	h	32		35		30		45		40			
Nominal Pressure	PN25					PN25-40		PN16		PN25-40			
Clamp Connection	D	42		60		-		-		-		-	
	C	210		260		-		-		-		-	
	E	50		80		90		-		-		-	
	h	20		25		35		-		-		-	
Pipe Threaded Connection	D	ZG1 1/4		ZG2		-		-		-		-	
	C	210		260		-		-		-		-	
	E	50		80		90		-		-		-	
	h	20		25		35		-		-		-	
Waist Flange Connection	D	G1	G1 1/4	G1 1/2	-		-		-		-		
	C	162		200		-		-		-		-	
	E	50		80		-		-		-		-	
	h	20		25		-		-		-		-	
	P	75		100		-		-		-		-	
Foot Connection Siz	n-d1	2-M10×40		2-M12×45		-		-		-		-	
	k	22		-		-		-		-		-	
	G	100		130		170		190		199		275	
Foot Connection Siz	G1	150		199		225		245		255		340	
	M	180		215		240		266		280		380	
	M1	210		247		298		330		348		472	
	d2	13		14		14		18		18		18	

- Pump should be installed in a well-ventilated and anti-freezing place, and the distance between the pump and the motor should be at least 150mm from the obstacle, so that there is enough air around the cooling fan of the motor.
- In order to minimize the friction loss at the inlet, the water inlet pipe should be as short as possible.
- Before installing the pump, check whether the pipeline system is equipped with check valves to prevent liquid backflow. If the pump is used for boiler water supply, a check valve must be installed on the pipeline between the pump and the boiler.
- Pump should be installed on concrete or similar foundation with appropriate height.

Technical Parameter

NO.	Model	Motor		Rated Flow m³/h	Rated Head m	Dimension (mm)					Weight kg
		kW	HP			B1	B2	B1+B2	D1	D2	
1	CDL(F)2-2	0.37	0.5	2 (DN25)	15	258	225	483	148	117	24
2	CDL(F)2-3	0.37	0.5		22	276	225	501	148	117	24
3	CDL(F)2-4	0.55	0.75		30	294	225	519	148	117	25
4	CDL(F)2-5	0.55	0.75		37	312	225	537	148	117	26
5	CDL(F)2-6	0.75	1		45	358	245	603	170	142	30
6	CDL(F)2-7	0.75	1		52	376	245	621	170	142	30
7	CDL(F)2-9	1.1	1.5		67	412	245	657	170	142	33
8	CDL(F)2-11	1.1	1.5		82	448	245	693	170	142	34
9	CDL(F)2-13	1.5	2		98	459	290	749	190	155	40
10	CDL(F)2-15	1.5	2		112	495	290	785	190	155	42
11	CDL(F)2-18	2.2	3		136	554	290	844	190	155	46
12	CDL(F)2-22	2.2	3		165	626	290	916	190	155	47
13	CDL(F)4-2	0.37	0.5	4 (DN32)	15	276	225	501	148	117	22
14	CDL(F)4-3	0.55	0.75		24	303	225	528	148	117	24
15	CDL(F)4-4	0.75	1		32	358	245	603	170	142	30
16	CDL(F)4-5	1.1	1.5		40	385	245	630	170	142	32
17	CDL(F)4-6	1.1	1.5		48	412	245	657	170	142	33
18	CDL(F)4-7	1.5	2		56	414	290	704	190	155	39
19	CDL(F)4-8	1.5	2		64	441	290	731	190	155	40
20	CDL(F)4-10	2.2	3		81	500	290	790	190	155	43
21	CDL(F)4-12	2.2	3		95	554	290	844	190	155	44
22	CDL(F)4-14	3	4		112	628	345	973	197	165	52
23	CDL(F)4-16	3	4		129	684	345	1029	197	165	54
24	CDL(F)4-19	4	5.5		153	788	345	1133	230	188	56
25	CDL(F)8-2	0.75	1	8 (DN40)	18	367	245	612	170	142	33
26	CDL(F)8-3	1.1	1.5		27	397	245	642	170	142	35
27	CDL(F)8-4	1.5	2		36	402	290	692	190	155	42
28	CDL(F)8-5	2.2	3		45	437	290	727	190	155	46
29	CDL(F)8-6	2.2	3		54	467	290	757	190	155	47
30	CDL(F)8-8	3	4		73	527	345	872	197	165	55
31	CDL(F)8-10	4	5.5		92	602	355	957	230	188	67
32	CDL(F)8-12	4	5.5		111	662	355	1017	230	188	70
33	CDL(F)8-14	5.5	7.5		130	727	390	1117	260	208	85
34	CDL(F)8-16	5.5	7.5		148	727	390	1117	260	208	88
35	CDL(F)8-18	7.5	10		167	847	390	1237	260	208	98
36	CDL(F)8-20	7.5	10		186	907	390	1297	260	208	99

Technical Parameter

NO.	Model	Motor		Rated Flow m³/h	Rated Head m	Dimension (mm)					Weight kg	
		kW	HP			B1	B2	B1+B2	D1	D2		
37	CDL(F)12-2	1.5	2	12 (DN50)	20	342	290	632	190	155	40	
38	CDL(F)12-3	2.2	3		30	377	290	667	190	155	45	
39	CDL(F)12-4	3	4		40	407	345	752	197	165	55	
40	CDL(F)12-5	3	4		50	437	345	782	197	165	57	
41	CDL(F)12-6	4	5.5		60	482	355	837	230	188	66	
42	CDL(F)12-7	5.5	7.5		70	517	390	907	260	208	77	
43	CDL(F)12-8	5.5	7.5		80	547	390	937	260	208	78	
44	CDL(F)12-9	5.5	7.5		91	577	390	967	260	208	80	
45	CDL(F)12-10	7.5	10		101	607	390	997	260	208	88	
46	CDL(F)12-12	7.5	10		121	667	390	1057	260	208	92	
47	CDL(F)12-14	11	15		141	835	500	1335	330	255	162	
48	CDL(F)12-16	11	15		162	895	500	1395	330	255	167	
49	CDL(F)12-18	11	15		183	955	500	1455	330	255	168	
50	CDL(F)16-2	2.2	3		16 (DN50)	21.5	377	290	667	190	155	42
51	CDL(F)16-3	3	4	33		422	345	767	197	165	51	
52	CDL(F)16-4	4	5.5	44		482	355	837	230	188	60	
53	CDL(F)16-5	5.5	7.5	55		567	355	922	230	188	62	
54	CDL(F)16-6	5.5	7.5	67		577	390	967	260	208	78	
55	CDL(F)16-7	5.5	7.5	79		622	390	1012	260	208	80	
56	CDL(F)16-8	7.5	10	90		667	390	1057	260	208	86	
57	CDL(F)16-9	7.5	10	103		712	390	1102	260	208	88	
58	CDL(F)16-10	11	15	114		835	500	1335	330	255	166	
59	CDL(F)16-12	11	15	138		925	500	1425	330	255	170	
60	CDL(F)16-14	15	20	160		1015	500	1515	330	255	173	
61	CDL(F)16-14	15	20	160		1105	500	1605	330	255	173	
62	CDL(F)20-2	2.2	3	20 (DN50)		23	377	290	667	190	155	42
63	CDL(F)20-3	4	5.5			35	437	355	792	230	188	58
64	CDL(F)20-4	5.5	7.5		47	487	390	877	230	208	74	
65	CDL(F)20-5	5.5	7.5		58	532	390	922	260	208	75	
66	CDL(F)20-6	7.5	10		70	577	390	967	260	208	84	
67	CDL(F)20-7	7.5	10		82	622	390	1012	260	208	86	
68	CDL(F)20-8	11	15		94	775	500	1275	330	255	157	
69	CDL(F)20-10	11	15		118	865	500	1365	330	255	162	
70	CDL(F)20-12	15	20		142	955	500	1455	330	255	176	
71	CDL(F)20-14	15	20		166	1045	500	1545	330	255	178	
72	CDL(F)20-17	18.5	25		202	1240	500	1740	330	255	201	
73	CDL(F)32-10-1	1.5	2	32 (DN65)	9	495	290	785	190	155	71	
74	CDL(F)32-10	2.2	3		13	495	290	785	190	155	71	
75	CDL(F)32-20-2	3	4		20	575	315	890	197	165	84	
76	CDL(F)32-20	4	5.5		27	600	335	935	230	188	84	
77	CDL(F)32-30-2	5.5	7.5		33	615	430	1045	260	208	95	

Technical Parameter

NO.	Model	Motor		Rated Flow m³/h	Rated Head m	Dimension (mm)					Weight kg
		kW	HP			B1	B2	B1+B2	D1	D2	
78	CDL(F)32-30	5.5	7.5	32 (DN65)	40	615	430	1045	260	208	95
79	CDL(F)32-40-2	7.5	10		46	685	430	1115	260	208	104
80	CDL(F)32-40	7.5	10		53	685	430	1115	260	208	104
81	CDL(F)32-50-2	11	15		60	905	490	1395	330	255	174
82	CDL(F)32-50	11	15		67	905	490	1395	330	255	174
83	CDL(F)32-60-2	11	15		74	975	490	1465	330	255	178
84	CDL(F)32-60	11	15		81	975	490	1465	330	255	178
85	CDL(F)32-70-2	15	20		88	1045	490	1535	330	255	190
86	CDL(F)32-70	15	20		95	1045	490	1535	330	255	190
87	CDL(F)32-80-2	15	20		102	1115	490	1605	330	255	194
88	CDL(F)32-80	15	20		109	1115	490	1605	330	255	194
89	CDL(F)32-90-2	18.5	25		117	1180	550	1730	330	255	220
90	CDL(F)32-90	18.5	25		124	1180	550	1730	330	255	220
91	CDL(F)32-100-2	18.5	25		131	1250	550	1800	330	255	224
92	CDL(F)32-100	18.5	25		138	1250	550	1800	330	255	224
93	CDL(F)32-110-2	22	30		146	1310	590	1900	360	255	261
94	CDL(F)32-110	22	30		153	1310	590	1900	360	255	261
95	CDL(F)32-120-2	22	30		160	1380	590	1970	360	285	265
96	CDL(F)32-120	22	30	167	1380	590	1970	360	285	265	
97	CDL(F)32-130-2	30	40	174	1450	660	2110	400	310	330	
98	CDL(F)32-130	30	40	181	1450	660	2110	400	310	330	
99	CDL(F)32-140-2	30	40	189	1520	660	2180	400	310	337	
100	CDL(F)32-140	30	40	196	1520	660	2180	400	310	337	
101	CDL(F)42-10-1	3	4	42 (DN80)	16	586	315	901	197	165	86
102	CDL(F)42-10	4	5.5		20	586	335	921	230	188	92
103	CDL(F)42-20-2	5.5	7.5		32	611	430	1041	260	208	102
104	CDL(F)42-20	7.5	10		41	611	430	1041	260	208	107
105	CDL(F)42-30-2	11	15		52	841	490	1331	330	255	175
106	CDL(F)42-30	11	15		61	841	490	1331	330	255	175
107	CDL(F)42-40-2	15	20		73	921	490	1411	330	255	187
108	CDL(F)42-40	15	20		81	921	490	1411	330	255	187
109	CDL(F)42-50-2	18.5	25		93	996	550	1546	330	255	208
110	CDL(F)42-50	18.5	25		101	996	550	1546	330	255	208
111	CDL(F)42-60-2	22	30		113	1066	590	1656	360	285	251
112	CDL(F)42-60	22	30		122	1066	590	1656	360	285	251
113	CDL(F)42-70-2	30	40		134	1146	660	1806	400	310	315
114	CDL(F)42-70	30	40		142	1146	660	1806	400	310	315
115	CDL(F)42-80-2	30	40		154	1226	660	1886	400	310	319
116	CDL(F)42-80	30	40		162	1226	660	1886	400	310	319
117	CDL(F)42-90-2	30	40		174	1306	660	1966	400	310	323
118	CDL(F)42-90	37	50		183	1306	660	1966	400	310	343

Technical Parameter

NO.	Model	Motor		Rated Flow m ³ /h	Rated Head m	Dimension (mm)					Weight kg
		kW	HP			B1	B2	B1+B2	D1	D2	
119	CDL(F)42-100-2	37	50	42 (DN80)	194	1386	660	2046	400	310	347
120	CDL(F)42-100	37	50		203	1386	660	2046	400	310	347
121	CDL(F)42-110-2	45	60		217	1471	700	2171	450	345	413
122	CDL(F)42-110	45	60		225	1471	700	2171	450	345	413
123	CDL(F)42-120-2	45	60		238	1551	700	2251	450	345	417
124	CDL(F)42-120	45	60		247	1551	700	2251	450	345	417
125	CDL(F)42-130-2	45	60		259	1631	700	2331	450	345	421
126	CDL(F)65-10-1	4	5.5		65 (DN100)	13	561	335	896	230	188
127	CDL(F)65-10	5.5	7.5	20		531	430	961	260	208	110
128	CDL(F)65-20-2	7.5	10	26		614	430	1044	260	208	120
129	CDL(F)65-20-1	11	15	33		769	490	1259	330	255	155
130	CDL(F)65-20	11	15	40		769	490	1259	330	255	155
131	CDL(F)65-30-2	15	20	46		836	490	1326	330	255	195
132	CDL(F)65-30-1	15	20	53		836	490	1326	330	255	195
133	CDL(F)65-30	18.5	25	60		846	550	1396	330	255	205
134	CDL(F)65-40-2	18.5	25	66		919	550	1469	330	255	208
135	CDL(F)65-40-1	22	30	73		919	590	1509	360	285	260
136	CDL(F)65-40	22	30	80		919	590	1509	360	285	260
137	CDL(F)65-50-2	30	40	88		1001	660	1661	400	310	345
138	CDL(F)65-50-1	30	40	95		1001	660	1661	400	310	345
139	CDL(F)65-50	30	40	102		1001	660	1661	400	310	345
140	CDL(F)65-60-2	30	40	110		1084	660	1744	400	310	350
141	CDL(F)65-60-1	37	50	117		1084	660	1744	400	310	370
142	CDL(F)65-60	37	50	124		1084	660	1744	400	310	370
143	CDL(F)65-70-2	37	50	132		1166	660	1826	500	310	375
144	CDL(F)65-70-1	37	50	139		1166	660	1826	400	310	375
145	CDL(F)65-70	45	60	146		1171	700	1871	440	310	435
146	CDL(F)65-85-2	45	60	154	1248	700	1948	460	340	440	
147	CDL(F)65-85-1	45	60	161	1248	700	1948	460	340	440	
148	CDL(F)85-10-1	5.5	7.5	85 (DN100)	14	541	430	971	260	208	120
149	CDL(F)85-10	7.5	10		20	541	430	971	260	208	122
150	CDL(F)85-20-2	11	15		30	788	490	1278	330	255	165
151	CDL(F)85-20	15	20		41	788	490	1278	330	255	198
152	CDL(F)85-30-2	18.5	25		52	865	550	1415	330	255	212
153	CDL(F)85-30	22	30		64	865	590	1455	360	285	265
154	CDL(F)85-40-2	30	40		75	957	660	1617	400	310	348
155	CDL(F)85-40	30	40		86	957	660	1617	400	310	348
156	CDL(F)85-50-2	37	50		98	1049	660	1709	400	310	375
157	CDL(F)85-50	37	50		110	1049	660	1709	400	310	375
158	CDL(F)85-60-2	45	60		122	1146	700	1846	460	340	438
159	CDL(F)85-60	45	60	134	1146	700	1846	460	340	438	

Technical Parameter

NO.	Model	Motor		Rated Flow m ³ /h	Rated Head m	Dimension (mm)					Weight kg
		kW	HP			B1	B2	B1+B2	D1	D2	
160	CDL(F)120-10	11	15	120 (DN125)	18.5	840	490	1330	330	255	230
161	CDL(F)120-20-2	15	20		28.5	1000	490	1490	330	255	245
162	CDL(F)120-20-1	18.5	25		34.5	1000	550	1550	330	255	250
163	CDL(F)120-20	22	30		40	1000	590	1590	360	285	285
164	CDL(F)120-30-2	30	40		49	1160	660	1820	400	310	360
165	CDL(F)120-30-1	30	40		55.5	1160	660	1820	400	310	360
166	CDL(F)120-30	30	40		61	1160	660	1820	400	310	360
167	CDL(F)120-40-2	37	50		69	1320	660	1980	400	310	400
168	CDL(F)120-40-1	37	50		76	1320	660	1980	400	310	400
169	CDL(F)120-40	45	60		81	1320	700	2020	460	340	460
170	CDL(F)120-50-2	45	60		90	1480	700	2180	460	340	470
171	CDL(F)120-50-1	45	60		97	1480	700	2180	460	340	470
172	CDL(F)120-50	55	75		101.5	1510	770	2280	540	370	575
173	CDL(F)120-60-2	55	75		110	1670	770	2440	540	370	585
174	CDL(F)120-60-1	55	75		118	1670	770	2440	540	370	585
175	CDL(F)120-60	75	100		123	1670	845	2515	580	410	705
176	CDL(F)120-70-2	75	100		130	1830	845	2675	580	410	715
177	CDL(F)120-70-1	75	100		137.5	1830	845	2675	580	410	715
178	CDL(F)120-70	75	100		145	1830	845	2675	580	410	715
179	CDL(F)150-10-1	11	15	150 (DN125)	12.5	840	490	1330	330	255	230
180	CDL(F)150-10	15	20		18.5	840	490	1330	330	255	235
181	CDL(F)150-20-2	18.5	25		27.5	1000	550	1550	330	255	250
182	CDL(F)150-20-1	22	30		35	1000	590	1590	360	285	295
183	CDL(F)150-20	30	40		40	1000	660	1660	400	310	350
184	CDL(F)150-30-2	30	40		49	1160	660	1820	400	310	360
185	CDL(F)150-30-1	37	50		56	1160	660	1820	400	310	360
186	CDL(F)150-30	37	50		63	1160	660	1820	400	310	385
187	CDL(F)150-40-2	45	60		70.5	1320	700	2020	460	340	460
188	CDL(F)150-40-1	45	60		77	1320	700	2020	460	340	460
189	CDL(F)150-40	55	75		84	1350	770	2120	540	370	560
190	CDL(F)150-50-2	55	75		92	1510	770	2280	540	370	570
191	CDL(F)150-50-1	75	100		99	1510	845	2355	580	410	690
192	CDL(F)150-50	75	100		106.5	1510	845	2355	580	410	690
193	CDL(F)150-60-2	75	100		112	1670	845	2515	580	410	700
194	CDL(F)150-60-1	75	100		120.5	1670	845	2515	580	410	700
195	CDL(F)150-60	75	100		130	1670	845	2515	580	410	700

DGWQ

Double-Knife High Head Cutting Submersible Sewage Pumps



Product Features

- Independent product research and development, patent structure and appearance intellectual property rights.
- Both internal and external knives cut at the same time, which can easily solve the jam problem of the card machine.
- Adjustable clearance of external cutter can improve chip performance, facilitate replacement and reduce cost at the same time.
- Unique anti-clogging design of the pump casing enhances the water flow passability inside the pump casing and makes the pumping and discharging process smoother.
- Pump is equipped with protectors to effectively protect the safety of the motor.
- High-grade nodular cast iron impeller and high-hardness alloy cutting disk are adopted, which will improve the wear-resistant effect and maintain the high-end chip performance when used in harsh working conditions.
- Motor shaft is made of 304 stainless steel with alloy combination mechanical seal, which greatly improves the wear resistance and sealing reliability.

Model Implication

50 DG WQ 10-10-0.75

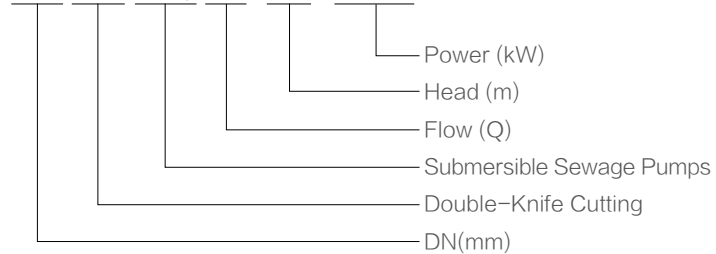

Dimensions

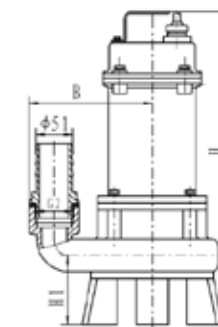

Hydraulic Performance Curves

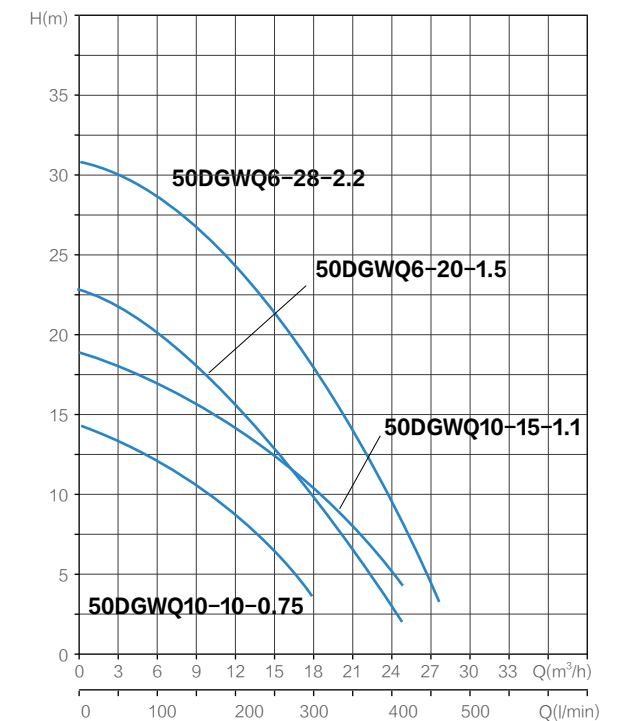

Technical Parameter

NO.	Model	Voltage	Rated Flow	Rated Head	Power		DN	Speed	Dimensions(mm)		
		V	m³/h	m	kW	HP			mm	min	B
1	50DGWQ10-10-0.75	380	10	10	0.75	1	50	2900	150	535	116
2	50DGWQ10-15-1.1	380	10	15	1.1	1.5	50	2900	150	550	116
3	50DGWQ6-20-1.5	380	6	20	1.5	2	50	2900	155	600	125
4	50DGWQ6-28-2.2	380	6	28	2.2	3	50	2900	155	600	125

WQ(D)/JYWQ

Submersible Sewage Pump



Sewage water



Agricultural



Civil use



Industrial use



Product Summary

WQ(D)/JYWQ sewage submersible electric pump consists of pump, seal and motor. Motor is a three-phase and-asynchronous motor and is located at the upper part of the electric pump. Pump body is located at the lower part of the electric pump, which is of non-clogging runner impeller volute structure; Alloy double-end mechanical seal is used between pump and motor, and "O" type oilresistant rubber sealing ring is used as static seal at each fixed stop seal. The whole pump adopts stainless steel screws.

Main Application

This series are widely used in industry, agriculture, mining, construction, municipal environmental protection and other places. It can pump mud, mortar, domestic wastewater, sewage feces and liquids containing short fibers, paper scraps, silt and other solid particles. It is ideal water conservancy equipment for irrigation and drainage and river pond dredging, but not suitable for use in environments with explosion-proof requirements.

Operating Conditions

This pump can work continuously and normally under the following service conditions:

- Medium temperature doesn't exceed+40°C
- PH value of the medium is between 4 and 10
- Density of the medium is not more than $1.2 \times 10^3 \text{kg/m}^3$
- Diving depth is less than 5m

Model Implication

WQ D 10 - 10 - 0.75

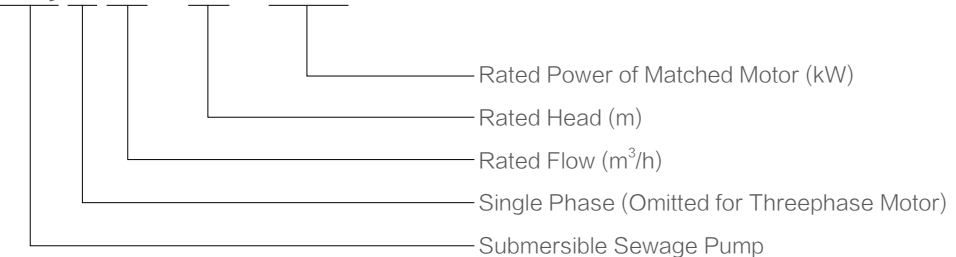

Hydraulic Performance Curves

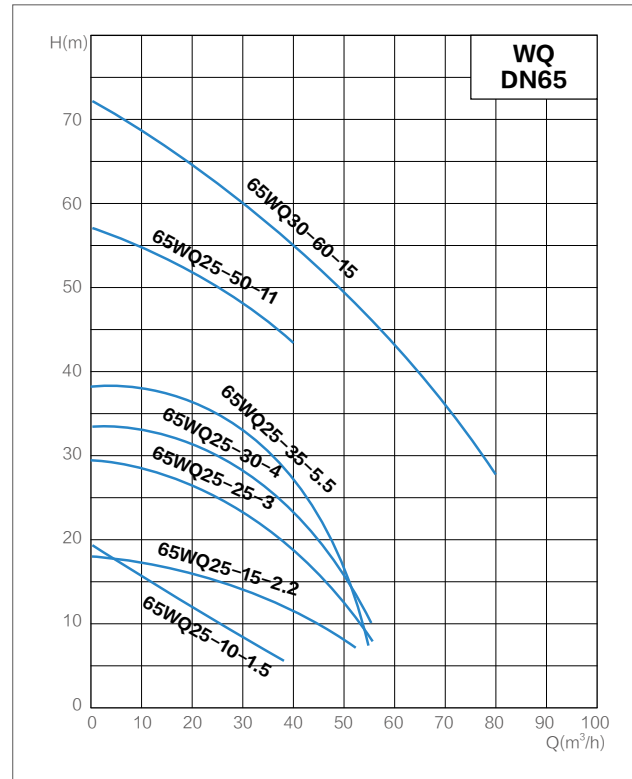
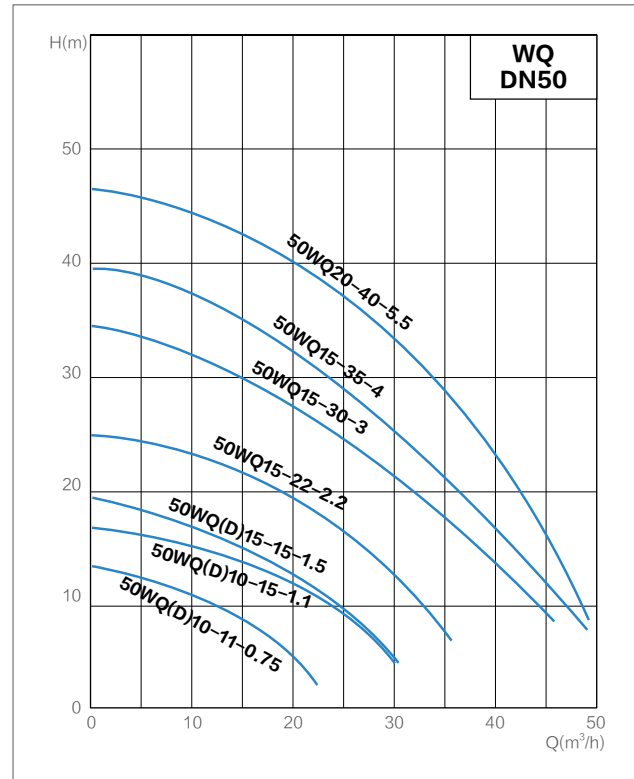

Hydraulic Performance Curves

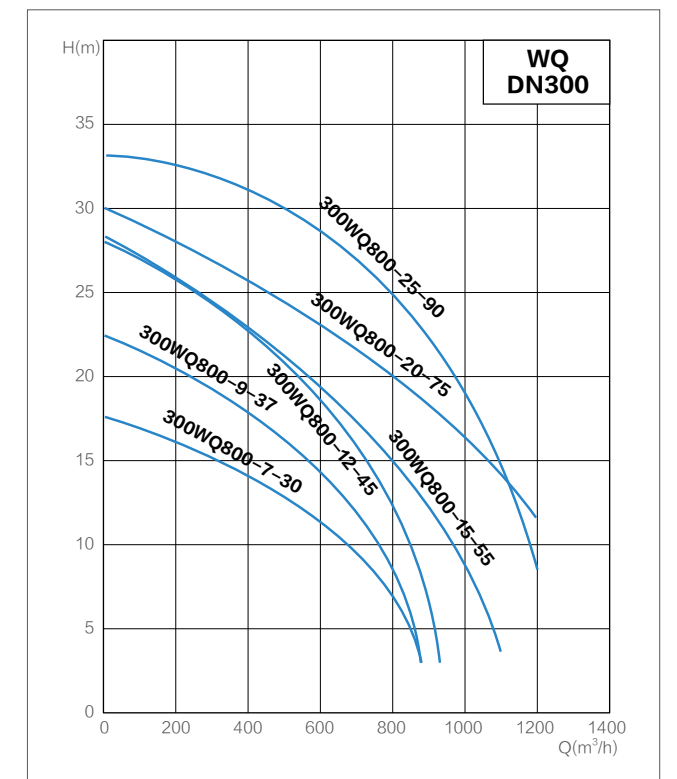
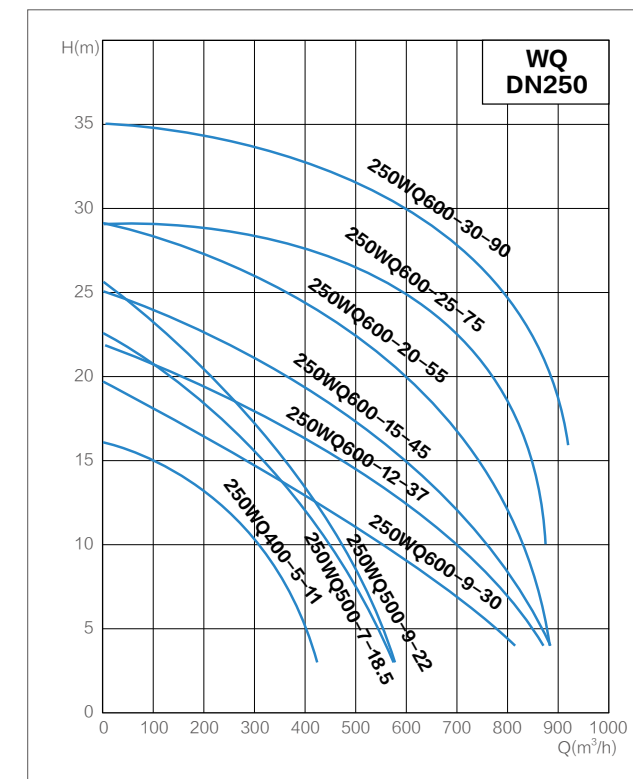
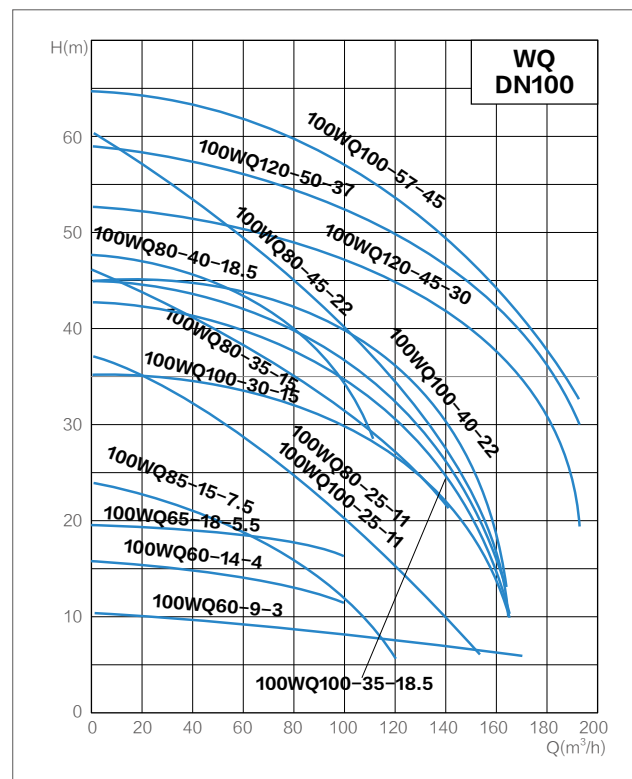
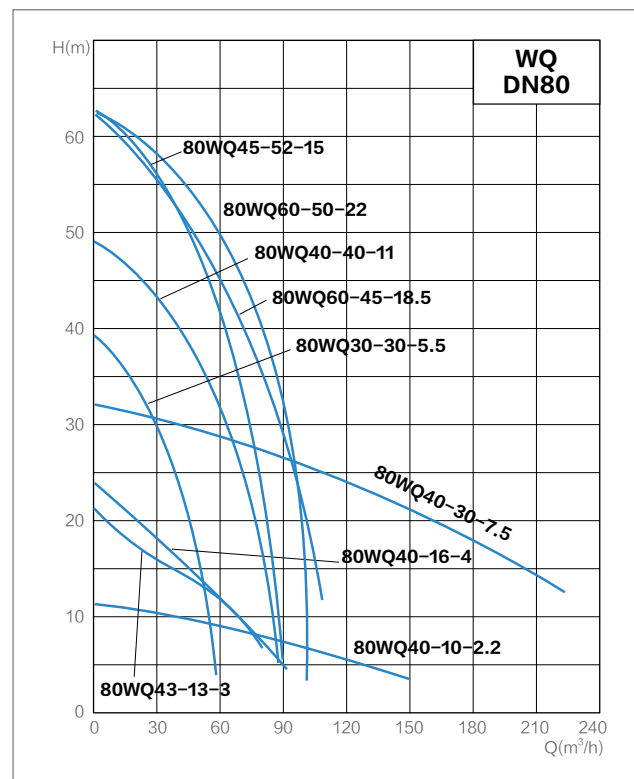
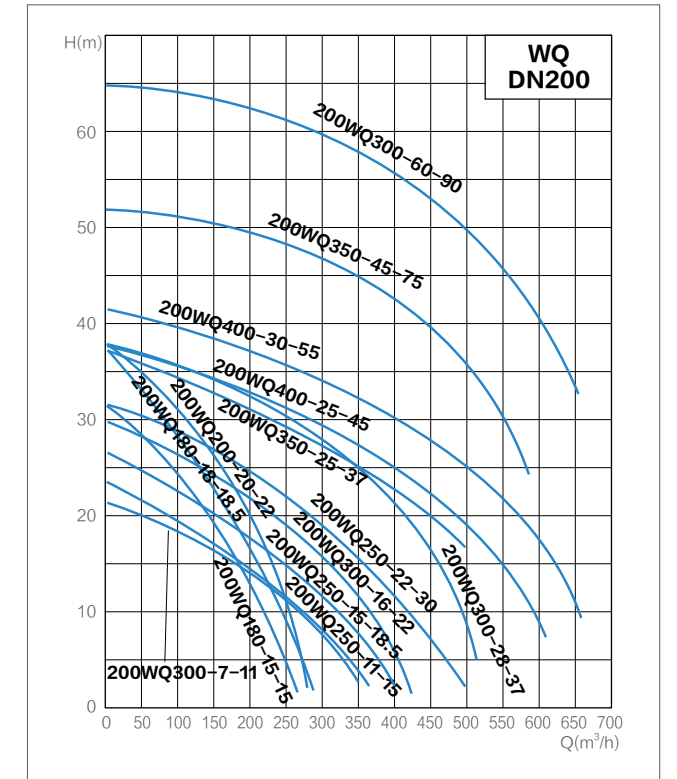
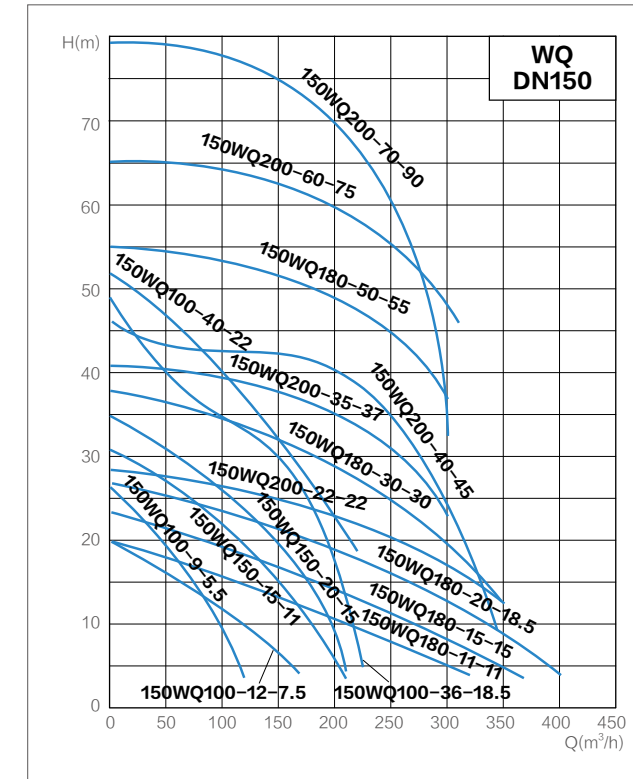

Hydraulic Performance Curves

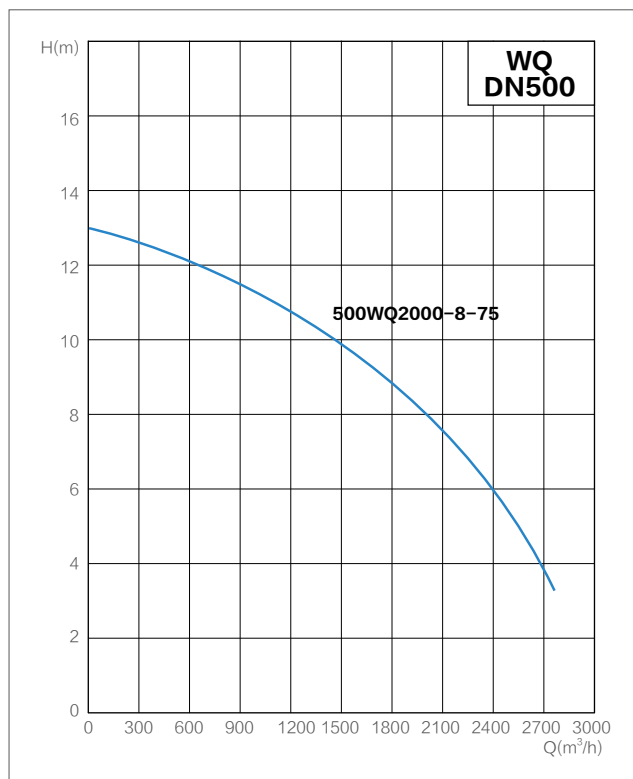
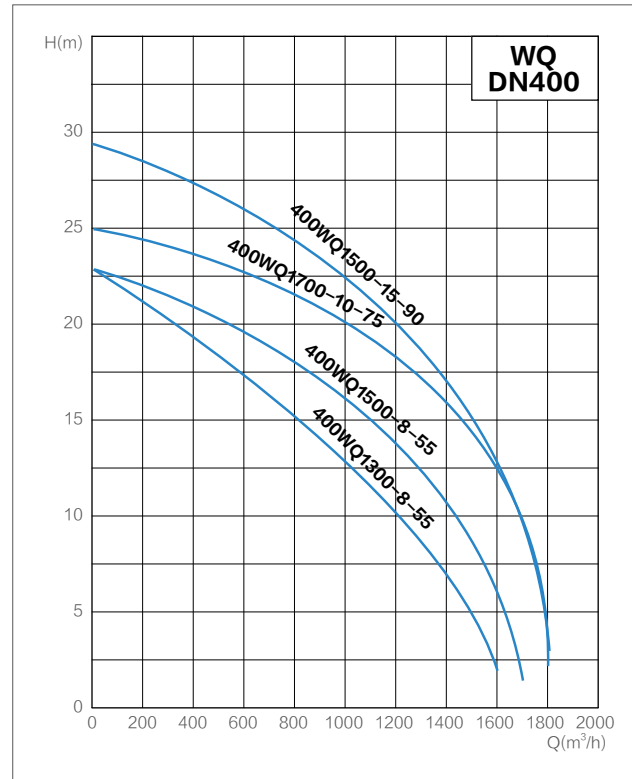
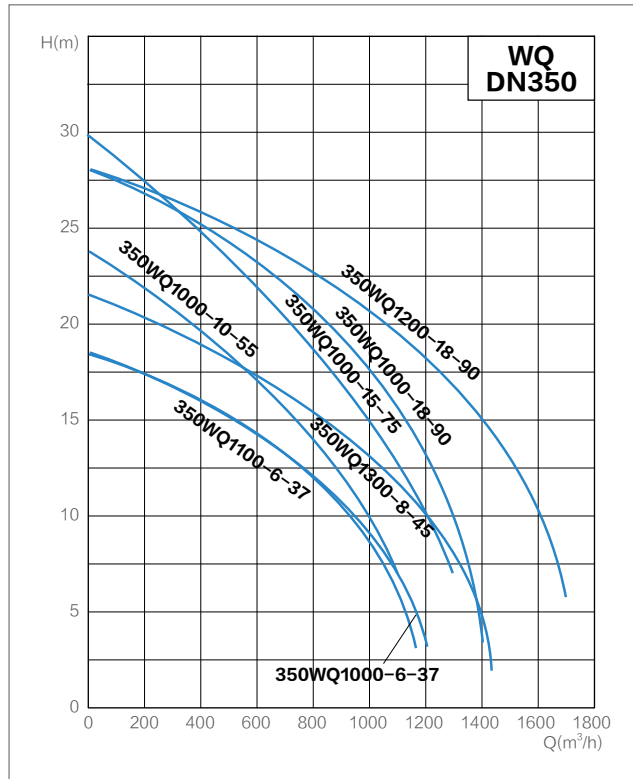

Technical Parameter-2P

Model	Power	Voltage	Rated Flow	Rated Head	Speed	DN
	kW	V	m³/h	m	r/min	Inch/mm
50WQ(D)10-11-0.75	0.75	220/380	10	11	2860	2/50
50WQ(D)10-15-1.1	1.1	220/380	10	15	2860	2/50
50WQ(D)15-15-1.5	1.5	220/380	15	15	2860	2/50
50WQ15-22-2.2	2.2	380	15	22	2860	2/50
50WQ15-30-3	3.0	380	15	30	2860	2/50
50WQ15-35-4	4.0	380	15	35	2860	2/50
50WQ20-40-5.5	5.5	380	20	40	2860	2/50
50WQ20-80-18.5	18.5	380	20	80	2860	2/50
50WQ20-90-22	22	380	20	90	2860	2/50
65WQ25-10-1.5	1.5	380	25	10	2860	2.5/65
65WQ25-15-2.2	2.2	380	25	15	2860	2.5/65
65WQ25-25-3	3.0	380	25	25	2860	2.5/65
65WQ25-30-4	4.0	380	25	30	2860	2.5/65
65WQ25-35-5.5	5.5	380	25	35	2860	2.5/65
65WQ25-50-11	11	380	25	50	2860	2.5/65
65WQ30-60-15	15	380	30	60	2860	2.5/65
65WQ30-68-18.5	18.5	380	30	68	2860	2.5/65
65WQ30-75-22	22	380	30	75	2860	2.5/65
80WQ40-10-2.2	2.2	380	40	10	2860	3/80
80WQ40-13-3	3.0	380	40	13	2860	3/80
80WQ40-16-4	4.0	380	40	16	2860	3/80
80WQ30-30-5.5	5.5	380	30	30	2860	3/80
80WQ40-30-7.5	7.5	380	40	30	2860	3/80
80WQ40-40-11	11	380	40	40	2860	3/80
80WQ45-52-15	15	380	45	52	2860	3/80
80WQ60-45-18.5	18.5	380	60	45	2860	3/80
80WQ60-50-22	22	380	60	50	2860	3/80
100WQ60-9-3	3.0	380	60	9	2860	4/100
100WQ60-14-4	4.0	380	60	14	2860	4/100
100WQ65-18-5.5	5.5	380	65	18	2860	4/100
100WQ85-15-7.5	7.5	380	85	15	2860	4/100
100WQ80-25-11	11	380	80	25	2860	4/100
100WQ80-35-15	15	380	80	35	2860	4/100
100WQ80-40-18.5	18.5	380	80	40	2860	4/400
100WQ80-45-22	22	380	80	45	2860	4/400
150WQ100-9-5.5	5.5	380	100	9	2860	6/150
150WQ100-12-7.5	7.5	380	100	12	2860	6/150
150WQ150-15-11	11	380	150	15	2860	6/150
150WQ150-20-15	15	380	150	20	2860	6/150
150WQ100-36-18.5	18.5	380	100	36	2860	6/150
150WQ100-40-22	22	380	100	40	2860	6/150
200WQ180-15-15	15	380	180	15	2860	8/200
200WQ180-18-18.5	18.5	380	180	18	2860	8/200
200WQ200-20-22	22	380	200	20	2860	8/200

Technical Parameter-4P~6P

Model	Power	Voltage	Rated Flow	Rated Head	Speed	DN
	kW	V	m ³ /h	m	r/min	Inch/mm
100WQ100-25-11	11	380	100	25	1450	4/100
100WQ100-30-15	15	380	100	30	1450	4/100
100WQ100-35-18.5	18.5	380	100	35	1450	4/100
100WQ100-40-22	22	380	100	40	1450	4/100
100WQ120-45-30	30	380	120	45	1450	4/100
100WQ120-50-37	37	380	120	50	1450	4/100
100WQ100-57-45	45	380	100	57	1450	4/100
100WQ100-65-55	55	380	100	65	1450	4/100
100WQ120-75-75	75	380	120	75	1450	4/100
100WQ120-85-90	90	380	120	85	1450	4/100
150WQ180-11-11	11	380	180	11	1450	6/150
150WQ180-15-15	15	380	180	15	1450	6/150
150WQ180-20-18.5	18.5	380	180	20	1450	6/150
150WQ200-22-22	22	380	200	22	1450	6/150
150WQ180-30-30	30	380	180	30	1450	6/150
150WQ200-35-37	37	380	200	35	1450	6/150
150WQ180-50-55	55	380	180	50	1450	6/150
150WQ200-40-45	45	380	200	40	1450	6/150
150WQ200-60-75	75	380	200	60	1450	6/150
150WQ200-70-90	90	380	200	70	1450	6/150
200WQ300-7-11	11	380	300	7	1450	8/200
200WQ250-11-15	15	380	250	11	1450	8/200
200WQ250-15-18.5	18.5	380	250	15	1450	8/200
200WQ350-10-18.5	18.5	380	350	10	1450	8/200
200WQ300-16-22	22	380	300	16	1450	8/200

Technical Parameter-4P~6P

Model	Power	Voltage	Rated Flow	Rated Head	Speed	DN
	kW	V	m ³ /h	m	r/min	Inch/mm
200WQ250-22-30	30	380	250	22	1450	8/200
200WQ300-28-37	37	380	300	28	1450	8/200
200WQ350-25-37	37	380	350	25	1450	8/200
200WQ300-40-55	55	380	300	40	1450	8/200
200WQ400-30-55	55	380	400	30	1450	8/200
200WQ300-32-45	45	380	300	32	1450	8/200
200WQ400-25-45	45	380	400	25	1450	8/200
200WQ350-45-75	75	380	350	45	1450	8/200
200WQ300-60-90	90	380	300	60	1450	8/200
200WQ400-50-90	90	380	400	50	1450	8/200
250WQ400-5-11	11	380	400	5	1450	10/250
250WQ500-5-15	15	380	500	5	1450	10/250
250WQ500-7-18.5	18.5	380	500	7	1450	10/250
250WQ500-9-22	22	380	500	9	1450	10/250
250WQ500-12-30	30	380	500	12	1450	10/150
250WQ-600-9-30	30	380	600	9	1450	10/250
250WQ600-12-37	37	380	600	12	1450	10/250
250WQ600-15-45	45	380	600	15	1450	10/250
250WQ600-20-55	55	380	600	20	1450	10/250
250WQ600-25-75	75	380	600	25	1450	10/250
250WQ600-30-90	90	380	600	30	1450	10/250
300WQ650-5-18.5	18.5	380	650	5	1450	12/300
300WQ650-7-22	22	380	650	7	1450	12/300
300WQ800-7-30	30	380	850	7	1450	12/300
300WQ800-9-37	37	380	800	9	1450	12/300

Technical Parameter-4P~6P

Model	Power	Voltage	Rated Flow	Rated Head	Speed	DN
	kW	V	m ³ /h	m	r/min	Inch/mm
300WQ800-12-45	45	380	800	12	1450	12/300
300WQ800-15-55	55	380	800	15	1450	12/300
300WQ800-20-75	75	380	800	20	1450	12/300
300WQ800-25-90	90	380	800	25	1450	12/300
350WQ1000-6-37	37	380	1000	6	1450	14/350
350WQ1200-8-45	45	380	1200	8	1450	14/350
350WQ1000-10-55	55	380	1000	10	1450	14/350
350WQ1000-15-75	75	380	1000	15	1450	14/350
350WQ1000-18-90	90	380	1000	18	1450	14/350
400WQ1300-8-55	55	380	1300	8	1450	16/400
400WQ1300-13-75	75	380	1300	13	1450	16/400
400WQ1300-16-90	90	380	1300	16	1450	16/400
350WQ1100-6-37	37	380	1100	6	980	14/350
400WQ1300-5-37	37	380	1300	5	980	14/350
350WQ1300-8-45	45	380	1300	8	980	16/400
400WQ1700-6-45	45	380	1700	6	980	14/350
400WQ1500-8-55	55	380	1500	8	980	16/400
500WQ2200-5-55	55	380	2200	5	980	16/400
350WQ1500-12-75	75	380	1500	12	980	20/500
400WQ1700-10-75	75	380	1700	10	980	14/350
500WQ2000-8-75	75	380	2000	8	980	16/400
350WQ1200-18-90	90	380	1200	18	980	20/500
400WQ1500-15-90	90	380	1500	15	980	14/350
500WQ2000-10-90	90	380	2000	10	980	16/400

Dimensions-2P

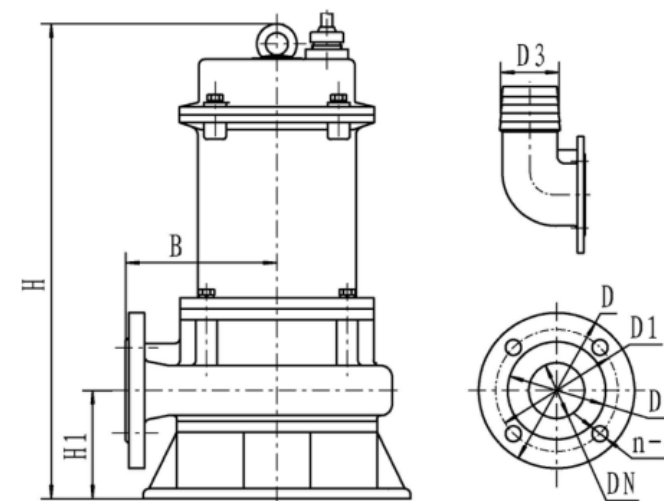

Model	B	H	H1	D	D1	D2	D3	DN (Inch/mm)	n-d
50WQ(D)10-11-0.75	137	560	110	140	110	90	50	2/50	4-Φ14
50WQ(D)10-15-1.1	137	560	114	140	110	90	50	2/50	4-Φ14
50WQ(D)15-15-1.5	139	600	114	140	110	90	50	2/50	4-Φ14
50WQ15-22-2.2	151	600	120	140	110	90	50	2/50	4-Φ14
50WQ15-30-3	153	650	125	140	110	90	50	2/50	4-Φ14
50WQ15-35-4	169	700	135	140	110	90	50	2/50	4-Φ14
50WQ20-40-5.5	179	750	135	140	110	90	50	2/50	4-Φ14
50WQ20-80-18.5	240	1150	200	140	110	90	50	2/50	4-Φ14
50WQ20-90-22	240	1200	200	140	110	90	50	2/50	4-Φ14
65WQ25-10-1.5	143	600	114	160	130	110	64	2.5/65	4-Φ14
65WQ25-15-2.2	160	600	120	160	130	110	64	2.5/65	4-Φ14
65WQ25-25-3	150	650	125	160	130	110	64	2.5/65	4-Φ14
65WQ25-30-4	168	700	135	160	130	110	64	2.5/65	4-Φ14
65WQ25-35-5.5	168	750	135	160	130	110	64	2.5/65	4-Φ14
65WQ25-50-11	220	1000	180	160	130	110	64	2.5/65	4-Φ14
65WQ30-60-15	220	1050	180	160	130	110	64	2.5/65	4-Φ14
65WQ30-68-18.5	240	1150	200	160	130	110	64	2.5/65	4-Φ14

Dimensions-2P

Model	B	H	H1	D	D1	D2	D3	DN (Inch/mm)	n-d
65WQ30-75-22	240	1200	200	160	130	110	64	2.5/65	4-Φ14
80WQ40-10-2.2	167	600	120	190	150	126	76	3/80	4-Φ14
80WQ40-13-3	150	650	125	190	150	126	76	3/80	4-Φ14
80WQ40-16-4	170	700	135	190	150	126	76	3/80	4-Φ14
80WQ30-30-5.5	170	750	135	190	150	126	76	3/80	4-Φ18
80WQ40-30-7.5	200	750	170	190	150	126	76	3/80	4-Φ18
80WQ40-40-11	200	1000	180	190	150	126	76	3/80	4-Φ18
80WQ45-52-15	220	1050	180	190	150	126	76	3/80	4-Φ18
80WQ60-45-18.5	250	1150	200	190	150	126	76	3/80	4-Φ18
80WQ60-50-22	250	1200	200	190	150	126	76	3/80	4-Φ18
100WQ60-9-3	178	650	125	210	170	148	100	4/100	4-Φ18
100WQ60-14-4	178	700	150	210	170	148	100	4/100	4-Φ18
100WQ65-18-5.5	178	750	150	210	170	148	100	4/100	4-Φ18
100WQ85-15-7.5	200	750	170	210	170	148	100	4/100	4-Φ18
100WQ80-25-11	220	1000	240	210	170	148	100	4/100	4-Φ18
100WQ80-35-15	220	1050	240	210	170	148	100	4/100	4-Φ18
100WQ80-40-18.5	260	1150	210	210	170	148	100	4/100	4-Φ18
100WQ80-45-22	260	1200	210	210	170	148	100	4/100	4-Φ18
150WQ100-9-5.5	200	750	210	265	225	206	150	6/150	8-Φ18
150WQ100-12-7.5	200	750	170	265	225	206	150	6/150	8-Φ18
150WQ150-15-11	280	1000	200	265	225	206	150	6/150	8-Φ18
150WQ150-20-15	280	1050	200	265	225	206	150	6/150	8-Φ18
150WQ100-36-18.5	280	1150	200	265	225	206	150	6/150	8-Φ18
150WQ100-40-22	280	1200	200	265	225	206	150	6/150	8-Φ18
200WQ180-15-15	280	1050	200	265	225	206	200	8/200	8-Φ18
200WQ180-18-18.5	280	1150	200	265	225	206	200	8/200	8-Φ18
200WQ200-20-22	280	1200	200	265	225	206	200	8/200	8-Φ18

Dimensions-4P~6P

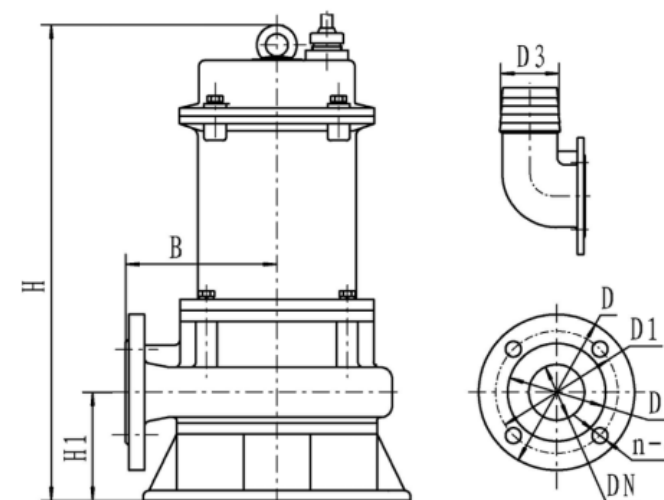

Model	B	H	H1	D	D1	D2	D3	DN (Inch/mm)	n-d
100WQ100-25-11	269	910	189	210	170	144	100	4/100	4-Φ18
100WQ100-30-15	272	949	184	210	170	144	100	4/100	4-Φ18
100WQ100-35-18.5	314	1191	188	210	170	144	100	4/100	4-Φ18
100WQ100-40-22	314	1217	188	210	170	144	100	4/100	4-Φ18
100WQ120-45-30	386	1490	270	210	170	144	100	4/100	4-Φ18
100WQ120-50-37	325	1408	270	210	170	144	100	4/100	4-Φ18
100WQ100-57-45	303	1490	270	210	170	144	100	4/100	4-Φ18
100WQ100-65-55	365	1560	270	210	170	144	100	4/100	4-Φ18
100WQ120-75-75	426	1710	336	210	170	144	100	4/100	4-Φ18
100WQ120-85-90	427	1630	150	210	170	144	100	4/100	4-Φ18
150WQ180-11-11	310	1000	280	265	225	200	150	6/150	8-Φ18
150WQ180-15-15	310	1080	280	265	225	200	150	6/150	8-Φ18
150WQ180-20-18.5	310	1238	223	265	225	200	150	6/150	8-Φ18
150WQ200-22-22	310	1324	310	265	225	200	150	6/150	8-Φ18
150WQ180-30-30	349	1398	335	265	225	200	150	6/150	8-Φ18
150WQ200-35-37	349	1368	235	265	225	200	150	6/150	8-Φ18

Dimensions-4P~6P

Model	B	H	H1	D	D1	D2	D3	DN (Inch/mm)	n-d
150WQ180-50-55	365	1622	355	265	225	200	150	6/150	8-Φ18
150WQ200-40-45	350	1453	236	265	225	200	150	6/150	8-Φ18
150WQ200-60-75	435	1609	258	265	225	200	150	6/150	8-Φ18
150WQ200-70-90	435	1684	258	265	225	200	150	6/150	8-Φ18
200WQ300-7-11	310	1000	280	320	280	254	200	8/200	8-Φ18
200WQ250-11-15	310	1080	280	320	280	254	200	8/200	8-Φ18
200WQ250-15-18.5	323	1298	282	320	280	254	200	8/200	8-Φ18
200WQ350-10-18.5	323	1238	223	320	280	254	200	8/200	8-Φ18
200WQ300-16-22	350	1321	253	320	280	254	200	8/200	8-Φ18
200WQ250-22-30	350	1390	253	320	280	254	200	8/200	8-Φ18
200WQ300-28-37	350	1390	253	320	280	254	200	8/200	8-Φ18
200WQ350-25-37	370	1493	353	320	280	254	200	8/200	8-Φ18
200WQ300-40-55	351	1647	353	320	280	254	200	8/200	8-Φ18
200WQ400-30-55	351	1647	353	320	280	254	200	8/200	8-Φ18
200WQ300-32-45	350	1478	353	320	280	254	200	8/200	8-Φ18
200WQ400-25-45	435	1609	258	320	280	254	200	8/200	8-Φ18
200WQ350-45-75	435	1609	258	320	280	254	200	8/200	8-Φ18
200WQ300-60-90	435	1684	258	320	280	254	200	8/200	8-Φ18
200WQ400-50-90	435	1684	258	320	280	254	200	8/200	8-Φ18
250WQ400-5-11	310	1000	280	320	280	254	250	10/250	8-Φ18
250WQ500-5-15	310	1080	280	320	280	254	250	10/250	8-Φ18
250WQ500-7-18.5	340	1265	230	440	350	319	250	10/250	12-Φ22
250WQ500-9-22	340	1291	230	440	350	319	250	10/250	12-Φ22
250WQ500-12-30	422	1449	376	440	350	319	250	10/150	12-Φ22
250WQ-600-9-30	422	1449	376	440	350	319	250	10/250	12-Φ22
250WQ600-12-37	400	1420	276	440	350	319	250	10/250	12-Φ22
250WQ600-15-45	421	1504	276	440	350	319	250	10/250	12-Φ22
250WQ600-20-55	421	1573	276	440	350	319	250	10/250	12-Φ22
250WQ600-25-75	460	1647	294	440	350	319	250	10/250	12-Φ22

Dimensions-4P~6P

Model	B	H	H1	D	D1	D2	D3	DN (Inch/mm)	n-d
250WQ600-30-90	460	1720	294	440	350	319	250	10/250	12-Φ22
300WQ650-5-18.5	406	1505	429	490	400	363	300	12/300	12-Φ22
300WQ650-7-22	406	1505	429	490	400	363	300	12/300	12-Φ22
300WQ800-7-30	385	1847	243	490	400	363	300	12/300	12-Φ22
300WQ800-9-37	385	1617	443	490	400	363	300	12/300	12-Φ22
300WQ800-12-45	404	1500	243	490	400	363	300	12/300	12-Φ22
300WQ800-15-55	406	1774	443	490	400	363	300	12/300	12-Φ22
300WQ800-20-75	460	1804	428	490	400	363	300	12/300	12-Φ22
300WQ800-25-90	433	1694	243	490	400	363	300	12/300	12-Φ22
350WQ1000-6-37	468	1469	273	530	460	420	350	14/350	16-Φ22
350WQ1200-8-45	496	1554	273	530	460	420	350	14/350	16-Φ22
350WQ1000-10-55	468	1623	273	530	460	420	350	14/350	16-Φ22
350WQ1000-15-75	494	1685	273	530	460	420	350	14/350	16-Φ22
350WQ1000-18-90	494	1752	273	530	460	420	350	14/350	16-Φ22
400WQ1300-8-55	494	1714	309	590	515	463	400	16/400	16-Φ22
400WQ1300-13-75	522	1911	488	590	515	463	400	16/400	16-Φ22
400WQ1300-16-90	522	1801	302	590	515	463	400	16/400	16-Φ22
350WQ1100-6-37	502	1769	273	505	460	423	350	14/350	16-Φ22
400WQ1300-5-37	516	1529	298	565	515	475	400	16/400	16-Φ26
350WQ1300-8-45	514	1584	268	505	460	423	350	14/350	16-Φ22
400WQ1700-6-45	513	1614	298	565	515	475	400	16/400	16-Φ26
400WQ1500-8-55	513	1683	298	565	515	475	400	16/400	16-Φ26
500WQ2200-5-55	687	1796	355	670	620	580	500	20/500	20-Φ26
350WQ1500-12-75	521	1726	302	505	460	423	350	14/350	16-Φ22
400WQ1700-10-75	575	1824	303	565	515	475	400	16/400	16-Φ26
500WQ2000-8-75	687	1976	355	670	620	580	500	20/500	20-Φ26
350WQ1200-18-90	550	1924	273	505	460	423	350	14/350	16-Φ22
400WQ1500-15-90	578	2134	483	565	515	475	400	16/400	16-Φ26
500WQ2000-10-90	687	2000	355	670	620	580	500	20/500	20-Φ26

WQK

Cutting Submersible Sewage Pumps



Sewage water



Agricultural



Civil use



Industrial use



Product Overview

WQK Cutting Submersible Sewage Pumps consists of motor, water pump and seal. Motor is located at the upper part of the electric pump, which is a three-phase asynchronous motor. Alloy double-end mechanical seal is used between the water pump and the motor, and "O" type oil-resistant rubber seal is used as static seal at the fixed stop seal.

Main Application

WQK Cutting Submersible Sewage Pumps is mainly used for engineering sewage and domestic sewage.

Such as:

- Used in construction sites, engineering foundation construction, municipal facilities and waterworks.
- Underground sewage discharge in basements, civil air defense pits and subways of various high-rise buildings.
- Sewage treatment and circulating water transportation in small and medium-sized enterprises.
- Slag slurry pumping in food, paper making, brewing, iron and steel, nonferrous metals, leather making, textile, pharmaceutical, cement plants and other factories and mines.
- Chicken farms, pig farms, various breeding industries, fish ponds are used for pumping water, clearing ponds and oxygenation. In septic tanks are used for pumping human, animal excrement and urine.

Operating Conditions

This pump can work continuously and normally under the following conditions:

- Medium of the electric pump is normal temperature slurry (less than 40°C)
- PH value is between 4-10, and volume of the solid matter of the medium is below 2%; Sewage pumps are used to drain and irrigate thicker slurry
- After use, be sure to run it in clean water for a few minutes, clean it then store it
- Over current and leakage protectors should be installed for specifications above 4KW
- The diving depth should not exceed 5m

Model Implication

50 WQK 7 - 15 - 1.1

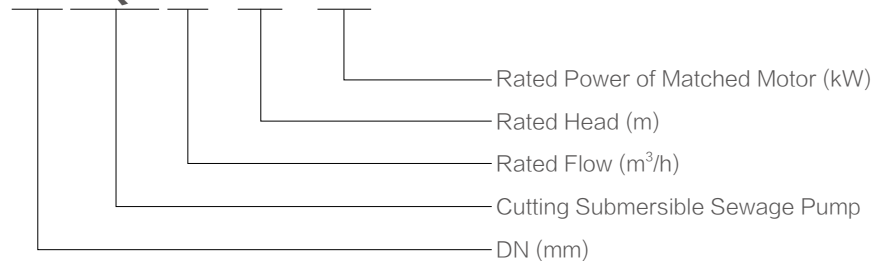

Hydraulic Performance Curves

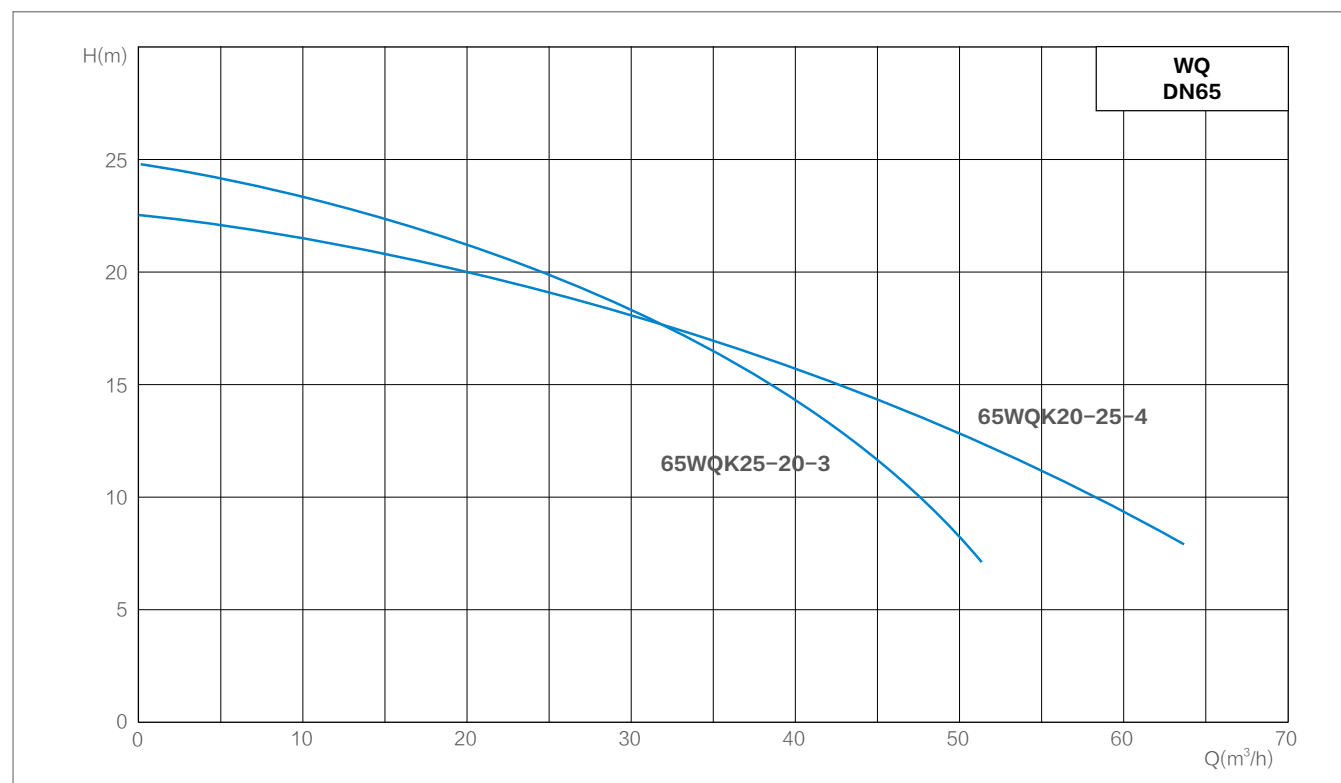
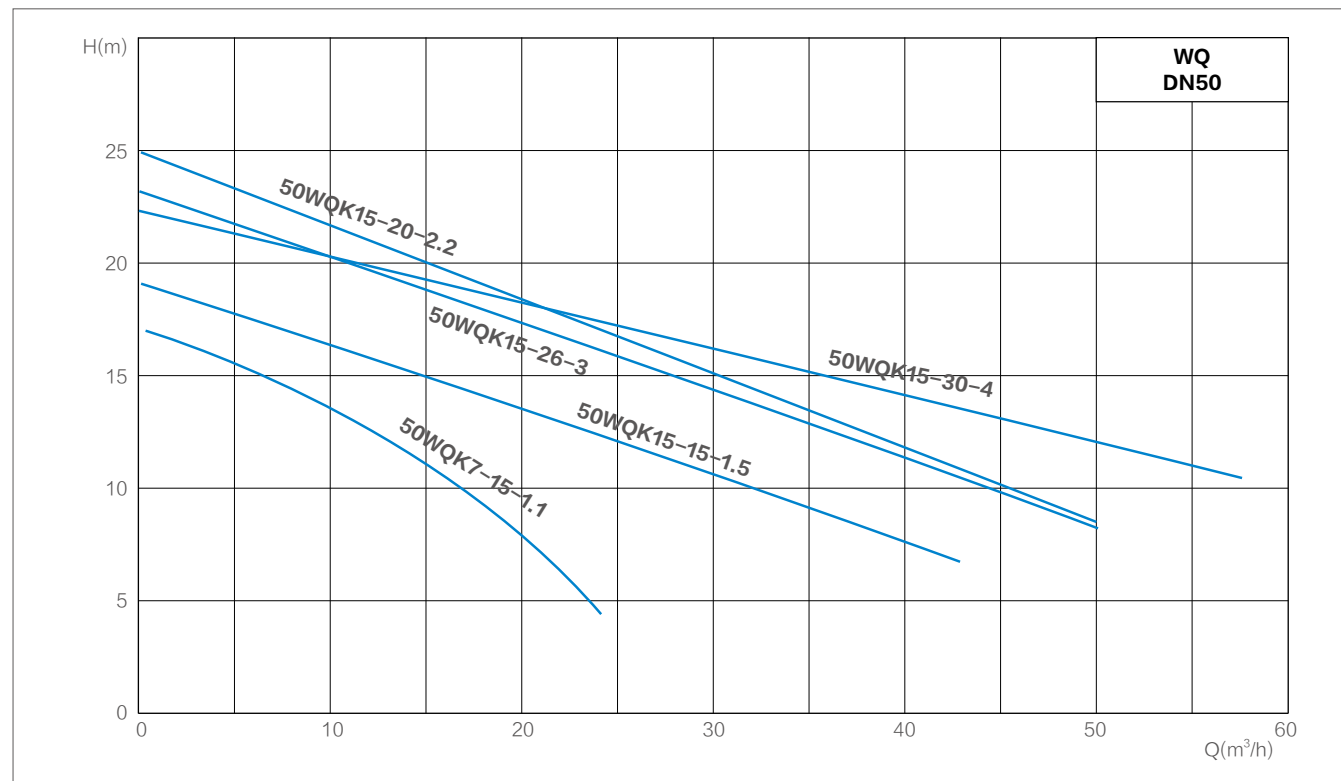

Hydraulic Performance Curves

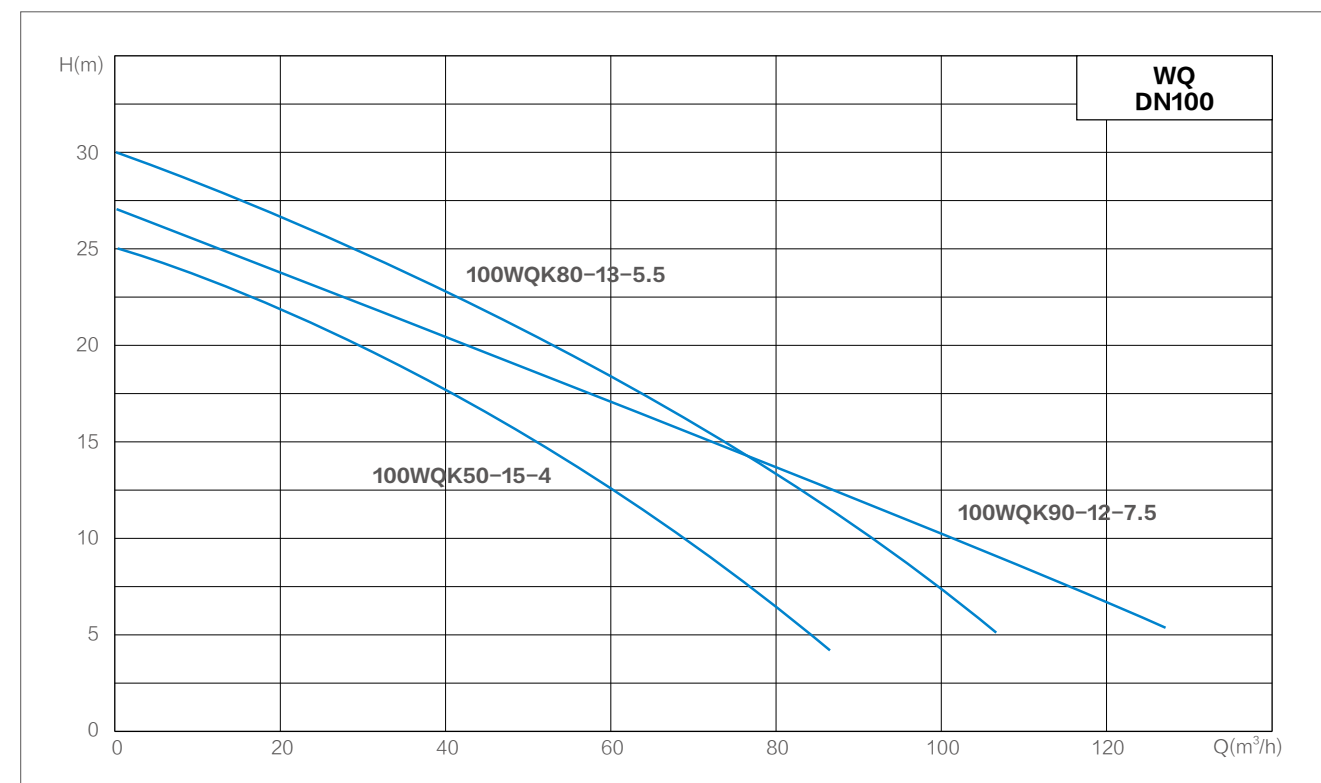
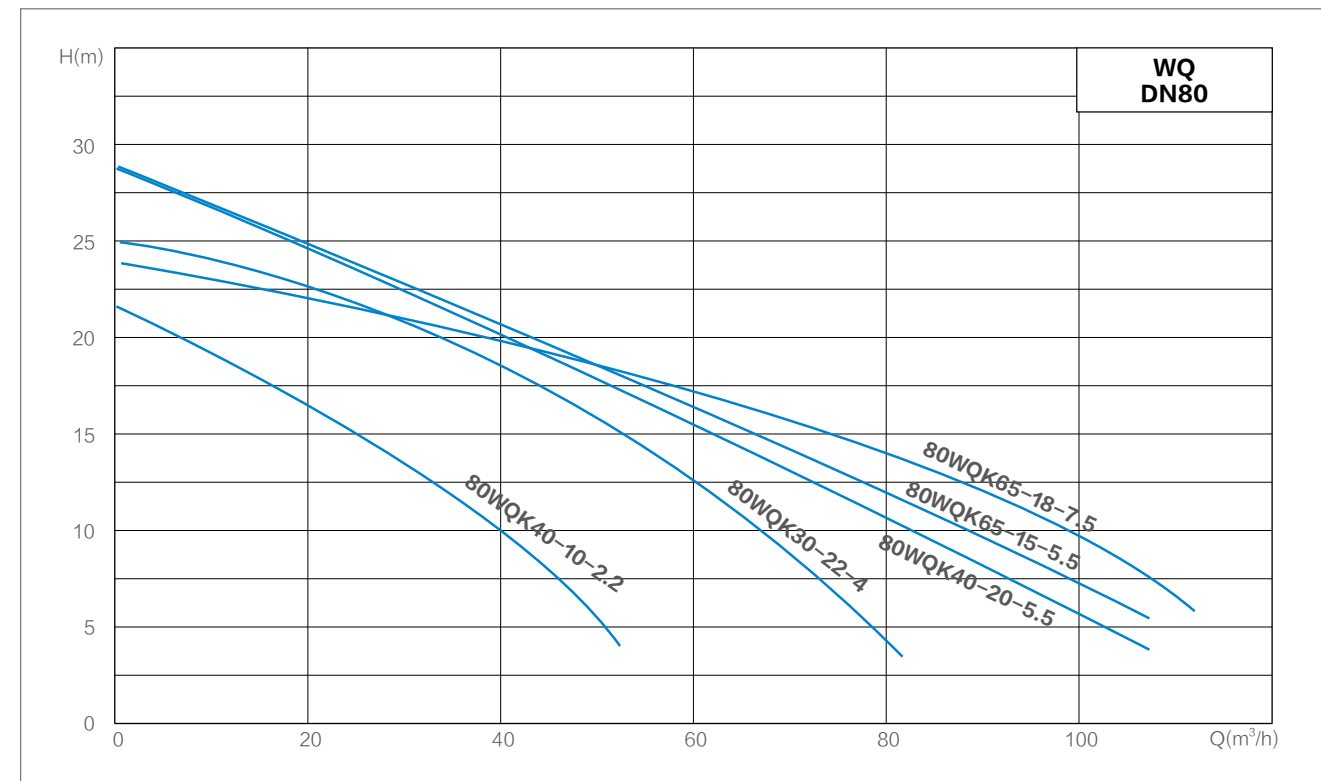

Technical Parameter

Model	Power	Voltage	Rated Flow	Rated Head	Speed	DN
	kW	V	m ³ /h	m	r/min	mm
50WQK7-15-1.1	1.1	380	7	15	2860	50
50WQK15-15-1.5	1.5	380	15	15	2860	50
50WQK15-20-2.2	2.2	380	15	20	2860	50
50WQK15-26-3	3.0	380	15	26	2860	50
50WQK15-30-4	4.0	380	15	30	2860	50
65WQK18-15-1.5	1.5	380	18	15	2860	65
65WQK25-18-2.2	2.2	380	25	18	2860	65
65WQK25-20-3	3.0	380	25	20	2860	65
65WQK20-25-4	4.0	380	20	25	2860	65
80WQK40-10-2.2	2.2	380	40	10	2860	80
80WQK40-15-3	3.0	380	40	15	2860	80
80WQK30-22-4	4.0	380	30	22	2860	80
80WQK65-15-5.5	5.5	380	65	15	2860	80
80WQK40-20-5.5	5.5	380	40	20	2860	80
80WQK65-18-7.5	7.5	380	65	18	2860	80
100WQK50-15-4	4.0	380	50	15	2860	100
100WQK80-13-5.5	5.5	380	80	13	2860	100
100WQK90-12-7.5	7.5	380	90	12	2860	100

Dimensions

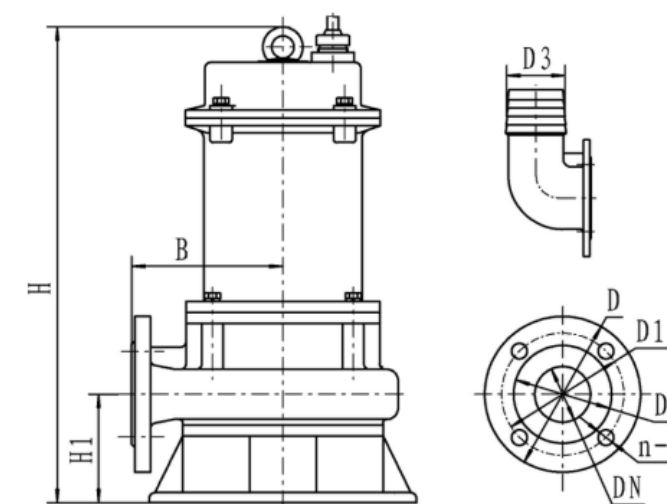

Model	B	H	H1	D	D1	D2	D3	DN (mm)	n-d
50WQK7-15-1.1	132	510	98	140	110	92	50	50	4-Φ14
50WQK15-15-1.5	168	560	121	140	110	92	50	50	4-Φ14
50WQK15-20-2.2	170	570	121	140	110	92	50	50	4-Φ14
50WQK15-26-3	170	590	121	140	110	92	50	50	4-Φ14
50WQK15-30-4	178	610	129	140	110	92	50	50	4-Φ14
65WQK18-15-1.5	170	560	121	160	130	110	64	65	4-Φ14
65WQK25-18-2.2	170	570	121	160	130	110	64	65	4-Φ14
65WQK25-20-3	170	590	121	160	130	110	64	65	4-Φ14
65WQK20-25-4	178	610	129	160	130	110	64	65	4-Φ14
80WQK40-10-2.2	170	570	121	160	150	130	64	80	4-Φ18
80WQK40-15-3	170	590	121	190	150	130	76	80	4-Φ18
80WQK30-22-4	178	610	129	190	150	130	76	80	4-Φ18
80WQK65-15-5.5	190	710	152	190	150	130	76	80	4-Φ18
80WQK40-20-5.5	190	710	152	190	150	130	76	80	4-Φ18
80WQK65-18-7.5	192	750	156	190	150	130	76	80	4-Φ18
100WQK50-15-4	178	610	129	210	170	148	100	100	4-Φ18
100WQK80-13-5.5	190	710	152	210	170	148	100	100	4-Φ18
100WQK90-12-7.5	190	750	156	210	170	148	100	100	4-Φ18

QY

Oil Immersed Submersible Electric Pump



Agricultural



Civil use



Industrial use



Operating Conditions

The electric pump can operate continuously and normally under the following usage conditions

- The working medium is non corrosive clean water, with a volume ratio of sand content not exceeding 0.10% and a particle size not exceeding 0.20mm.
- The medium temperature shall not exceed 40 °C , and the pH value of the medium shall be between 6.5 and 8.5.
- Submersible pumps should be used within the range of use near the rated head and completely submerged in water. The diving depth should not exceed 3 meters, and the maximum depth should not exceed 5 meters.
- The submersible pump should be at least 0.5m away from the bottom of the water, but should not be trapped in mud, otherwise it may cause an explosion.
- The power frequency is three-phase 50Hz, the voltage is 380V, and the voltage fluctuation range is 0.9-1.1 times the rated value.

Model Implication

QY 15 - 26 - 2.2

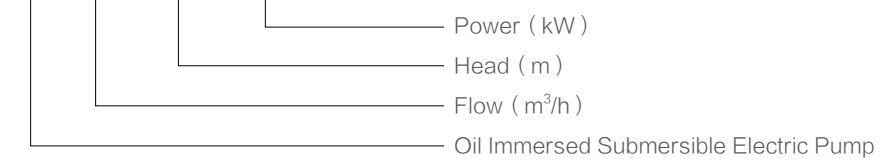

Hydraulic Performance Curves

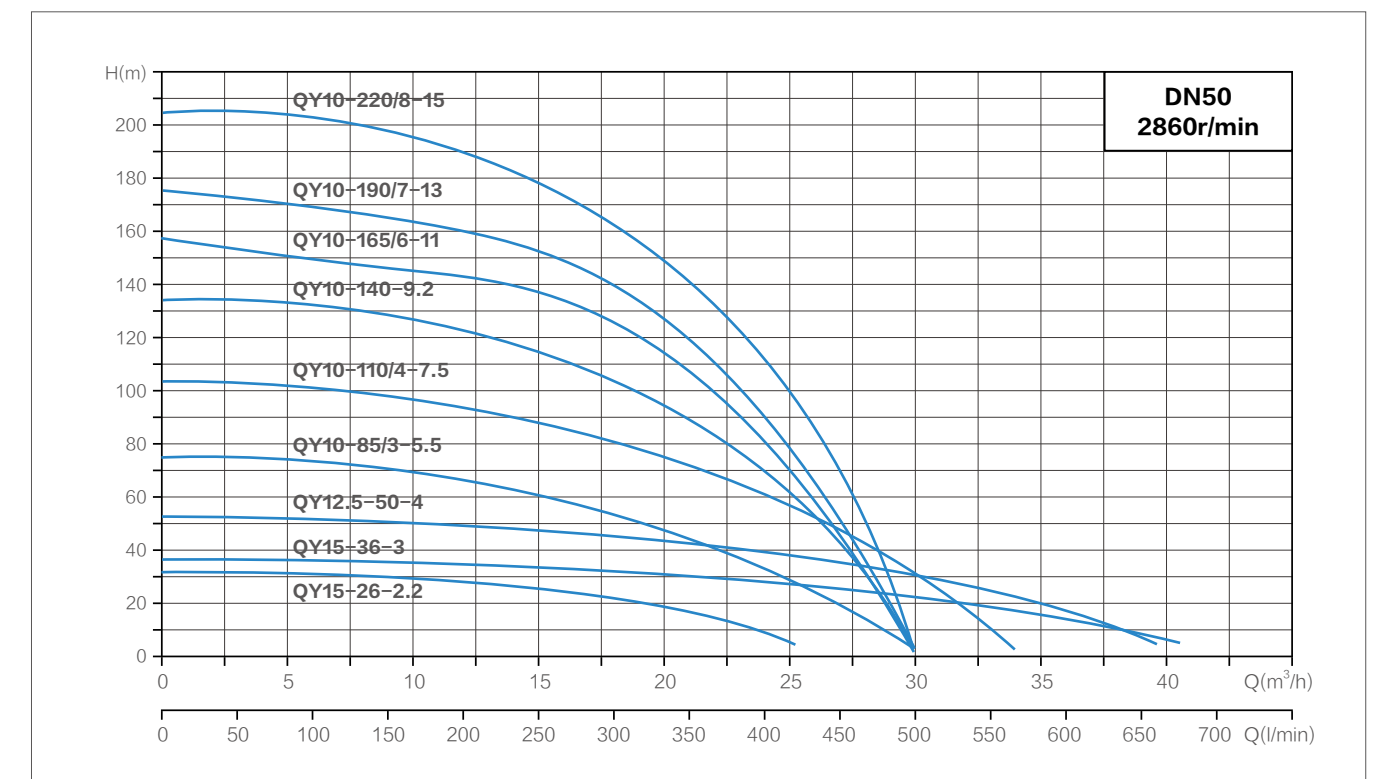

Hydraulic Performance Curves

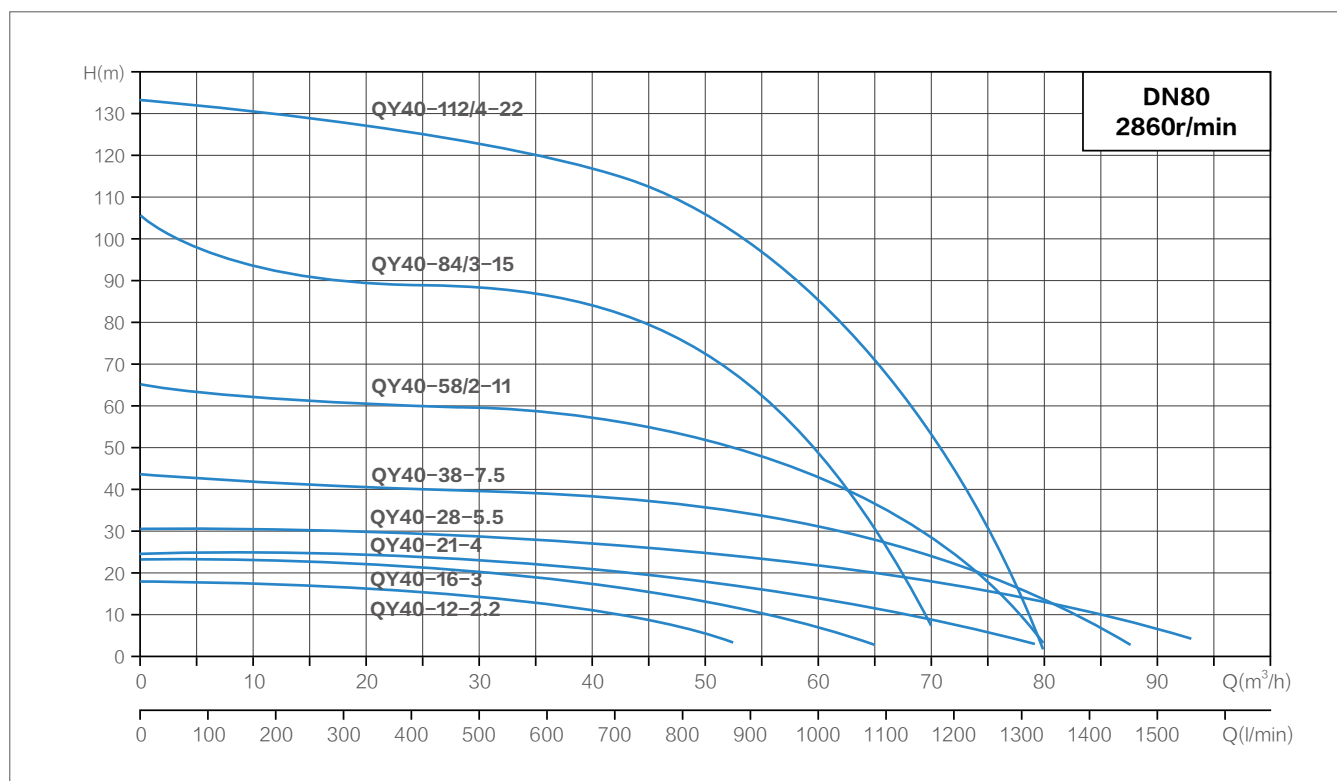
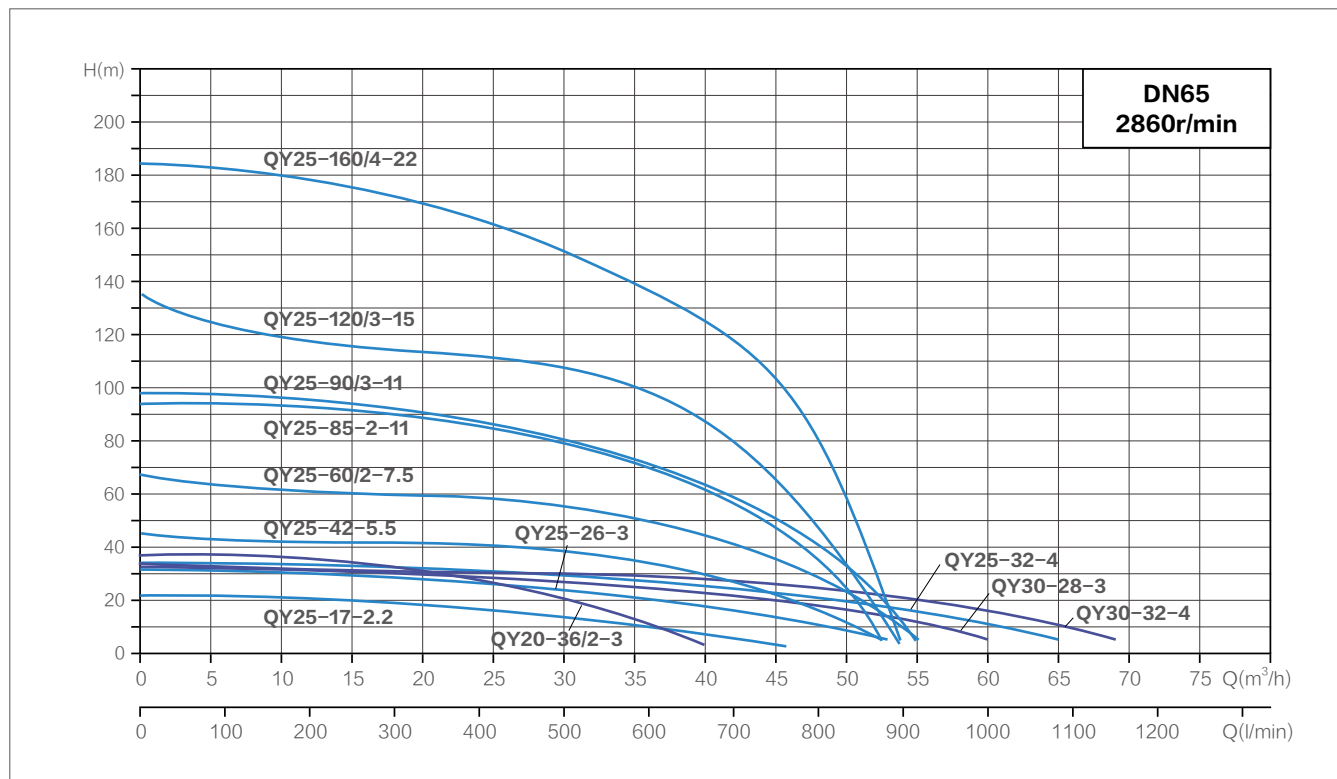

Hydraulic Performance Curves

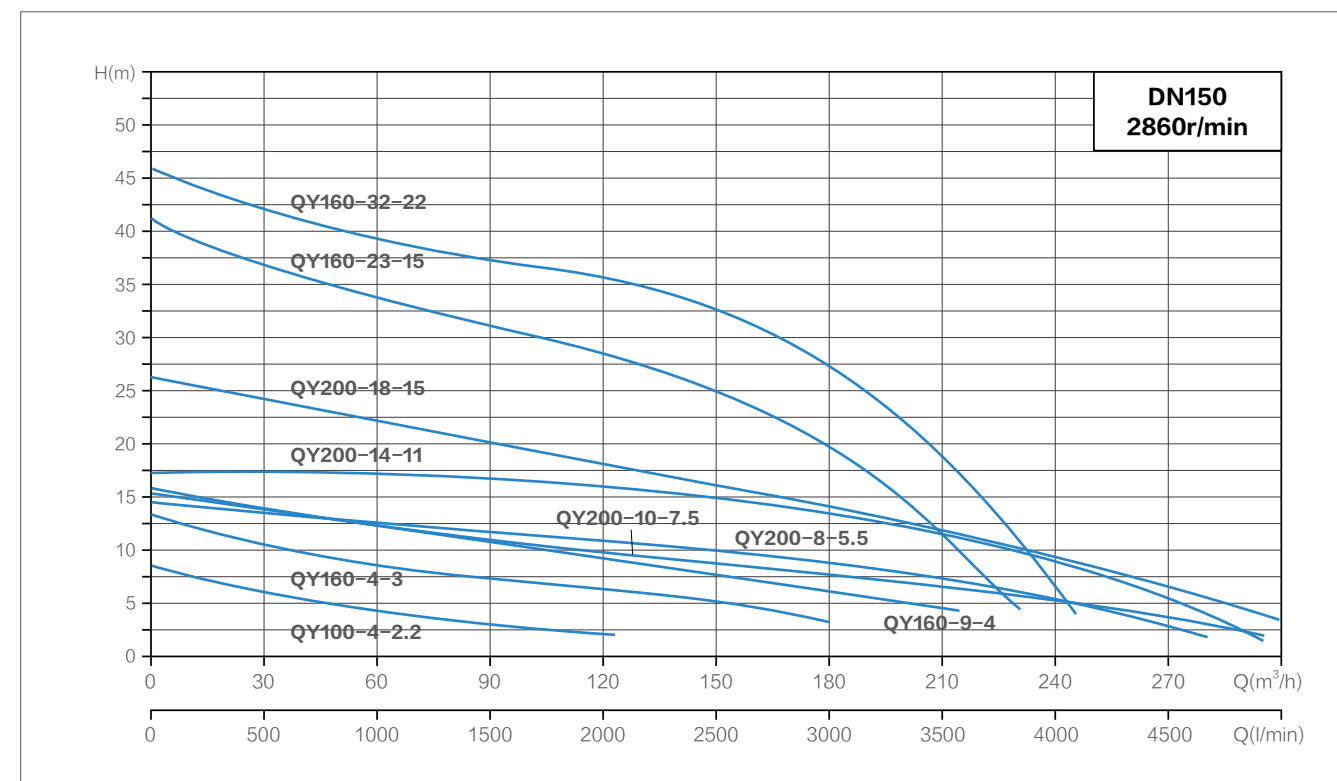
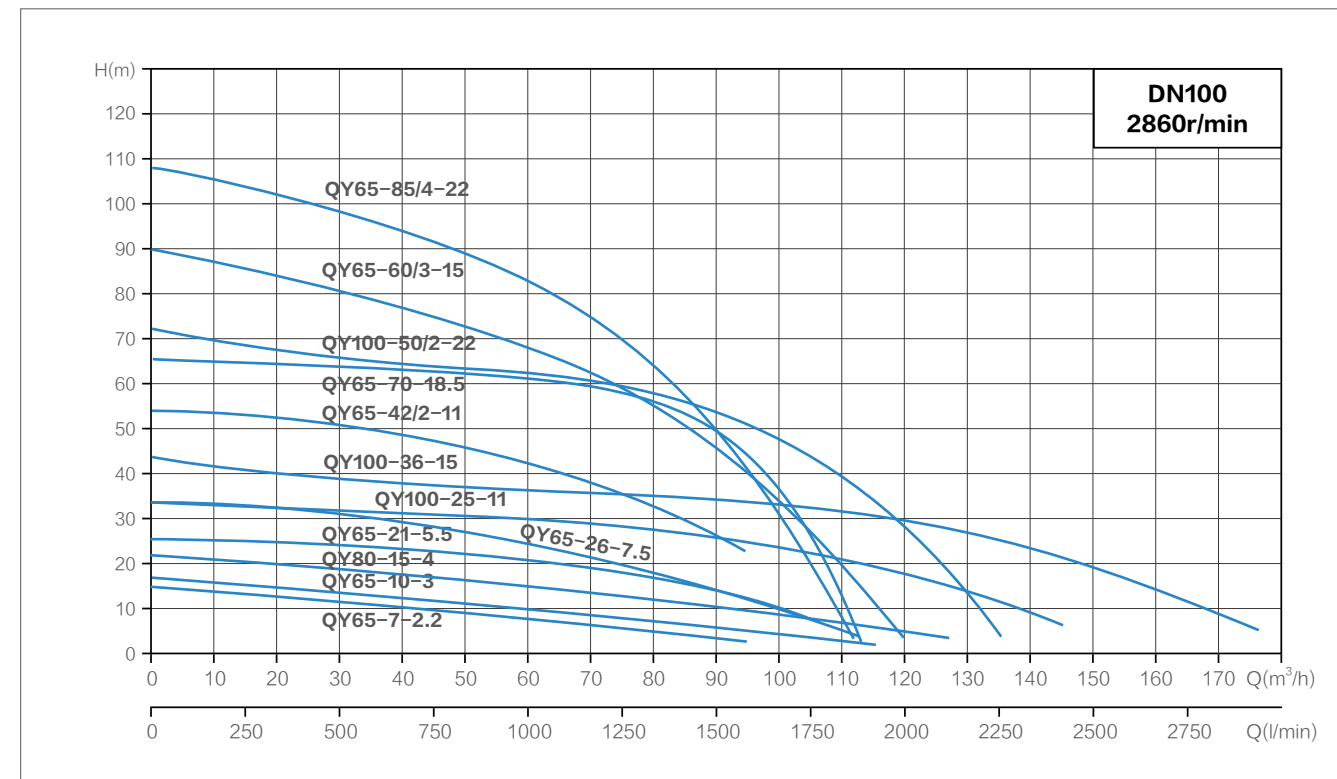

Hydraulic Performance Curves

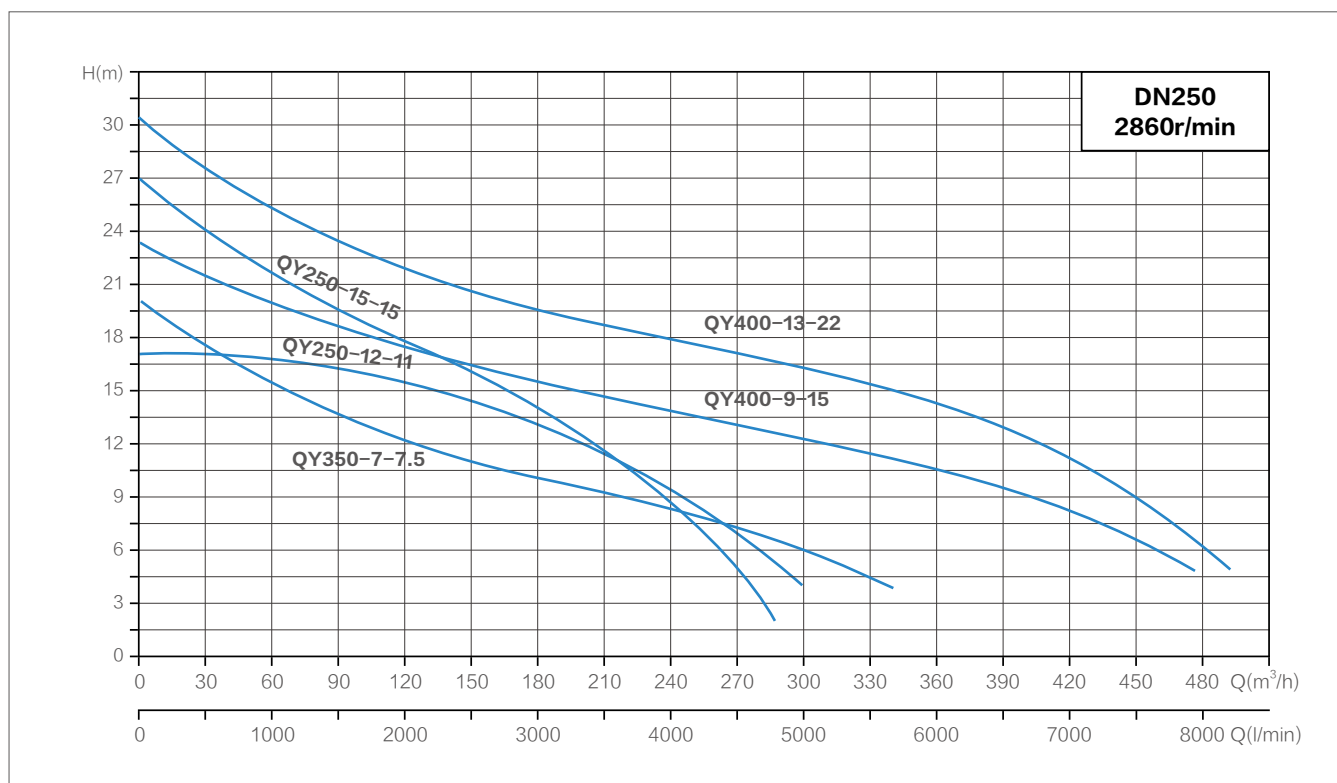
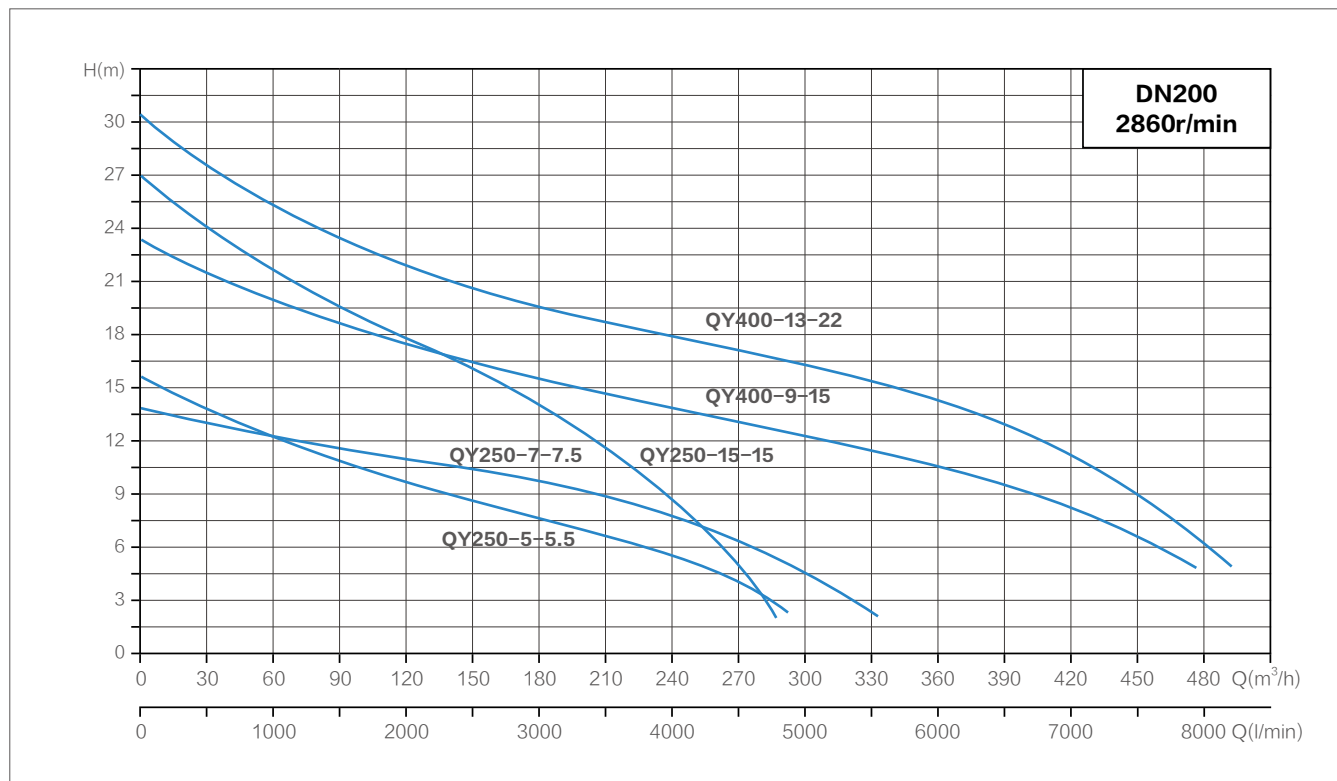

Technical Parameter

Model	Rated Flow	Rated Head	Rated Power	Rated Voltage	Rated Current	Speed	Eff.	Inner diameter of piping	Head usage
	m³/h	m	kW	V	A	r/min	%	mm	
QY15-26-2.2	15	26	2.2	380	5.1	2860	40.8	51	Total pump head
QY15-36-3	15	36	3	380	6.7	2860	39.4	51	
QY12.5-50-4	12.5	46	4	380	8.9	2860	41.8	51	
QY10-85/3-5.5	10	70	5.5	380	10.8	2860	38.1	51	
QY10-110/4-7.5	10	100	7.5	380	14.7	2860	38.2	51	
QY10-140/5-9.2	10	130	9.2	380	18.2	2860	45.2	51	
QY10-165/6-11	10	150	11	380	22.1	2860	31.2	51	
QY10-190/7-13	10	170	13	380	25.9	2860	30.7	51	
QY10-220/8-15	10	200	15	380	29.6	2860	37.6	51	
QY25-17-2.2	25	17	2.2	380	5.1	2860	47.5	64	
QY25-26-3	25	26	3	380	6.7	2860	47	64	
QY30-28-3	30	26	3	380	6.7	2860	48	64	
QY20-36/2-3	20	31	3	380	6.7	2860	47.9	64	
QY25-32-4	25	32	4	380	8.9	2860	46.3	64	
QY30-32-4	30	30	4	380	8.9	2860	59.4	64	
QY25-42-5.5	25	42	5.5	380	10.8	2860	44.3	64	
QY25-60/2-7.5	25	60	7.5	380	14.7	2860	47.9	64	
QY25-85/2-11	25	85	11	380	22.1	2860	46	64	
QY25-90/3-11	25	90	11	380	22.1	2860	38.9	64	
QY25-120/3-15	25	120	15	380	29.6	2860	44	64	
QY25-160/4-22	25	160	22	380	43.5	2860	45	64	
QY40-12-2.2	40	12	2.2	380	5.1	2860	49.6	76	
QY40-16-3	40	16	3	380	6.7	2860	51	76	
QY40-21-4	40	21	4	380	8.9	2860	51.7	76	
QY40-28-5.5	50	25	5.5	380	10.8	2860	51.3	76	
QY40-38-7.5	50	35	7.5	380	14.7	2860	50.1	76	
QY40-58/2-11	40	58	11	380	22.1	2860	43.4	76	
QY40-84/3-15	40	87	15	380	29.6	2860	44.4	76	
QY40-112/4-22	40	120	22	380	43.5	2860	45.4	76	
QY65-7-2.2	65	7	2.2	380	5.1	2860	47.7	102	

Technical Parameter

Model	Rated Flow	Rated Head	Rated Power	Rated Voltage	Rated Current	Speed	Eff.	Inner diameter of piping	Head usage
	m ³ /h	m	kW	V	A	r/min	%	mm	
QY65-10-3	65	10	3	380	6.7	2860	51.5	102	Total pump head
QY85-15-4	65	15	4	380	8.9	2860	53.2	102	
QY65-21-5.5	65	21	5.5	380	10.8	2860	53.9	102	
QY65-26-7.5	65	23	7.5	380	14.7	2860	54.6	102	
QY65-42/2-11	65	40	11	380	22.1	2860	54.5	102	
QY100-25-11	100	25	11	380	22.1	2860	56.5	102	
QY65-60/3-15	65	60	15	380	29.6	2860	49.6	102	
QY100-36-15	100	33	15	380	29.6	2860	53.6	102	
QY65-70-18.5	65	60	18.5	380	36.8	2860	49.8	102	
QY65-85/4-22	65	80	22	380	43.5	2860	45.1	102	
QY100-50/2-22	100	46	22	380	43.5	2860	55	102	
QY100-4-2.2	100	5	2.2	380	5.1	2860	48.5	152	
QY160-4-3	150	5	3	380	6.7	2860	50.8	152	
QY100-9-4	100	9	4	380	8.9	2860	51.5	152	
QY200-8-5.5	200	6.5	5.5	380	10.8	2860	52.6	152	
QY200-10-7.5	200	9	7.5	380	14.7	2860	52.8	152	
QY200-14-11	200	13	11	380	22.1	2860	54.5	152	
QY160-23-15	160	23	15	380	29.6	2860	55.2	152	
QY200-18-15	200	16	15	380	29.6	2860	55	152	
QY160-32-22	160	32	22	380	43.5	2860	56.5	152	
QY250-5-5.5	250	5	5.5	380	10.8	2860	52.6	203	
QY250-7-7.5	260	8	7.5	380	14.7	2860	52.8	203	
QY250-15-15	250	15	15	380	29.6	2860	49.1	203	
QY400-9-15	400	9	15	380	29.6	2860	52	203	
QY400-13-22	400	13	22	380	43.5	2860	42	203	
QY350-5-7.5	350	5	7.5	380	14.7	2860	50	253	
QY250-12-11	220	12	11	380	22.1	2860	54	253	
QY450-6-11	450	6	11	380	22.1	2860	54	253	
QY250-15-15	250	15	15	380	29.6	2860	39.1	253	
QY400-9-15	400	9	15	380	29.6	2860	52	253	
QY400-13-22	400	13	22	380	43.5	2860	42	253	

YSG/YSW

High Quality Dry Grinding Resistant Pipeline Pump



Sewage water



Agricultural



Civil use



Industrial use



Main Application

YSG/YSW High Quality Dry Grinding Resistant Pipeline Pump is a multifunctional product with a wide range of applications, capable of conveying various media including water or industrial liquids, suitable for different temperature, flow rate, and pressure ranges. Its typical applications mainly include the following aspects:

- Thin, clean, non corrosive, non flammable and explosive materials without solid particles or fibers;
- Situations with substances such as softened water, purified water, domestic water supply, clean oil, etc;
- Suitable for industrial and urban water supply and drainage, high-rise pressurized water supply, garden sprinkler irrigation, fire pressurization, long-distance transportation, HVAC refrigeration, and other cold and warm water circulation pressurization and equipment matching;
- Applicable to energy, metallurgy, chemical, textile, papermaking, as well as boiler hot water pressurization transmission and urban heating system circulation in hotels and restaurants.

Used Conditions

- Maximum pressure of the pump system is 1.6Mpa, i.e. pump inlet pressure + pump head \leq 1.6Mpa. (Please specify the system working pressure when ordering. So that the over-flow part and coupling part of the pump are made of cast iron.)
- Applicable medium: volume content of solid insoluble matter doesn't exceed 0.1% of the unit volume, and the particle size is not larger than 0.2mm. (If the medium has fine particles, the wear-resistant mechanical seal must be used, please specify when ordering).
- Ambient temperature not more than 40°C , relative temperature not more than 95°C , altitude not more than 1000m.

Model Implication

YSW 50 - 160 - 3



Hydraulic Performance Curves

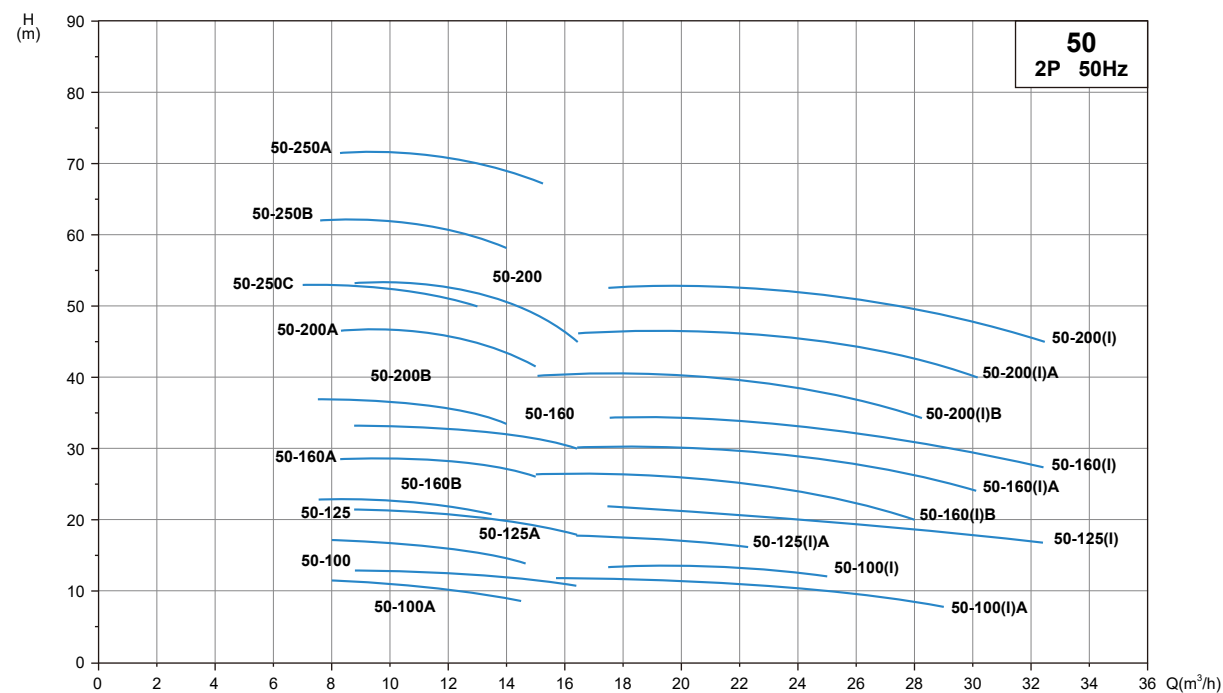
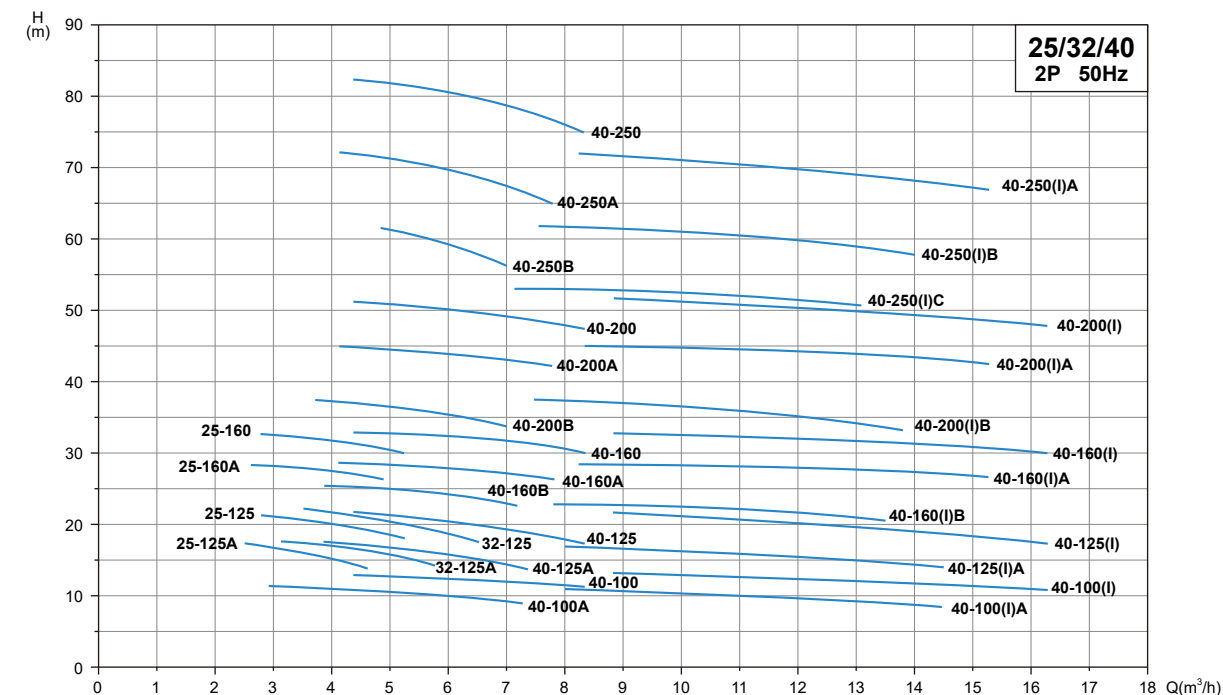

Hydraulic Performance Curves

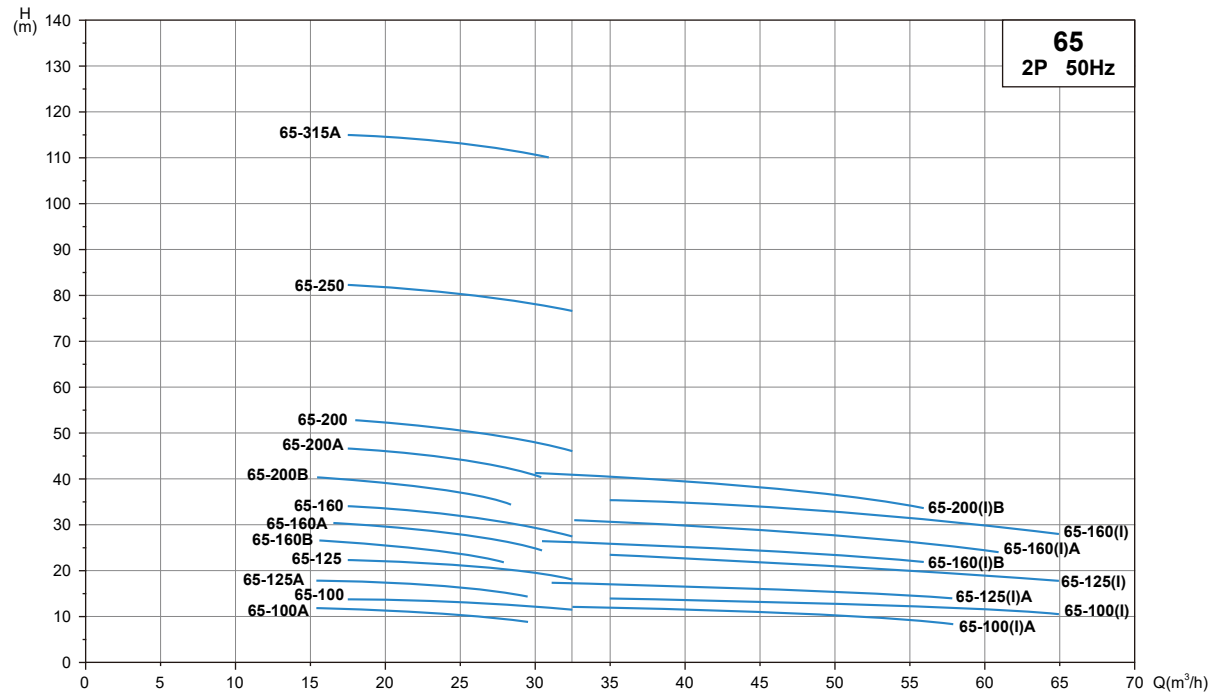

Hydraulic Performance Curves

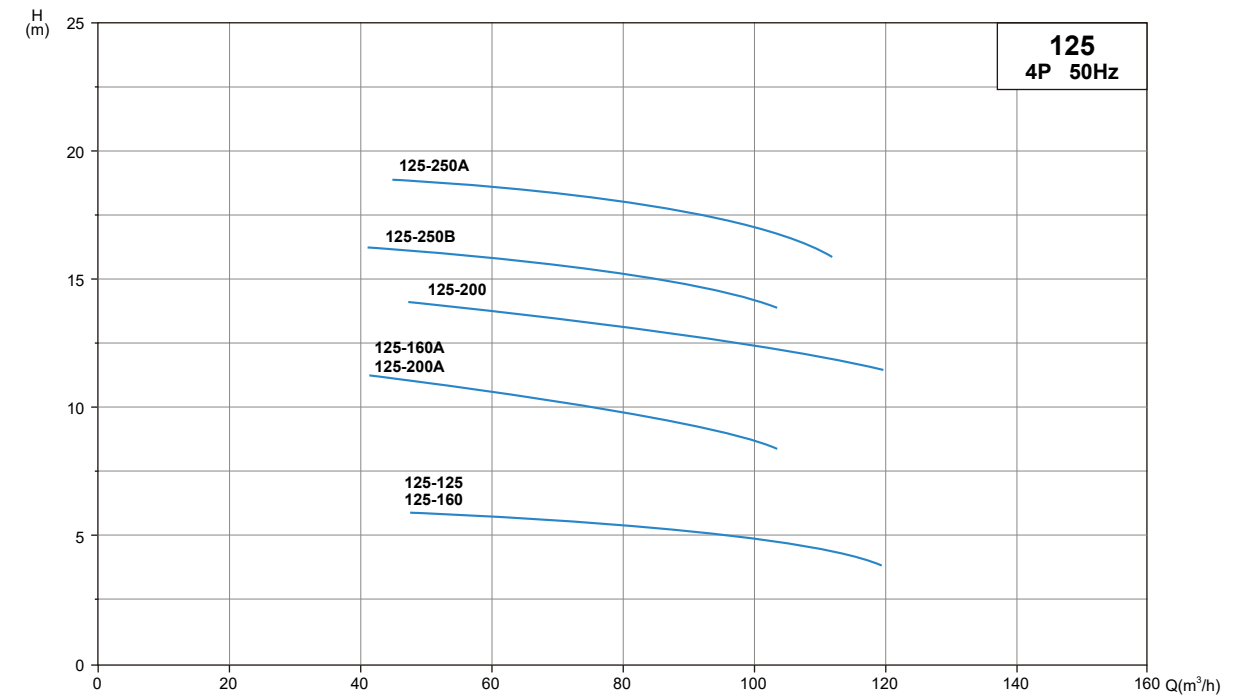
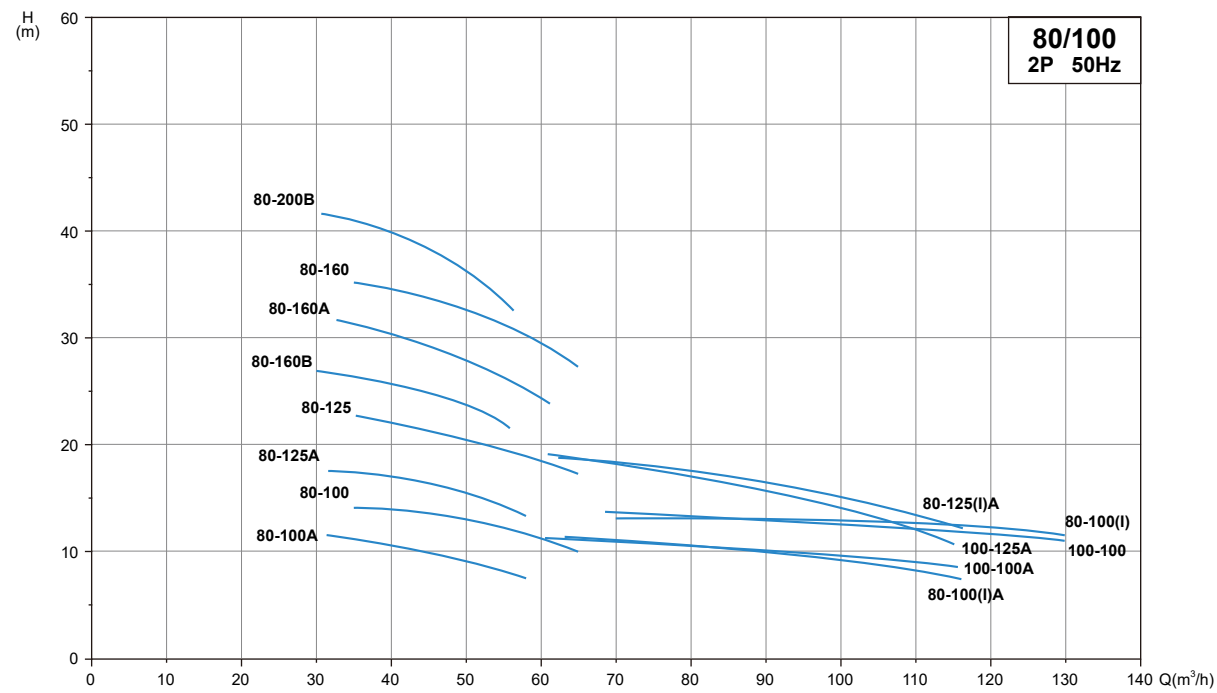
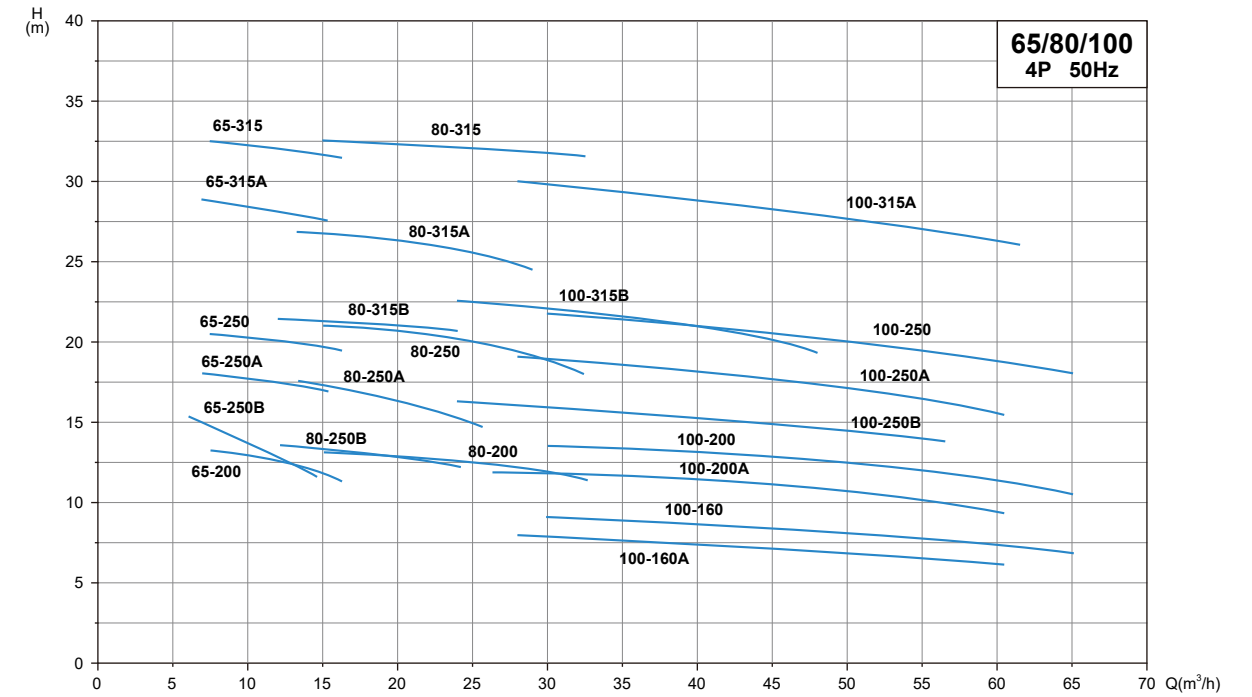

Technical Parameter

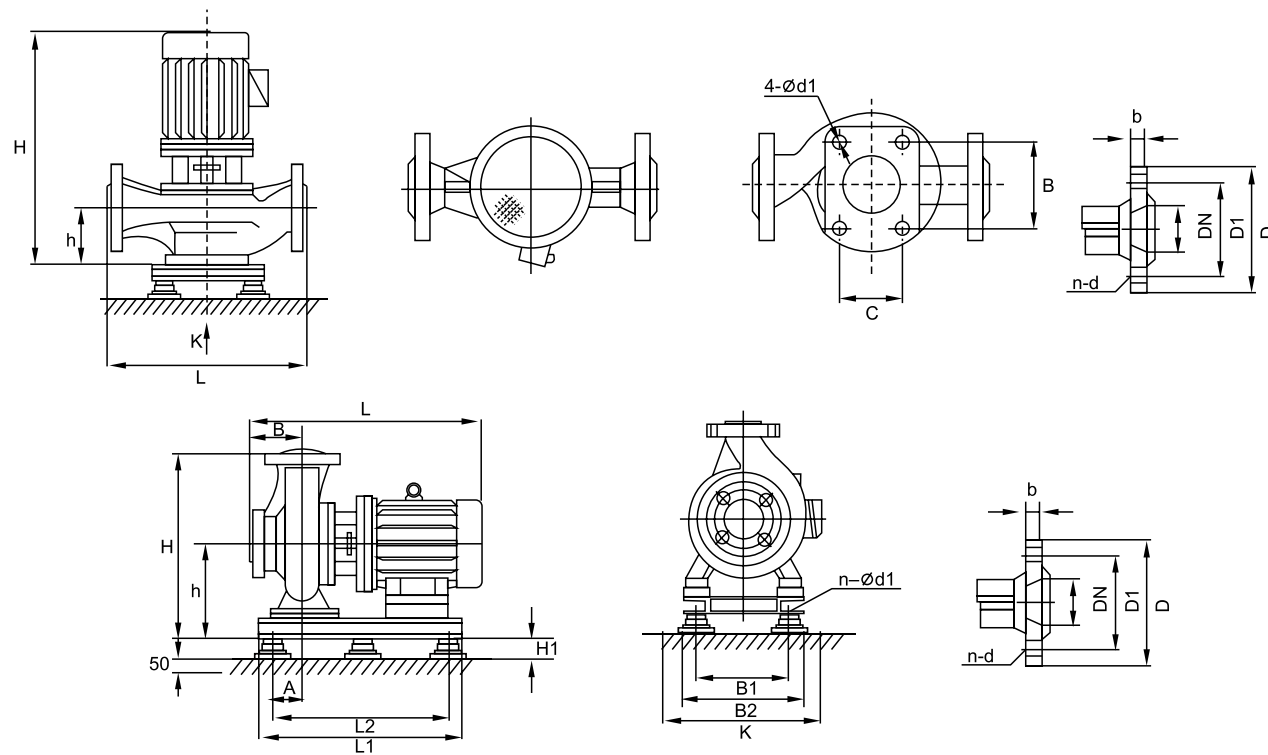

Model	Flow Q		Head (m)	Eta (%)	Speed (r/min)	Power (kW)	NPSH (m)	Vertical Type Installation Size					Horizontal Type Installation Size					Flange Size			Vibration Isolators Spec	H1		
	m³/h	L/s						H	L	h	B	C	H	h	a	L1	L2	B1	D	D1			n-d	
25-125	2.8	0.78	20.6	28	2900	0.75	2.3	430	265	75	80	50	320	180	90	405	445	210	260	Φ115	Φ85	4-Φ14	SD41-0.5	20
	4	1.11	20	36																				
	5.2	1.44	18	35																				
25-125A	2.5	0.69	17	27	2900	0.75	2.3	430	265	75	80	50	320	180	90	405	445	210	260	Φ115	Φ85	4-Φ14	SD41-0.5	20
	3.6	1	16	35																				
	4.6	1.28	14.4	34																				
25-160	2.8	0.78	33	24	2900	1.5	2.3	455	300	75	115	70	320	180	90	440	470	250	300	Φ115	Φ85	4-Φ14	SD41-0.5	20
	4	1.11	32	32																				
	5.2	1.44	30	33																				
25-160A	2.6	0.72	29	22	2900	1.1	2.3	440	300	75	115	70	320	180	90	440	455	250	300	Φ115	Φ85	4-Φ14	SD41-0.5	20
	3.7	1.03	28	31																				
	4.9	1.36	26	32																				
32-125	3.5	0.97	22	40	2900	0.75	2.3	445	270	75	100	60	320	180	90	440	455	250	310	Φ140	Φ100	4-Φ18	SD41-0.5	20
	5	1.39	20	44																				
	6.5	1.8	18	42																				
32-125A	3.1	0.86	17.6	38	2900	0.75	2.3	445	270	75	100	60	320	180	90	440	455	250	310	Φ140	Φ100	4-Φ18	SD41-0.5	20
	4.5	1.25	16	42																				
	5.8	1.61	14.4	40																				

Technical Parameter

Model	Flow Q		Head (m)	Eta (%)	Speed (r/min)	Power (kW)	NPSH (m)	Vertical Type Installation Size					Horizontal Type Installation Size					Flange Size			Vibration Isolators Spec	H1		
	m³/h	L/s						H	L	h	B	C	H	h	a	L1	L2	B1	D	D1			n-d	
40-100	4.4	1.22	13.2	48	2900	0.75	2.3	410	290	80	115	60	260	145	95	405	460	260	125	Φ150	Φ110	4-Φ18	SD41-0.5	20
	6.3	1.75	12.5	54																				
	8.3	2.31	11.3	53																				
40-100A	3.9	1.08	10.6	45	2900	0.75	2.3	410	290	80	115	60	260	145	95	405	460	260	125	Φ150	Φ110	4-Φ18	SD41-0.5	20
	5.6	1.56	10	52																				
	7.4	2.06	9	50																				
40-125	4.4	1.22	21	41	2900	1.1	2.3	410	290	80	115	60	305	165	80	405	445	210	260	Φ150	Φ110	4-Φ18	SD41-0.5	20
	6.3	1.75	20	46																				
	8.3	2.31	18	43																				
40-125A	3.9	1.08	17.6	40	2900	0.75	2.3	410	290	80	115	60	305	165	80	405	445	210	260	Φ150	Φ110	4-Φ18	SD41-0.5	20
	5.6	1.56	16	45																				
	7.4	2.06	14.4	41																				
40-160	4.4	1.22	33	35	2900	2.2	2.3	445	320	80	115	70	350	190	85	410	489	257	300	Φ150	Φ110	4-Φ18	SD41-0.5	20
	6.3	1.75	32	40																				
	8.3	2.31	30	40																				
40-160A	4.1	1.44	29	34	2900	1.5	2.3	420	320	80	115	70	350	190	85	410	465	257	300	Φ150	Φ110	4-Φ18	SD41-0.5	20
	5.9	1.64	28	39																				
	7.8	2.17	26.3	39																				
40-160B	3.8	1.06	25.5	34	2900	1.1	2.3	405	320	80	115	70	370	190	85	410	450	257	300	Φ150	Φ110	4-Φ18	SD41-0.5	20
	5.5	1.53	24	38																				
	7.2	2	22.5	37																				
40-200	4.4	1.22	51	26	2900	4	2.3	525	345	85	135	80	405	230	85	490	560	300	350	Φ150	Φ110	4-Φ18	SD41-0.5	20
	6.3	1.75	50	33																				
	8.3	2.31	48	32																				
40-200A	4.1	1.14	45	26	2900	3	2.3	495	345	85	135	80	405	230	85	490	530	300	350	Φ150	Φ110	4-Φ18	SD41-0.5	20
	5.9	1.64	44	31																				
	7.8	2.17	42	30																				
40-200B	3.7	1.08	38	23	2900	2.2	2.3	470	345	85	135	80	395	220	85	455	505	280	310	Φ150	Φ110	4-Φ18	SD41-0.5	20
	5.3	1.47	36	29																				
	7	1.94	34.5	24																				
40-250	4.4	1.22	82	24	2900	7.5	2.3	580	400	100	130	80	455	255	80	540	625	340	380	Φ150	Φ110	4-Φ18	SD41-0.5	20
	6.3	1.75	80	28																				
	8.3	2.31	75	28																				
40-250A	4.1	1.14	72	24	2900	5.5	2.3	580	400	100	130	80	455	255	80	540	625	340	380	Φ150	Φ110	4-Φ18	SD41-0.5	20
	5.9	1.64	70	28																				
	7.8	2.17	65	27																				
40-250B	3.8	1.06	61.5	23	2900	4	2.3	535	400	100	130	80	455	255	80	540	570	340	380	Φ150	Φ110	4-Φ18	SD41-0.5	20
	5.5	1.53	60	27																				
	7	1.94	56	26																				

Technical Parameter

Model	Flow Q		Head (m)	Eta (%)	Speed (r/min)	Power (kW)	NPSH (m)	Vertical Type Installation Size					Horizontal Type Installation Size					Flange Size			Vibration Isolators Spec	H1		
	m³/h	L/s						H	L	h	B	C	H	h	a	L1	L	L2	B1	D			D1	n-d
40-100(I)	8.8	2.44	13.2	55	2900	1.1	2.3	420	300	95	120	70	290	145	80	405	470	210	260	Φ150	Φ110	4-Φ18	SD41-0.5	20
	12.5	3.47	12.5	62				420	300	95	120	70	290	145	80	405	470	210	260	Φ150	Φ110	4-Φ18	SD41-0.5	20
	16.3	4.53	11.3	60				420	300	95	120	70	290	145	80	405	470	210	260	Φ150	Φ110	4-Φ18	SD41-0.5	20
40-100(I)A	8	2.22	10.6	52	2900	0.75	2.3	420	300	95	120	70	290	145	80	405	470	210	260	Φ150	Φ110	4-Φ18	SD41-0.5	20
	11	3.05	10	60				420	300	95	120	70	290	145	80	405	470	210	260	Φ150	Φ110	4-Φ18	SD41-0.5	20
	14.5	4.06	9	56				420	300	95	120	70	290	145	80	405	470	210	260	Φ150	Φ110	4-Φ18	SD41-0.5	20
40-125(I)	8.8	2.44	21.2	49	2900	1.5	2.3	430	305	90	120	70	320	170	90	440	480	250	300	Φ150	Φ110	4-Φ18	SD41-0.5	20
	12.6	3.47	20	58				430	305	90	120	70	320	170	90	440	480	250	300	Φ150	Φ110	4-Φ18	SD41-0.5	20
	16.3	4.53	17.8	57				430	305	90	120	70	320	170	90	440	480	250	300	Φ150	Φ110	4-Φ18	SD41-0.5	20
40-125(I)A	8	2.22	17	47	2900	1.1	2.3	415	305	90	120	70	315	165	90	440	465	210	260	Φ150	Φ110	4-Φ18	SD41-0.5	20
	11	3.05	16	57				415	305	90	120	70	315	165	90	440	465	210	260	Φ150	Φ110	4-Φ18	SD41-0.5	20
	14.5	4.03	14	54				415	305	90	120	70	315	165	90	440	465	210	260	Φ150	Φ110	4-Φ18	SD41-0.5	20
40-160(I)	8.8	2.44	33	45	2900	3	2.3	505	325	100	135	80	380	220	85	485	540	280	320	Φ150	Φ110	4-Φ18	SD41-0.5	20
	12.5	3.47	32	52				505	325	100	135	80	380	220	85	485	540	280	320	Φ150	Φ110	4-Φ18	SD41-0.5	20
	16.3	4.53	30	52				505	325	100	135	80	380	220	85	485	540	280	320	Φ150	Φ110	4-Φ18	SD41-0.5	20
40-160(I)A	8.2	2.28	29	44	2900	2.2	2.3	465	325	100	135	80	380	220	85	455	495	280	310	Φ150	Φ110	4-Φ18	SD41-0.5	20
	11.7	3.25	28	41				465	325	100	135	80	380	220	85	455	495	280	310	Φ150	Φ110	4-Φ18	SD41-0.5	20
	15.2	4.22	26	50				465	325	100	135	80	380	220	85	455	495	280	310	Φ150	Φ110	4-Φ18	SD41-0.5	20
40-160(I)B	7.8	2.38	23	44	2900	1.5	2.3	440	325	100	135	80	380	220	85	455	495	280	310	Φ150	Φ110	4-Φ18	SD41-0.5	20
	10.4	2.89	22	49				440	325	100	135	80	380	220	85	455	495	280	310	Φ150	Φ110	4-Φ18	SD41-0.5	20
	13.5	3.75	20.5	47				440	325	100	135	80	380	220	85	455	495	280	310	Φ150	Φ110	4-Φ18	SD41-0.5	20
40-200(I)	8.8	2.44	51.2	38	2900	5.5	2.3	580	370	95	135	80	400	220	100	535	590	340	340	Φ150	Φ110	4-Φ18	SD41-0.5	20
	12.5	3.47	50	46				580	370	95	135	80	400	220	100	535	590	340	340	Φ150	Φ110	4-Φ18	SD41-0.5	20
	16.3	4.53	48	46				580	370	95	135	80	400	220	100	535	590	340	340	Φ150	Φ110	4-Φ18	SD41-0.5	20
40-200(I)A	8.3	2.31	45	37	2900	4	2.3	530	370	95	135	80	400	220	100	490	580	300	340	Φ150	Φ110	4-Φ18	SD41-0.5	20
	11.7	3.25	44	45				530	370	95	135	80	400	220	100	490	580	300	340	Φ150	Φ110	4-Φ18	SD41-0.5	20
	15.3	4.25	42	45				530	370	95	135	80	400	220	100	490	580	300	340	Φ150	Φ110	4-Φ18	SD41-0.5	20
40-200(I)B	7.5	2.08	37	35	2900	3	2.3	500	370	95	135	80	410	230	100	490	550	300	340	Φ150	Φ110	4-Φ18	SD41-0.5	20
	10.6	2.94	36	44				500	370	95	135	80	410	230	100	490	550	300	340	Φ150	Φ110	4-Φ18	SD41-0.5	20
	13.8	3.83	34	42				500	370	95	135	80	410	230	100	490	550	300	340	Φ150	Φ110	4-Φ18	SD41-0.5	20
40-250(I)A	8.2	2.28	71	28	2900	7.5	2.3	585	440	100	160	100	480	255	100	540	645	340	380	Φ150	Φ110	4-Φ18	SD41-0.5	20
	11.6	3.22	70	38				585	440	100	160	100	480	255	100	540	645	340	380	Φ150	Φ110	4-Φ18	SD41-0.5	20
	15.2	4.22	68	39				585	440	100	160	100	480	255	100	540	645	340	380	Φ150	Φ110	4-Φ18	SD41-0.5	20
40-250(I)B	7.6	2.11	61.4	28	2900	7.5	2.3	585	440	100	160	100	480	255	100	540	645	340	380	Φ150	Φ110	4-Φ18	SD41-0.5	20
	10.8	3	60	37				585	440	100	160	100	480	255	100	540	645	340	380	Φ150	Φ110	4-Φ18	SD41-0.5	20
	14	3.89	58	37				585	440	100	160	100	480	255	100	540	645	340	380	Φ150	Φ110	4-Φ18	SD41-0.5	20
40-250(I)C	7.1	1.97	53.2	26	2900	5.5	2.3	585	440	100	160	100	480	255	100	540	645	340	380	Φ150	Φ110	4-Φ18	SD41-0.5	20
	10	2.78	52	36				585	440	100	160	100	480	255	100	540	645	340	380	Φ150	Φ110	4-Φ18	SD41-0.5	20
	13.1	3.64	50.4	35				585	440	100	160	100	480	255	100	540	645	340	380	Φ150	Φ110	4-Φ18	SD41-0.5	20

Technical Parameter

Model	Flow Q		Head (m)	Eta (%)	Speed (r/min)	Power (kW)	NPSH (m)	Vertical Type Installation Size					Horizontal Type Installation Size					Flange Size			Vibration Isolators Spec	H1		
	m³/h	L/s						H	L	h	B	C	H	h	a	L1	L	L2	B1	D			D1	n-d
50-100	8.8	2.44	13.6	55	2900	1.1	2.3	420	300	95	120	65	310	167	80	405	470	210	260	Φ165	Φ125	4-Φ18	SD41-0.5	20
	12.5	3.47	12.5	62				420	300	95	120	65	310	167	80	405	470	210	260	Φ165	Φ125	4-Φ18	SD41-0.5	20
	16.3	4.53	11.3	60				420	300	95	120	65	310	167	80	405	470	210	260	Φ165	Φ125	4-Φ18	SD41-0.5	20
50-100A	8	2.22	11	52	2900	0.75	2.3	420	300	95	120	65	310	167	80	405	470	210	260	Φ165	Φ125	4-Φ18	SD41-0.5	20
	11	3.05	10	60				420	300	95	120	65	310	167	80	405	470	210	260	Φ165	Φ125	4-Φ18	SD41-0.5	20
	14.5	4.03	9	56				420	300	95	120	65	310	167	80	405	470	210	260	Φ165	Φ125	4-Φ18	SD41-0.5	20
50-125	8.8	2.44	21.5	49	2900	1.5	2.3	430	305	90	115	70	320	170	90	455	480	285	270	Φ165	Φ125	4-Φ18	SD41-0.5	20
	12.5	3.47	20	58				430	305	90	115	70	320	170	90	455	480	285	270	Φ165	Φ125	4-Φ18	SD41-0.5	20
	16.3	4.53	17.8	57				430	305	90	115	70	320	170	90	455	480	285	270	Φ165	Φ125	4-Φ18	SD41-0.5	20
50-125A	8	2.22	17	47	2900	1.1	2.3	415	305	90	115	70	315	170	90	405	465	210	260	Φ165	Φ125	4-Φ18	SD41-0.5	20
	11	3.05	16	57				415	305	90	115	70	315	170	90	405	465	210	260	Φ165	Φ125	4-Φ18	SD41-0.5	20
	14.5	4.03	14	54				415	305	90	115	70	315	170	90	405	465	210	260	Φ165	Φ125	4-Φ18	SD41-0.5	20
50-160	8.8	2.44	33	45	2900	3	2.3	505	325	85	135	85	355	187	85	495	535	310	320	Φ165	Φ125	4-Φ18	SD41-0.5	20
	12.5	3.47	32	52				505	325	85	135	85	355	187	85	495	535	310	320	Φ165	Φ125	4-Φ18	SD41-0.5	20
	16.3	4.53	30	51				505	325	85	135	85	355	187	85	495	535	310	320	Φ165	Φ125	4-Φ18	SD41-0.5	20
50-160A	8.2	2.28	29	44	2900	2.2	2.3	465	325	85	135	85	355	187	85	495	495	310	320	Φ165	Φ125	4-Φ18	SD41-0.5	20
	11.7	3.25	28	51				465	325	85	135	85	355	187	85	495	495	310	320	Φ165	Φ125	4-Φ18	SD41-0.5	20
	15.2	4.22	26	50				465	325	85	135	85	355	187	85	495	495	310	320	Φ165	Φ125	4-Φ18	SD41-0.5	20
50-160B	7.3	2.13	23	42	2900	1.5	2.3	440	325	85	135	85	385	220	85	45								

Technical Parameter

Model	Flow Q		Head (m)	Eta (%)	Speed (r/min)	Power (kW)	NPSH (m)	Vertical Type Installation Size					Horizontal Type Installation Size					Flange Size			Vibration Isolators Spec	H1		
	m³/h	L/s						H	L	h	B	C	H	h	a	L1	L	L2	B1	D			D1	n-d
50-100(I)	17.5	4.86	13.7	67	2900	1.5	2.5	440	315	90	160	100	370	210	95	440	510	300	350	Φ165	Φ125	4-Φ18	SD41-0.5	20
	25	6.94	12.5	69				440	315	90	160	100	370	210	95	440	510	300	350	Φ165	Φ125	4-Φ18	SD41-0.5	20
	32.5	9.02	10	70				440	315	90	160	100	370	210	95	440	510	300	350	Φ165	Φ125	4-Φ18	SD41-0.5	20
50-100(I)A	15.6	4.3	11	65	2900	1.1	2.5	425	315	90	160	100	370	210	95	440	470	250	300	Φ165	Φ125	4-Φ18	SD41-0.5	20
	22.3	6.19	10	67				425	315	90	160	100	370	210	95	440	470	250	300	Φ165	Φ125	4-Φ18	SD41-0.5	20
	29	8.1	8.4	68				425	315	90	160	100	370	210	95	440	470	250	300	Φ165	Φ125	4-Φ18	SD41-0.5	20
50-125(I)	17.5	4.86	21.5	60	2900	3	2.5	480	370	110	160	100	335	165	95	480	555	303	292	Φ165	Φ125	4-Φ18	SD41-0.5	20
	25	6.94	20	68				480	370	110	160	100	335	165	95	480	555	303	292	Φ165	Φ125	4-Φ18	SD41-0.5	20
	32.5	9.03	18	67				480	370	110	160	100	335	165	95	480	555	303	292	Φ165	Φ125	4-Φ18	SD41-0.5	20
50-125(I)A	15.6	4.33	17	58	2900	2.2	2.5	480	370	110	160	100	335	165	95	480	515	303	292	Φ165	Φ125	4-Φ18	SD41-0.5	20
	22.3	6.19	16	66				480	370	110	160	100	335	165	95	480	515	303	292	Φ165	Φ125	4-Φ18	SD41-0.5	20
	29	8.05	13	68				480	370	110	160	100	335	165	95	480	515	303	292	Φ165	Φ125	4-Φ18	SD41-0.5	20
50-160(I)	17.5	4.86	34.4	54	2900	4	2.5	540	355	100	160	100	405	230	80	505	665	280	350	Φ165	Φ125	4-Φ18	SD41-0.5	20
	25	6.94	32	63				540	355	100	160	100	405	230	80	505	665	280	350	Φ165	Φ125	4-Φ18	SD41-0.5	20
	32.5	9.03	27.5	60				540	355	100	160	100	405	230	80	505	665	280	350	Φ165	Φ125	4-Φ18	SD41-0.5	20
50-160(I)A	16.4	4.56	30	54	2900	4	2.3	540	355	100	160	100	405	230	80	505	665	300	350	Φ165	Φ125	4-Φ18	SD41-0.5	20
	23.4	6.5	28	52				540	355	100	160	100	405	230	80	505	665	300	350	Φ165	Φ125	4-Φ18	SD41-0.5	20
	30.4	8.44	24	59				540	355	100	160	100	405	230	80	505	665	300	350	Φ165	Φ125	4-Φ18	SD41-0.5	20
50-160(I)B	15	4.17	26	49	2900	3	2.3	510	355	100	160	100	405	230	85	505	640	300	350	Φ165	Φ125	4-Φ18	SD41-0.5	20
	21.6	6	24	58				510	355	100	160	100	405	230	85	505	640	300	350	Φ165	Φ125	4-Φ18	SD41-0.5	20
	28	7.78	20.6	54				510	355	100	160	100	405	230	85	505	640	300	350	Φ165	Φ125	4-Φ18	SD41-0.5	20
50-200(I)	17.5	4.86	52.7	49	2900	7.5	2.3	595	390	105	160	100	405	220	100	535	640	340	340	Φ165	Φ125	4-Φ18	SD41-0.5	20
	25	6.94	50	58				595	390	105	160	100	405	220	100	535	640	340	340	Φ165	Φ125	4-Φ18	SD41-0.5	20
	32.5	9.03	45.5	59				595	390	105	160	100	405	220	100	535	640	340	340	Φ165	Φ125	4-Φ18	SD41-0.5	20
50-200(I)A	16.4	4.56	46.4	48	2900	7.5	2.3	595	390	105	160	100	405	220	100	535	640	340	340	Φ165	Φ125	4-Φ18	SD41-0.5	20
	23.5	6.53	44	57				595	390	105	160	100	405	220	100	535	640	340	340	Φ165	Φ125	4-Φ18	SD41-0.5	20
	30.5	8.47	40	58				595	390	105	160	100	405	220	100	535	640	340	340	Φ165	Φ125	4-Φ18	SD41-0.5	20
50-200(I)B	15.2	4.22	40	45	2900	5.5	2.3	595	390	105	160	100	405	220	100	535	640	340	340	Φ165	Φ125	4-Φ18	SD41-0.5	20
	21.8	6.06	38	55				595	390	105	160	100	405	220	100	535	640	340	340	Φ165	Φ125	4-Φ18	SD41-0.5	20
	28.3	7.86	34.5	55				595	390	105	160	100	405	220	100	535	640	340	340	Φ165	Φ125	4-Φ18	SD41-0.5	20
50-250(I)	17.5	4.86	82	39	2900	15	2.3	695	475	120	170	115	515	270	105	695	740	430	440	Φ165	Φ125	4-Φ18	SD41-0.5	20
	25	6.94	80	50				695	475	120	170	115	515	270	105	695	740	430	440	Φ165	Φ125	4-Φ18	SD41-0.5	20
	32.5	9.03	76.5	52				695	475	120	170	115	515	270	105	695	740	430	440	Φ165	Φ125	4-Φ18	SD41-0.5	20
65-100	17.5	4.86	13.7	67	2900	1.5	2.5	495	400	122	160	100	380	220	95	455	510	280	310	Φ185	Φ145	4-Φ18	SD41-0.5	20
	25	6.94	12.5	69				495	400	122	160	100	380	220	95	455	510	280	310	Φ185	Φ145	4-Φ18	SD41-0.5	20
	32.5	9.03	10.5	69				495	400	122	160	100	380	220	95	455	510	280	310	Φ185	Φ145	4-Φ18	SD41-0.5	20
65-100A	15.6	4.3	11	65	2900	1.1	2.5	455	400	122	160	100	380	220	95	440	470	250	300	Φ185	Φ145	4-Φ18	SD41-0.5	20
	22.3	6.19	10	67				455	400	122	160	100	380	220	95	440	470	250	300	Φ185	Φ145	4-Φ18	SD41-0.5	20
	29	8.1	8.4	68				455	400	122	160	100	380	220	95	440	470	250	300	Φ185	Φ145	4-Φ18	SD41-0.5	20

Technical Parameter

Model	Flow Q		Head (m)	Eta (%)	Speed (r/min)	Power (kW)	NPSH (m)	Vertical Type Installation Size					Horizontal Type Installation Size					Flange Size			Vibration Isolators Spec	H1		
	m³/h	L/s						H	L	h	B	C	H	h	a	L1	L	L2	B1	D			D1	n-d
65-100	17.5	4.86	13.7	67	2900	1.5	2.5	495	400	122	160	100	380	220	95	455	510	280	310	Φ185	Φ145	4-Φ18	SD41-0.5	20
	25	6.94	12.5	69				495	400	122	160	100	380	220	95	455	510	280	310	Φ185	Φ145	4-Φ18	SD41-0.5	20
	32.5	9.03	10.5	69				495	400	122	160	100	380	220	95	455	510	280	310	Φ185	Φ145	4-Φ18	SD41-0.5	20
65-100A	15.6	4.3	11	65	2900	1.1	2.5	455	400	122	160	100	380	220	95	440	470	250	300	Φ185	Φ145	4-Φ18	SD41-0.5	20
	22.3	6.19	10	67				455	400	122	160	100	380	220	95	440	470	250	300	Φ185	Φ145	4-Φ18	SD41-0.5	20
	29	8.1	8.4	68				455	400	122	160	100	380	220	95	440	470	250	300	Φ185	Φ145	4-Φ18	SD41-0.5	20
65-125	17.5	4.86	21.5	60	2900	3	2.5	480	345	112	160	100	335	165	85	480	530	303	292	Φ185	Φ145	4-Φ18	SD41-0.5	20
	25	6.94	20	68				480	345	112	160	100	335	165	85	480	530	303	292	Φ185	Φ145	4-Φ18	SD41-0.5	20
	32.5	9.03	18	67				480	345	112	160	100	335	165	85	480	530	303	292	Φ185	Φ145	4-Φ18	SD41-0.5	20
65-125A	15.6	4.33	17	58	2900	2.2	2.5	480	365	112	160	100	335	165	85	480	505	303	292	Φ185	Φ145	4-Φ18	SD41-0.5	20
	22.3	6.19	16	66				480	365	112	160	100	335	165	85	480	505	303	292	Φ185	Φ145	4-Φ18	SD41-0.5	20
	29	8.06	14.4	65				480	365	112	160	100	335	165	85	480	505	303	292	Φ185	Φ145	4-Φ18	SD41-0.5	20
65-160	17.5	4.86	34.4	54	2900	4	2.5	540	360	105	160	100	367	187	85	495	575	310	315	Φ185	Φ145	4-Φ18	SD41-0.5	20
	25	6.94	32	63				540	360	105	160	100	367	187	85	495	575	310	315	Φ185	Φ145	4-Φ18	SD41-0.5	20
	32.5	9.03	27.5	60				540	360	105	160	100	367	187	85	495	575	310	315	Φ185	Φ145	4-Φ18	SD41-0.5	20
65-160A	16.4	4.56	30	54	2900	4	2.5	540	360	105	160	100	405	230	80	505	575	300	350	Φ185	Φ145	4-Φ18	SD41-0.5	20
	23.4	6.5	28	63				540	360	105	160	100	405	230	80	505	575	300	350	Φ185	Φ145	4-Φ18	SD41-0.5	20
	30.4	8.44	24	59				540	360	105	160	100	405	230	80	505	575	300	350	Φ185	Φ145	4-Φ18	SD41-0.5	20
65-160B	15.1	4.17	26	49	2900	3	2.5																	

Technical Parameter

Model	Flow Q		Head (m)	Eta (%)	Speed (r/min)	Power (kW)	NPSH (m)	Vertical Type Installation Size					Horizontal Type Installation Size					Flange Size			Vibration Isolators Spec	H1			
	m³/h	L/s						H	L	h	B	C	H	h	a	L1	L	L2	B1	D			D1	n-d	
65-250A	16.4	4.56	71.5	39	2900	11	2.5	695	475	120	172	115	500	270	105	695	740	430	440	Φ185	Φ145	4-Φ18	SD41-0.5	20	
	23.4	6.51	70	50				695	475	120	172	115	500	270	105	695	740	430	440	Φ185	Φ145	4-Φ18	SD41-0.5	20	
	30.5	8.47	67	52				695	475	120	172	115	500	270	105	695	740	430	440	Φ185	Φ145	4-Φ18	SD41-0.5	20	
65-250A	7	1.94	18	49	1450	1.5	2.8	520	485	120	180	120	480	250	105	695	740	430	440	Φ185	Φ145	4-Φ18	SD41-0.5	20	
	11.7	3.25	17.5					520	485	120	180	120	480	250	105	695	740	430	440	Φ185	Φ145	4-Φ18	SD41-0.5	20	
	15.3	4.3	17					520	485	120	180	120	480	250	105	695	740	430	440	Φ185	Φ145	4-Φ18	SD41-0.5	20	
65-250B	15	4.17	61	49	2900	11	2.5	695	485	120	180	120	500	270	105	695	740	430	440	Φ185	Φ145	4-Φ18	SD41-0.5	20	
	21.6	6	60					695	485	120	180	120	500	270	105	695	740	430	440	Φ185	Φ145	4-Φ18	SD41-0.5	20	
	28	7.78	57.4					695	485	120	180	120	500	270	105	695	740	430	440	Φ185	Φ145	4-Φ18	SD41-0.5	20	
65-250B	6	1.67	15.6	48	1450	1.1	2.8	505	485	120	180	120	480	250	105	695	740	430	440	Φ185	Φ145	4-Φ18	SD41-0.5	20	
	11	2.78	15					505	485	120	180	120	480	250	105	695	740	430	440	Φ185	Φ145	4-Φ18	SD41-0.5	20	
	14	3.9	14.4					505	485	120	180	120	480	250	105	695	740	430	440	Φ185	Φ145	4-Φ18	SD41-0.5	20	
65-315	7.5	2.08	32.5	41	1450	4	2.8	640	550	135	180	120	555	280	130	740	930	405	460	Φ185	Φ145	4-Φ18	SD41-0.5	20	
	12.5	3.47	32					640	550	135	180	120	555	280	130	740	930	405	460	Φ185	Φ145	4-Φ18	SD41-0.5	20	
	16.3	4.53	31.5					640	550	135	180	120	555	280	130	740	930	405	460	Φ185	Φ145	4-Φ18	SD41-0.5	20	
65-315A	16.6	4.61	115	32	2900	2.2	2.5	785	550	130	180	120	565	290	130	740	850	405	460	Φ185	Φ145	4-Φ18	SD41-0.5	20	
	23.7	6.58	113					40	785	550	130	180	120	565	290	130	740	850	405	460	Φ185	Φ145	4-Φ18	SD41-0.5	20
	31	8.6	110					44	785	550	130	180	120	565	290	130	740	850	405	460	Φ185	Φ145	4-Φ18	SD41-0.5	20
65-315A	7	1.94	28.8	41	1450	3	2.8	615	550	135	180	120	555	280	130	740	850	405	460	Φ185	Φ145	4-Φ18	SD41-0.5	20	
	11.7	3.25	28					615	550	135	180	120	555	280	130	740	850	405	460	Φ185	Φ145	4-Φ18	SD41-0.5	20	
	15.3	4.3	27.5					615	550	135	180	120	555	280	130	740	850	405	460	Φ185	Φ145	4-Φ18	SD41-0.5	20	
65-100(I)	35	9.72	13.8	67	2900	3	3	535	400	130	160	100	380	220	95	505	560	300	350	Φ185	Φ145	4-Φ18	SD41-0.5	20	
	50	13.9	12.5					73	535	400	130	160	100	380	220	95	505	560	300	350	Φ185	Φ145	4-Φ18	SD41-0.5	20
	65	18.1	10					70	535	400	130	160	100	380	220	95	505	560	300	350	Φ185	Φ145	4-Φ18	SD41-0.5	20
65-100(I)A	32.3	8.7	11	66	2900	2.2	3	495	400	130	160	100	370	210	95	485	535	280	320	Φ185	Φ145	4-Φ18	SD41-0.5	20	
	44.7	12.4	10					72	495	400	130	160	100	370	210	95	485	535	280	320	Φ185	Φ145	4-Φ18	SD41-0.5	20
	58	16.1	8					69	495	400	130	160	100	370	210	95	485	535	280	320	Φ185	Φ145	4-Φ18	SD41-0.5	20
65-125(I)	35	9.72	22	67	2900	5.5	3	600	405	125	160	100	385	220	105	535	630	340	340	Φ185	Φ145	4-Φ18	SD41-0.5	20	
	50	13.9	20					72.5	600	405	125	160	100	385	220	105	535	630	340	340	Φ185	Φ145	4-Φ18	SD41-0.5	20
	65	18.1	17					70	600	405	125	160	100	385	220	105	535	630	340	340	Φ185	Φ145	4-Φ18	SD41-0.5	20
65-125(I)A	31.3	8.7	17.5	66	2900	4	3	600	405	125	160	100	385	220	105	490	590	300	340	Φ185	Φ145	4-Φ18	SD41-0.5	20	
	45	12.5	16					71	600	405	125	160	100	385	220	105	490	590	300	340	Φ185	Φ145	4-Φ18	SD41-0.5	20
	58	16.1	13.6					69	600	405	125	160	100	385	220	105	490	590	300	340	Φ185	Φ145	4-Φ18	SD41-0.5	20
65-160(I)	35	9.75	35	63	2900	7.5	3	595	405	120	160	100	420	220	100	535	635	340	340	Φ185	Φ145	4-Φ18	SD41-0.5	20	
	50	13.9	32					71	595	405	120	160	100	420	220	100	535	635	340	340	Φ185	Φ145	4-Φ18	SD41-0.5	20
	65	18.1	28					70	595	405	120	160	100	420	220	100	535	635	340	340	Φ185	Φ145	4-Φ18	SD41-0.5	20
65-160(I)A	32.7	9.7	30.6	62	2900	7.5	3	595	405	120	160	100	420	220	100	535	625	340	340	Φ185	Φ145	4-Φ18	SD41-0.5	20	
	46.7	13	28					70	595	405	120	160	100	420	220	100	535	625	340	340	Φ185	Φ145	4-Φ18	SD41-0.5	20
	61	16.9	24					69	595	405	120	160	100	420	220	100	535	625	340	340	Φ185	Φ145	4-Φ18	SD41-0.5	20

Technical Parameter

Model	Flow Q		Head (m)	Eta (%)	Speed (r/min)	Power (kW)	NPSH (m)	Vertical Type Installation Size					Horizontal Type Installation Size					Flange Size			Vibration Isolators Spec	H1		
	m³/h	L/s						H	L	h	B	C	H	h	a	L1	L	L2	B1	D			D1	n-d
65-160(I)B	30.3	8.4	26	60	2900	5.5	3	595	405	120	160	100	420	220	100	535	625	340	340	Φ185	Φ145	4-Φ18	SD41-0.5	20
	43.3	12	24	69				595	405	120	160	100	420	220	100	535	625	340	340	Φ185	Φ145	4-Φ18	SD41-0.5	20
	56.3	15.6	21	67				595	405	120	160	100	420	220	100	535	625	340	340	Φ185	Φ145	4-Φ18	SD41-0.5	20
65-200(I)B	30.5	8.5	40.6	52	2900	7.5	3	715	455	135	160	100	440	255	100	540	630	340	380	Φ185	Φ145	4-Φ18	SD41-0.5	20
	43.5	12.1	38	65				715	455	135	160	100	440	255	100	540	630	340	380	Φ185	Φ145	4-Φ18	SD41-0.5	20
	56.6	15.7	33.4	65				715	455	135	160	100	440	255	100	540	630	340	380	Φ185	Φ145	4-Φ18	SD41-0.5	20
80-100	35	9.72	13.8	67	2900	3	3	535	400	125	160	100	380	220	95	505	560	300	350	Φ200	Φ160	8-Φ18	SD41-0.5	20
	50	13.9	12.5	73				535	400	125	160	100	380	220	95	505	560	300	350	Φ200	Φ160	8-Φ18	SD41-0.5	20
	65	18.1	10	70				535	400	125	160	100	380	220	95	505	560	300	350	Φ200	Φ160	8-Φ18	SD41-0.5	20
80-100A	31.3	8.7	11	66	2900	2.2	3	495	405	125	160	100	370	210	95	485	535	280	320	Φ200	Φ160	8-Φ18	SD41-0.5	20
	44.7	12.4	10	72				495	405	125	160	100	370	210	95	485	535	280	320	Φ200	Φ160	8-Φ18	SD41-0.5	20
	58	16.1	8	69				495	405	125	160	100	370	210	95	485	535	280	320	Φ200	Φ160	8-Φ18	SD41-0.5	20
80-125	35	9.72	22	67	2900	5.5	3	600	405	125	160	100	385	220	105	535	630	340	340	Φ200	Φ160	8-Φ18	SD41-0.5	20
	50</																							

Technical Parameter

Model	Flow Q		Head (m)	Eta (%)	Speed (r/min)	Power (kW)	NPSH (m)	Vertical Type Installation Size					Horizontal Type Installation Size					Flange Size			Vibration Isolators Spec	H1		
	m³/h	L/s						H	L	h	B	C	H	h	a	L1	L	L2	B1	D			D1	n-d
80-315	15	4.17	32.5	53	1450	5.5	2.8	685	585	135	220	160	620	315	140	795	685	640	430	Φ200	Φ160	8-Φ18	SD41-0.5	20
	25	6.94	32					685	585	135	220	160	620	315	140	795	685	640	430	Φ200	Φ160	8-Φ18	SD41-0.5	20
	32.5	9.03	31.5					685	585	135	220	160	620	315	140	795	685	640	430	Φ200	Φ160	8-Φ18	SD41-0.5	20
80-315A	13.3	3.75	26.8	51	1450	4	2.8	640	485	130	180	120	510	270	125	975	640	640	430	Φ200	Φ160	8-Φ18	SD41-0.5	20
	23	6.25	27.9					640	485	130	180	120	510	270	125	975	640	640	430	Φ200	Φ160	8-Φ18	SD41-0.5	20
	29	8.06	24.5					640	485	130	180	120	510	270	125	975	640	640	430	Φ200	Φ160	8-Φ18	SD41-0.5	20
80-315B	12	3.38	21.4	49	1450	3	2.8	615	485	130	180	120	510	270	125	975	615	640	430	Φ200	Φ160	8-Φ18	SD41-0.5	20
	20	5.56	21					615	485	130	180	120	510	270	125	975	615	640	430	Φ200	Φ160	8-Φ18	SD41-0.5	20
	24	6.67	20.6					615	485	130	180	120	510	270	125	975	615	640	430	Φ200	Φ160	8-Φ18	SD41-0.5	20
80-100(I)	70	19.4	13.6	66	2900	5.5	4.5	615	460	140	180	120	425	220	115	535	665	340	340	Φ200	Φ160	8-Φ18	SD41-0.5	20
	100	27.8	12.5					615	460	140	180	120	425	220	115	535	665	340	340	Φ200	Φ160	8-Φ18	SD41-0.5	20
	130	36.1	11					615	460	140	180	120	425	220	115	535	665	340	340	Φ200	Φ160	8-Φ18	SD41-0.5	20
80-100(I)A	62.6	17.4	11	70	2900	4	4.5	575	460	140	180	120	425	220	115	490	620	300	340	Φ200	Φ160	8-Φ18	SD41-0.5	20
	89	24.7	10					575	460	140	180	120	425	220	115	490	620	300	340	Φ200	Φ160	8-Φ18	SD41-0.5	20
	116	32.2	8.8					575	460	140	180	120	425	220	115	490	620	300	340	Φ200	Φ160	8-Φ18	SD41-0.5	20
80-125(I)A	62.6	17.4	19	65	2900	7.5	4.5	615	455	140	180	120	460	255	120	540	670	340	380	Φ200	Φ160	8-Φ18	SD41-0.5	20
	89	24.7	16					615	455	140	180	120	460	255	120	540	670	340	380	Φ200	Φ160	8-Φ18	SD41-0.5	20
	116	32.2	11					615	455	140	180	120	460	255	120	540	670	340	380	Φ200	Φ160	8-Φ18	SD41-0.5	20
100-100	70	19.4	13.6	66	2900	5.5	4.5	615	460	140	180	120	435	220	100	535	340	338	345	Φ220	Φ185	8-Φ18	SD41-0.5	20
	100	27.7	12.5					615	460	140	180	120	435	220	100	535	340	338	345	Φ220	Φ185	8-Φ18	SD41-0.5	20
	130	36.1	11					615	460	140	180	120	435	220	100	535	340	338	345	Φ220	Φ185	8-Φ18	SD41-0.5	20
100-100A	62.6	17.4	11	64	2900	4	4.5	575	460	140	180	120	425	220	115	490	300	430	340	Φ220	Φ185	8-Φ18	SD41-0.5	20
	89	24.7	10					575	460	140	180	120	425	220	115	490	300	430	340	Φ220	Φ185	8-Φ18	SD41-0.5	20
	116	32.2	8.8					575	460	140	180	120	425	220	115	490	300	430	340	Φ220	Φ185	8-Φ18	SD41-0.5	20
100-125A	62.6	17.4	19	68	2900	7.5	4.5	615	445	140	180	120	460	255	120	540	670	340	380	Φ220	Φ185	8-Φ18	SD41-0.5	20
	89	24.7	16					615	445	140	180	120	460	255	120	540	670	340	380	Φ220	Φ185	8-Φ18	SD41-0.5	20
	116	32.2	11					615	445	140	180	120	460	255	120	540	670	340	380	Φ220	Φ185	8-Φ18	SD41-0.5	20
100-160	30	8.33	9.2	75	1400	2.2	3	575	510	155	160	100	525	270	100	975	740	640	430	Φ220	Φ185	8-Φ18	SD41-0.5	20
	50	13.9	8					575	510	155	160	100	525	270	100	975	740	640	430	Φ220	Φ185	8-Φ18	SD41-0.5	20
	65	18.1	6.8					575	510	155	160	100	525	270	100	975	740	640	430	Φ220	Φ185	8-Φ18	SD41-0.5	20
100-160A	28	7.78	8	73	1450	1.5	3	575	510	155	160	100	525	270	100	1000	740	640	430	Φ220	Φ185	8-Φ18	SD41-0.5	20
	46.8	13	7					575	510	155	160	100	525	270	100	1000	740	640	430	Φ220	Φ185	8-Φ18	SD41-0.5	20
	60.5	16.8	6					575	510	155	160	100	525	270	100	1000	740	640	430	Φ220	Φ185	8-Φ18	SD41-0.5	20
100-200	30	8.33	13.5	74	1450	3	3	610	475	135	180	125	505	265	100	975	580	640	430	Φ220	Φ185	8-Φ18	SD41-0.5	20
	50	13.9	12.5					610	475	135	180	125	505	265	100	975	580	640	430	Φ220	Φ185	8-Φ18	SD41-0.5	20
	65	18.1	10.5					610	475	135	180	125	505	265	100	975	580	640	430	Φ220	Φ185	8-Φ18	SD41-0.5	20
100-200A	26.4	7.33	11.9	72	1450	2.2	3	585	475	135	180	125	510	270	100	975	580	430	430	Φ220	Φ185	8-Φ18	SD41-0.5	20
	44.6	13	9.9					585	475	135	180	125	510	270	100	975	580	430	430	Φ220	Φ185	8-Φ18	SD41-0.5	20
	60.5	16.8	9.3					585	475	135	180	125	510	270	100	975	580	430	430	Φ220	Φ185	8-Φ18	SD41-0.5	20

Technical Parameter

Model	Flow Q		Head (m)	Eta (%)	Speed (r/min)	Power (kW)	NPSH (m)	Vertical Type Installation Size					Horizontal Type Installation Size					Flange Size			Vibration Isolators Spec	H1		
	m³/h	L/s						H	L	h	B	C	H	h	a	L1	L	L2	B1	D			D1	n-d
100-250	30	8.33	21.8	70	1450	5.5	3	690	550	140	180	120	565	290	130	975	685	640	430	Φ220	Φ185	8-Φ18	SD41-0.5	20
	50	13.9	20					690	550	140	180	120	565	290	130	975	685	640	430	Φ220	Φ185	8-Φ18	SD41-0.5	20
	65	18.1	18					690	550	140	180	120	565	290	130	975	685	640	430	Φ220	Φ185	8-Φ18	SD41-0.5	20
100-250A	28	7.78	19	68	1450	4	3	665	550	140	180	120	565	290	130	975	660	640	430	Φ220	Φ185	8-Φ18	SD41-0.5	20
	46.7	13	17.4					665	550	140	180	120	565	290	130	975	660	640	430	Φ220	Φ185	8-Φ18	SD41-0.5	20
	60.5	16.8	15.5					665	550	140	180	120	565	290	130	975	660	640	430	Φ220	Φ185	8-Φ18	SD41-0.5	20
100-250B	24	6.67	16.3	65	1450	3	3	640	550	140	180	120	565	290	130	975	635	640	430	Φ220	Φ185	8-Φ18	SD41-0.5	20
	43.5	12.1	15					640	550	140	180	120	565	290	130	975	635	640	430	Φ220	Φ185	8-Φ18	SD41-0.5	20
	56.5	15.7	13.8					640	550	140	180	120	565	290	130	975	635	640	430	Φ220	Φ185	8-Φ18	SD41-0.5	20
100-315A	28	7.78	30	64	1450	7.5	3	780	645	160	270	185	670	340	135	740	725	405	460	Φ220	Φ185	8-Φ18	SD41-1	20
	47.5	13	28					780	645	160	270	185	670	340	135	740	725	405	460	Φ220	Φ185	8-Φ18	SD41-1	20
	61.5	16.8	26					780	645	160	270	185	670	340	135	740	725	405	460	Φ220	Φ185	8-Φ18	SD41-1	20
100-315B	24	6.67	22.5	63	1450	5.5	3	750	645	160	270	185	670	340	135	740	725	405	460	Φ220	Φ185	8-Φ18	SD41-1	20
	40.5	11.25	21					750	645	160	270	185	670	340	135	740	725	405	460	Φ220	Φ185			

LT/WLT

Closed Cooling Tower Special Pump



Private House



Civil use



Industrial use



Product Overview

LT(WLT) closed cooling tower special pump is a large-flow low-lift pump with a lift range of 3~8m. Be settled vertically or horizontally. The pump adopts a standard wear-resistant mechanical seal, which is reliable in use in a longer service life. This series uses a compact and rational structure whose features are smooth operation, low noise, small size, easy maintenance etc. The main shaft for the LT(WLT) series and its motor shaft adopts a coaxial connection structure.

Application

- Water circulation in closed cooling towers and condensers
- Cooling for various machines and equipment
- Normal water supply

Working Conditions

- For conveying liquids that are non-flammable, non-corrosive and have no solid particles or fibres.
- Liquid temperature: -15°C ~100°C
- Environment temperature: ≤ 40°C
- Working pressure: ≤ 6bar

Model Implication

LT(WLT) 100 - 5 A / 2.2

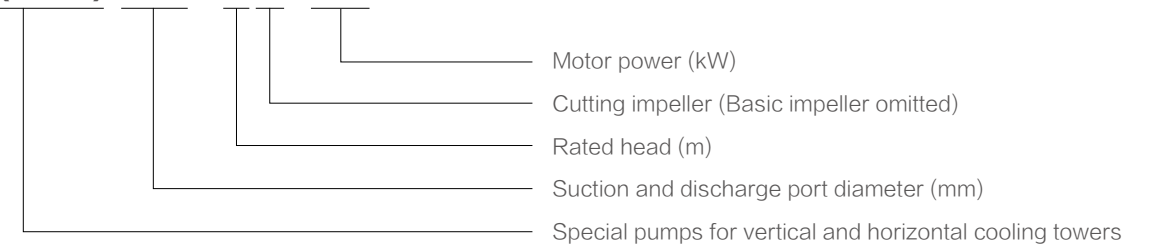

Technical Parameters

Model	Flow	Head	Inlet and outlet caliber	Power	Speed	Current	Voltage	Eff.	Power factor
	m ³ /h	m	mm	kW	r/min	A	V	%	cos*
LT(WLT)65-5/1.1	40	5	65	1.2/2	2825	2.6	380	79	0.84
LT(WLT)80-5/1.5	55	5	80	1.5/2	2840	3.4	380	81	0.84
LT(WLT)100-5A/2.2	80	5	100	2.2/4	1450	4.9	380	81	0.85
LT(WLT)100-5/2.2	120	5	100	2.2/4	1450	5.16	380	80	0.81
LT(WLT)125-5A/3	150	5	125	3.0/4	1450	6.8	380	83	0.87
LT(WLT)125-5/4	180	5	125	4.0/4	1450	8.8	380	85	0.88
LT(WLT)150-6A/5.5	220	6	150	5.5/4	1450	11.8	380	85	0.83
LT(WLT)150-6/7.5	250	6	150	7.5/4	1450	15.6	380	87	0.84
LT(WLT)200-8A/11	300	8	200	11/4	1450	21.0	380	78	0.89
LT(WLT)200-8/15	350	8	200	15/4	1450	28.4	380	78	0.89

Hydraulic Performance Curves

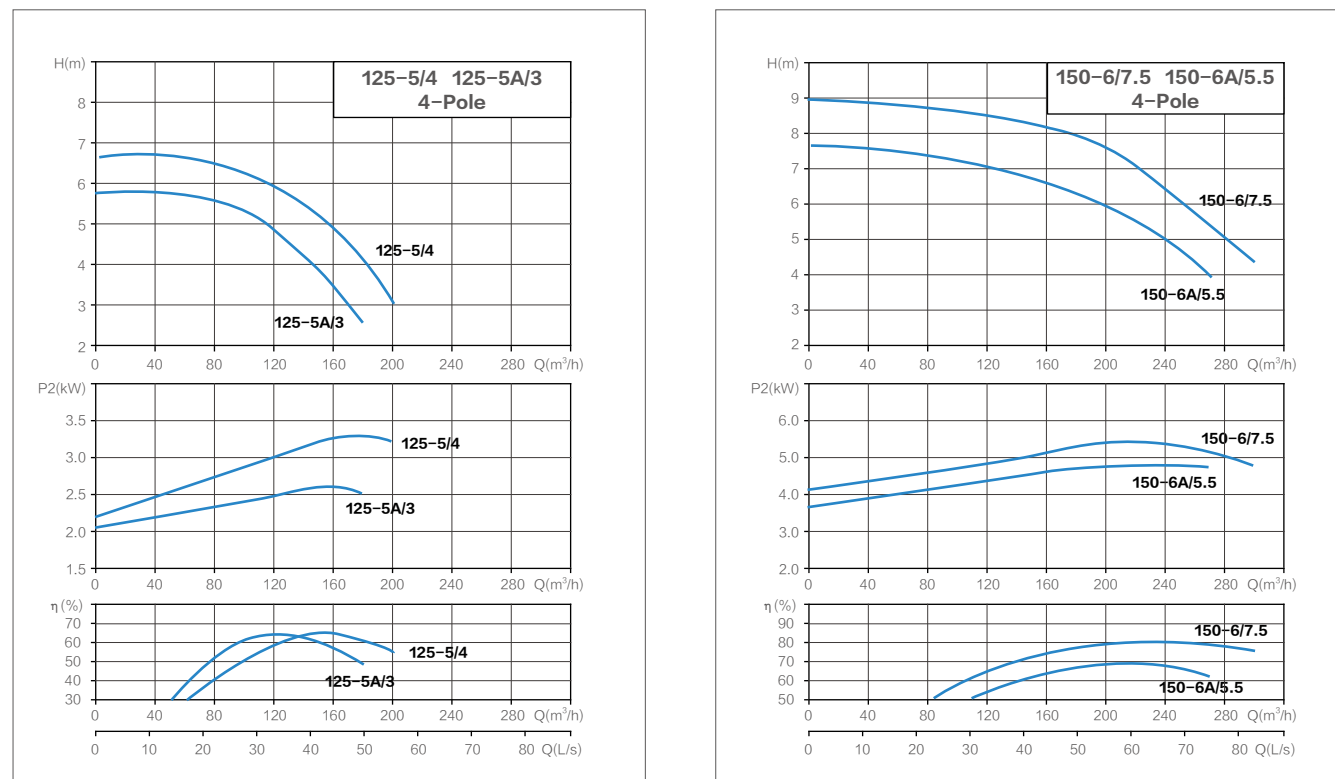
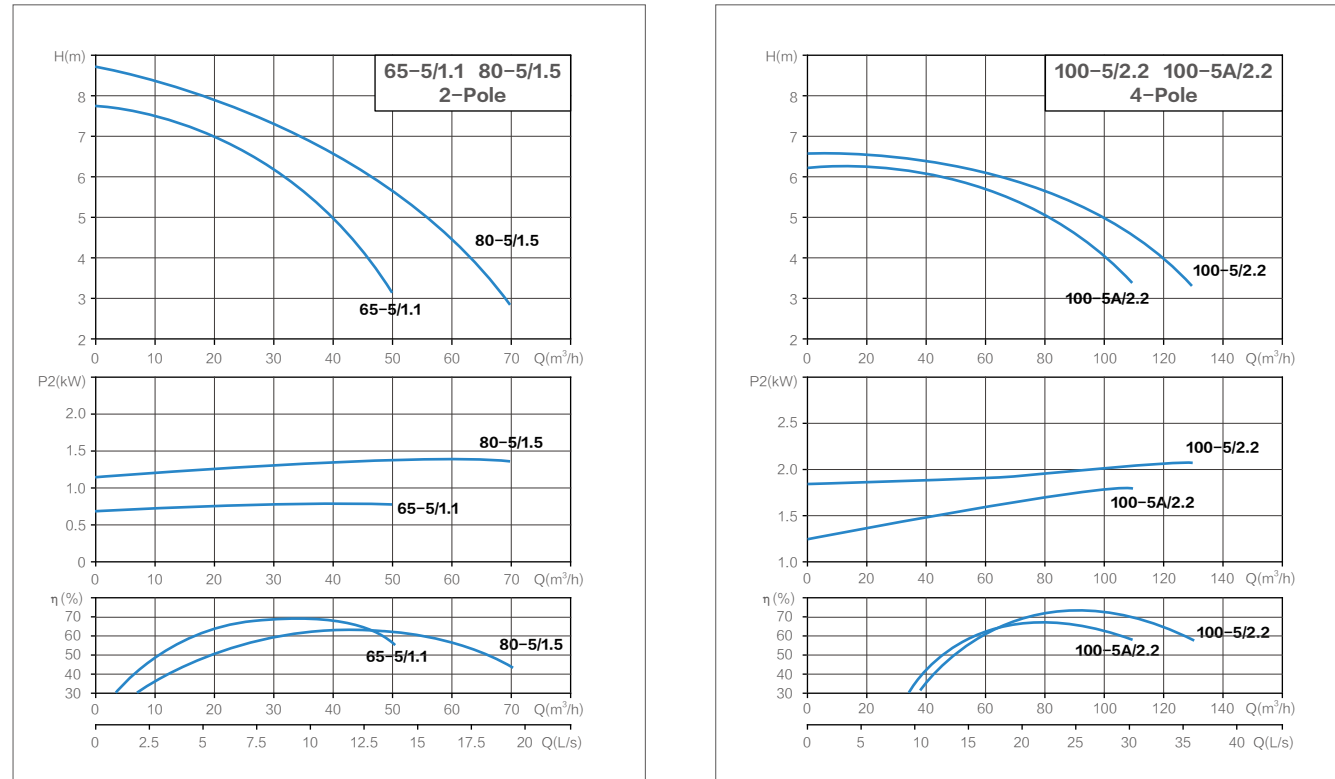

Hydraulic Performance Curves

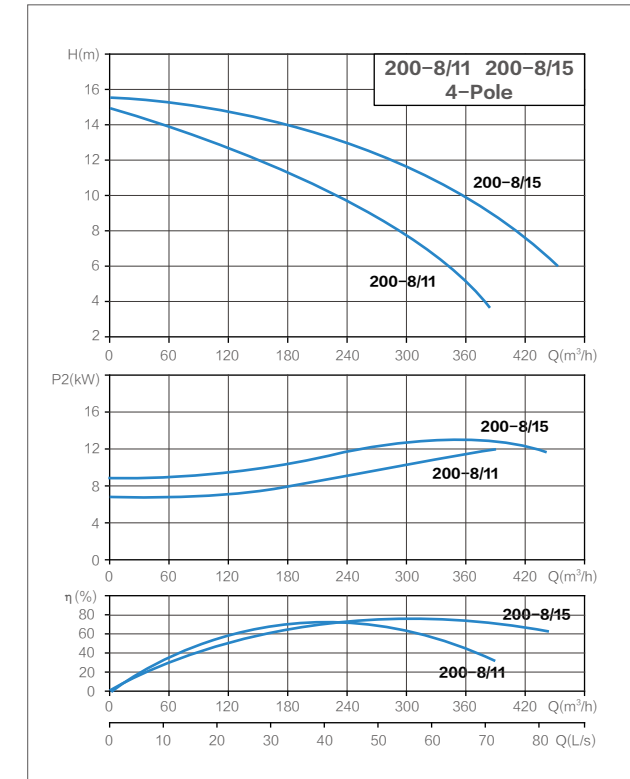

Dimensional Drawing

LT Vertical Cooling Tower Pump

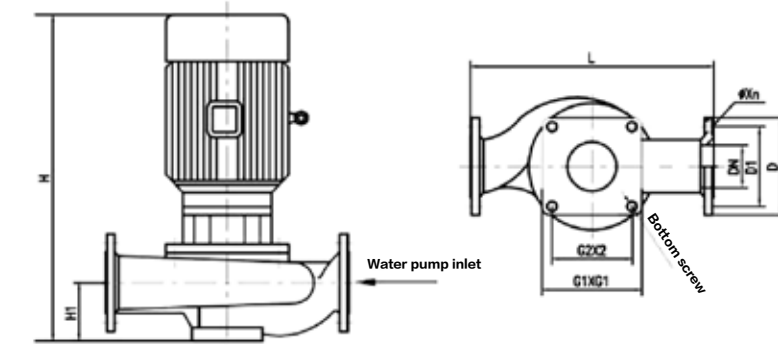

DN	D	D1	L	ΦXn	G1xG1	G2xG2	Bottom screw	H	H1
50	154	120	290	14x4	100x290	80x268	M8x4	337	80
65	160	130	345	14x4	-	-	-	402	105
80	190	150	390	16x4	-	-	-	500	112
100	210	170	475	18x4	-	-	-	600	140
125	235	200	560	18x8	240x240	200x200	M16x4	640	175
150	265	225	720	18x8	300x300	260x260	M16x4	780	208
200	370	320	830	18x8	300x370	260x320	M16x4	960	230

Dimensional Drawing
WLT Horizontal Cooling Tower Pump

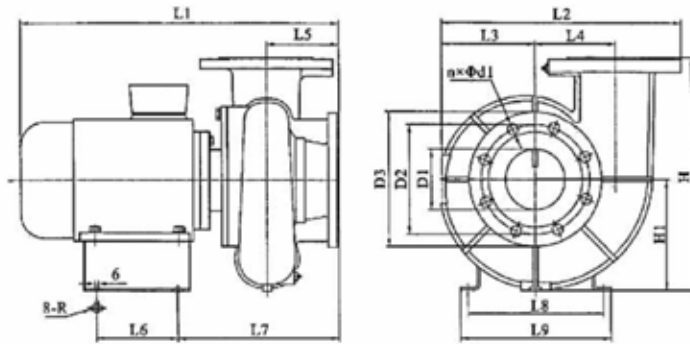

Model	Overall Dimensions					Installation Dimensions							Inlet and outlet flange dimensions					Weight kg
	L1	H	H1	L2	L3	L7	L9	L5	L4	L8	L6	R	D1	D2	D3	n	d1	
WLT65-5-1.1/2	439	242	118	285	107	255	227	104	90	198	101	5	65	145	185	4	18	37
WLT80-5-1.5/2	488	273	133	305	115	260	230	115	95	195	115	6	80	160	200	8	18	60
WLT100-5-2.2/4	562	378	180	400	155	305	254	128	140	224	133	6	100	180	220	8	18	60
WLT125-5A-3/4	577	415	212	450	175	325	250	135	155	223	135	6	125	210	250	8	18	72.5
WLT125-5-4/4	582	415	212	450	175	325	284	135	155	255	135	6	125	210	250	8	18	83
WLT150-6A-5.5/4	653	470	235	510	195	370	355	155	172	310	135	6	150	240	285	8	22	108
WLT150-6-7.5/4	653	470	235	510	195	370	346	155	172	305	175	6	150	240	285	8	22	117

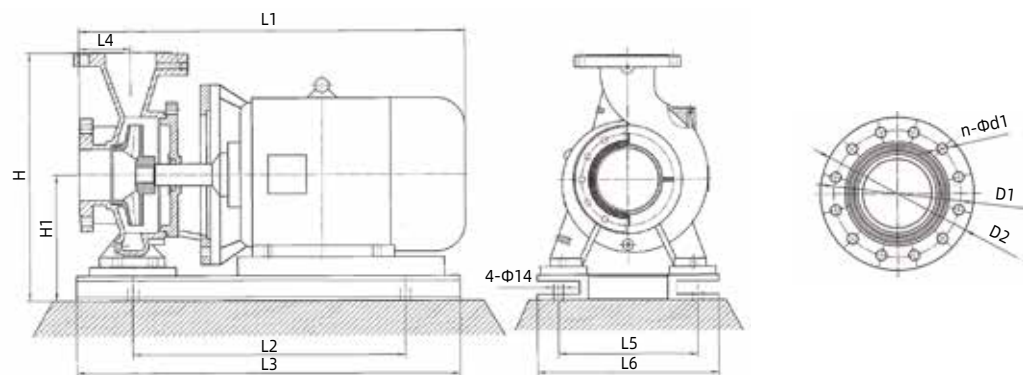

Model	L1	L2	L3	L4	L5	L6	H	H1	D1	D2	d1
WLT200-8-11/4	895	385	685	162	480	520	733	363	Φ295	Φ340	22
WLT200-8-15/4	895	385	685	162	480	520	733	363	Φ295	Φ340	22

IRG/ISW/IRGB ISWB/IHG/IHW

Single Stage Single Suction Pipeline Centrifugal Pump



Private House



Agricultural



Civil use



Industrial use



Main Application

IRG/ISW/IRGB/ISWB/IHG/IHW Single Stage Single Suction Pipeline Centrifugal Pump is a multifunctional product with a wide range of applications, capable of conveying various media including water or industrial liquids, suitable for different temperature, flow rate, and pressure ranges. Its typical applications mainly include the following aspects:

- Thin, clean, non corrosive, non flammable and explosive materials without solid particles or fibers;
- Situations with substances such as softened water, purified water, domestic water supply, clean oil, etc;
- Suitable for industrial and urban water supply and drainage, high-rise pressurized water supply, garden sprinkler irrigation, fire pressurization, long-distance transportation, HVAC refrigeration, and other cold and warm water circulation pressurization and equipment matching;
- Applicable to energy, metallurgy, chemical, textile, papermaking, as well as boiler hot water pressurization transmission and urban heating system circulation in hotels and restaurants.

Used Conditions

- Maximum pressure of the pump system is 1.6Mpa, i.e. pump inlet pressure + pump head \leq 1.6Mpa. (Please specify the system working pressure when ordering. So that the over-flow part and coupling part of the pump are made of cast iron.)
- Applicable medium: volume content of solid insoluble matter doesn't exceed 0.1% of the unit volume, and the particle size is not larger than 0.2mm. (If the medium has fine particles, the wear-resistant mechanical seal must be used, please specify when ordering).
- Ambient temperature not more than 40°C , relative temperature not more than 95°C , altitude not more than 1000m.

Model Implication

IRG 50 - 160 - 3

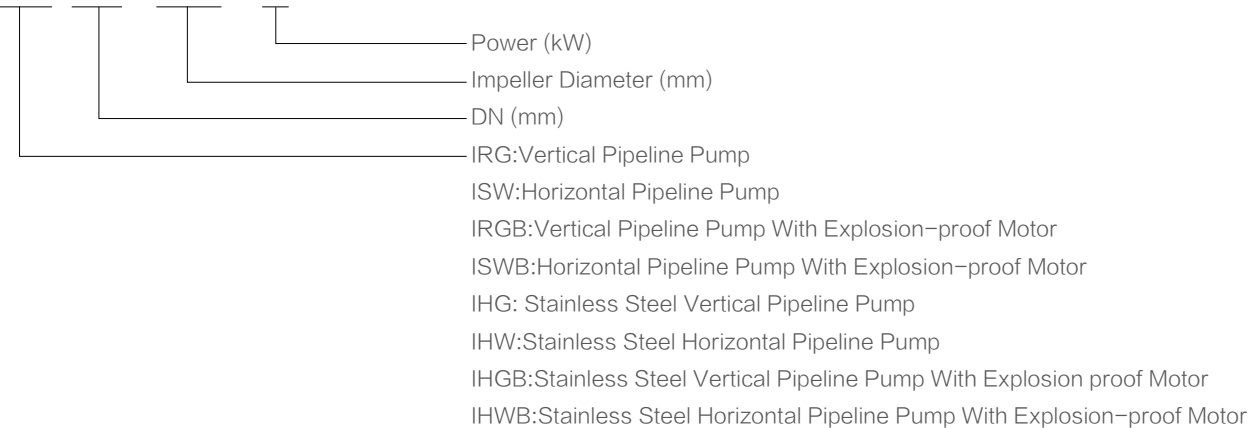

Hydraulic Performance Curves

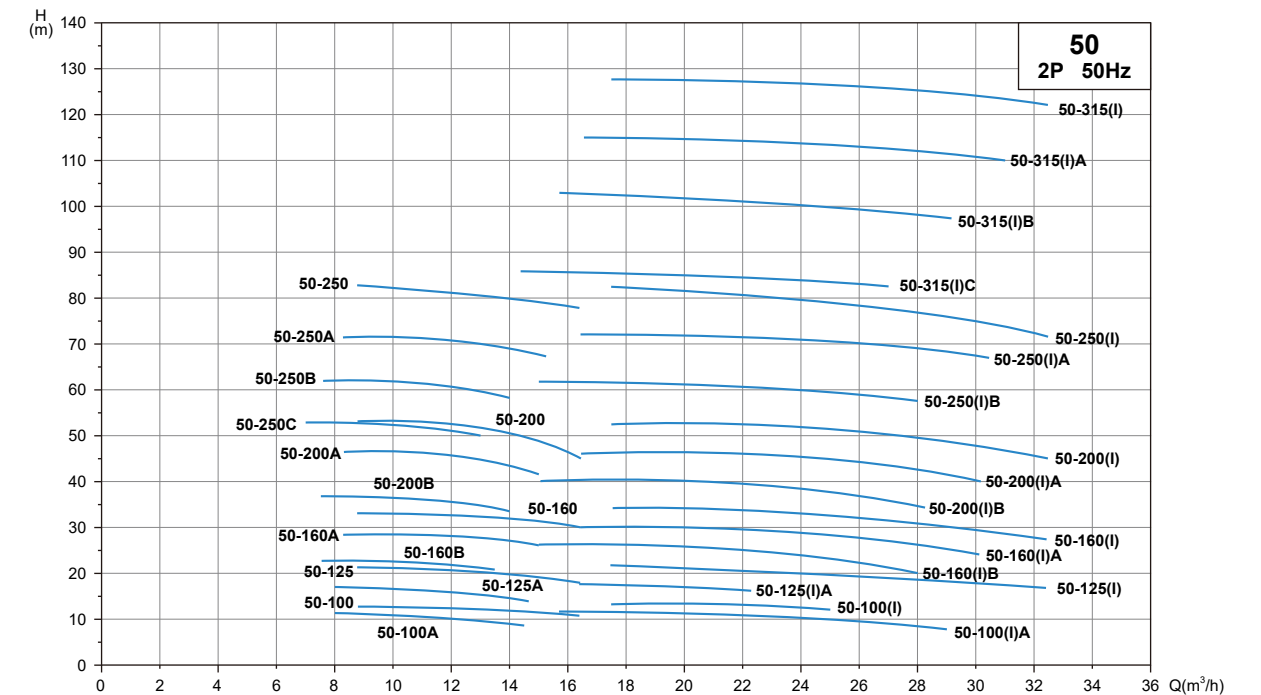
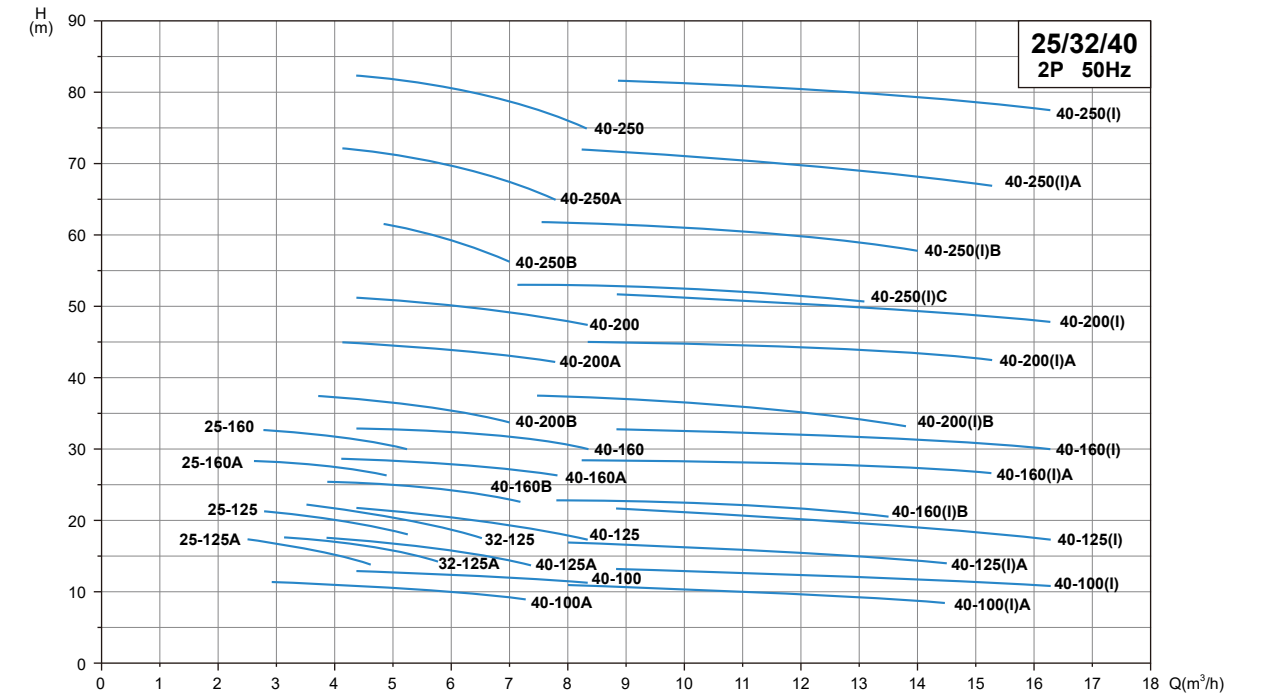

Hydraulic Performance Curves

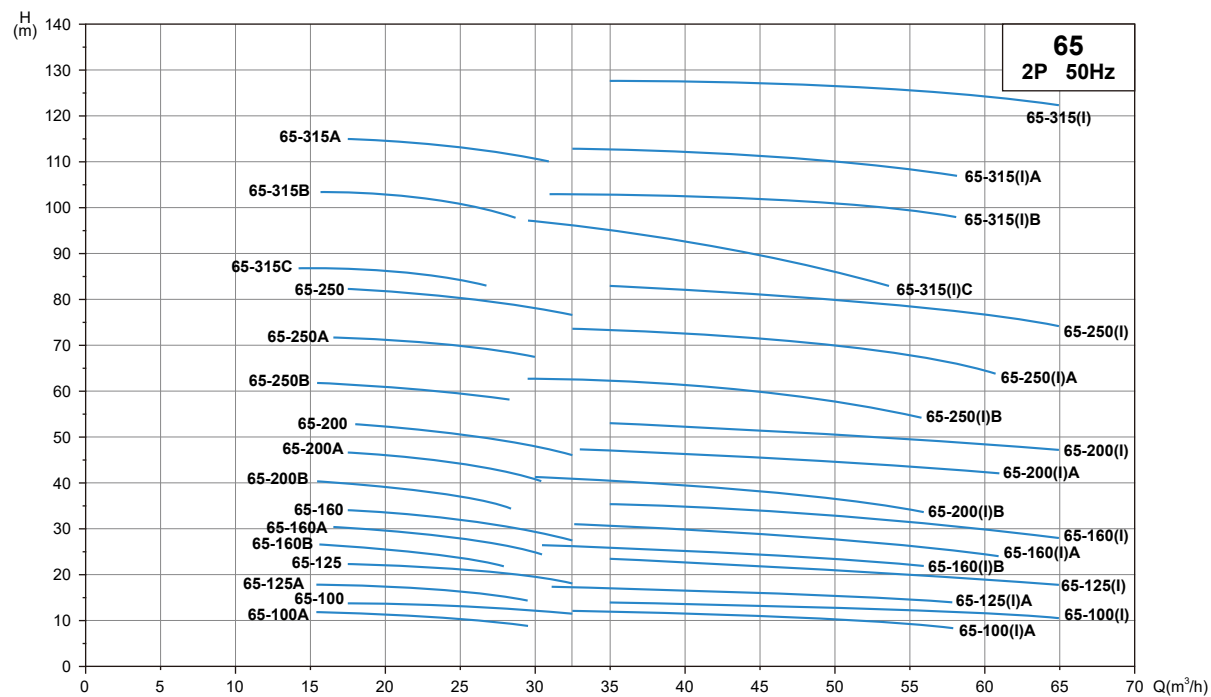

Hydraulic Performance Curves

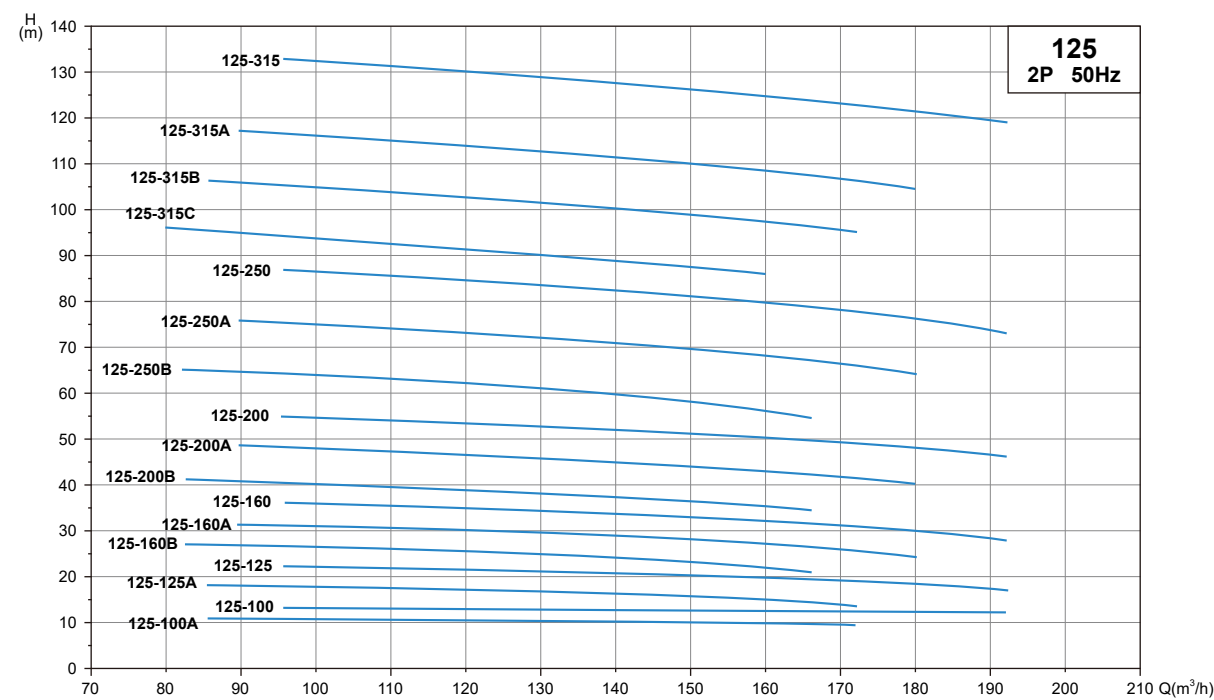
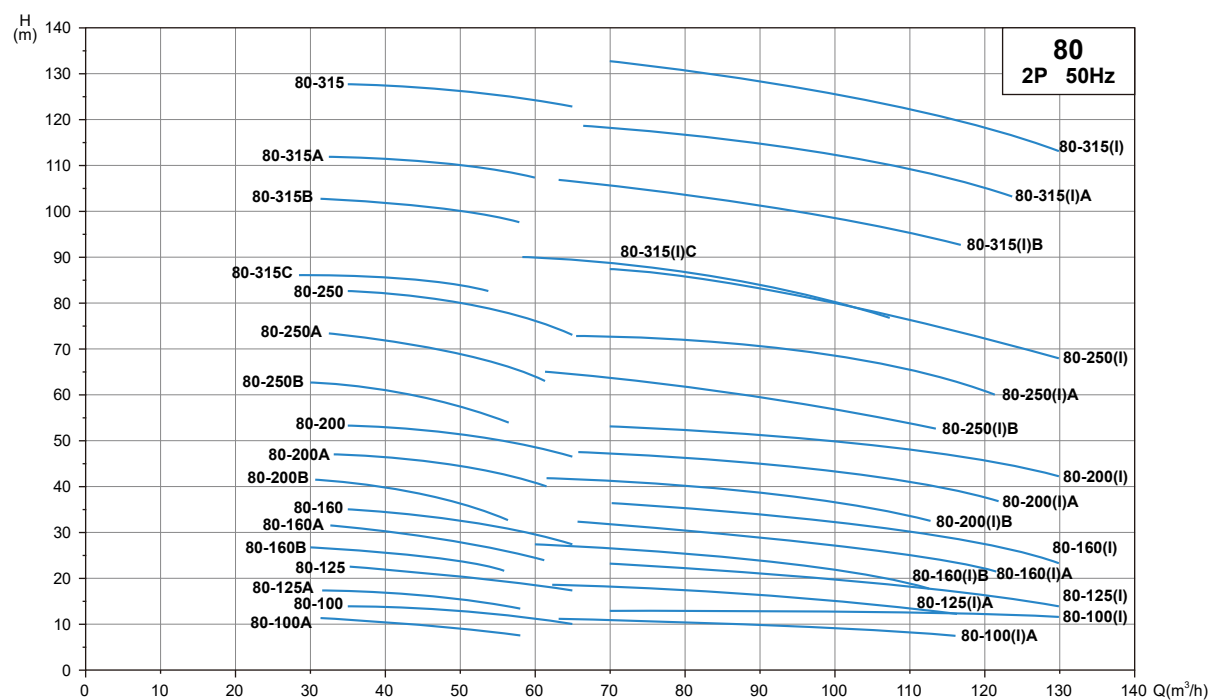
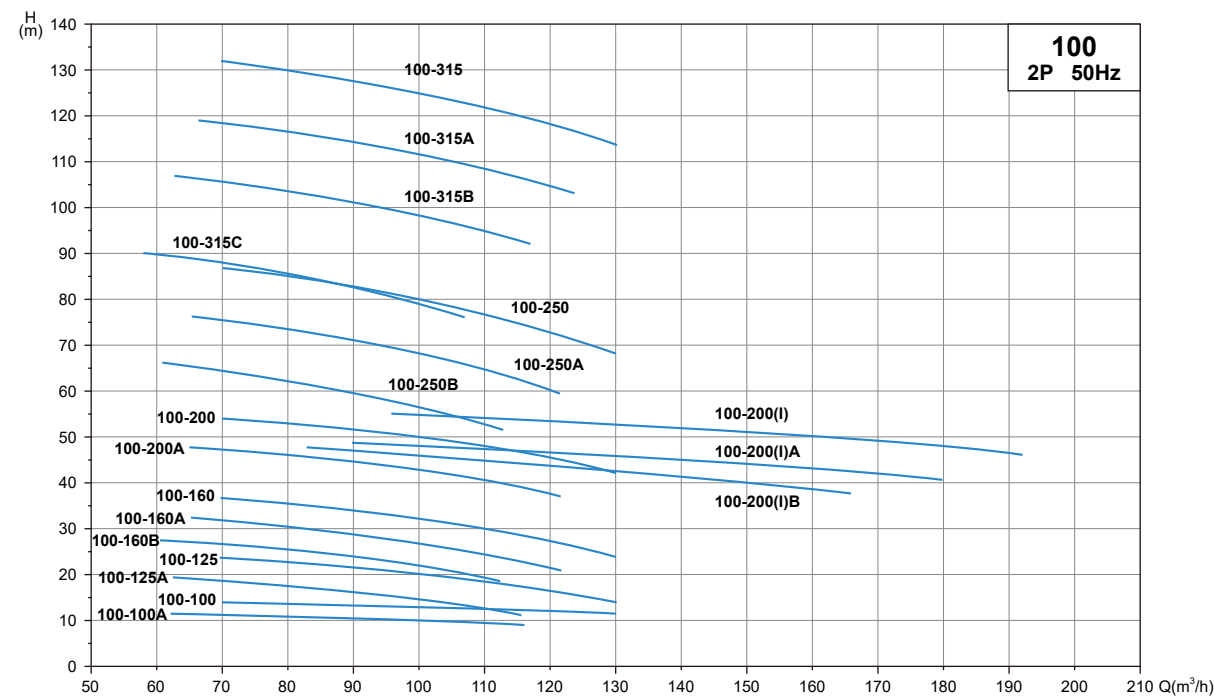

Hydraulic Performance Curves

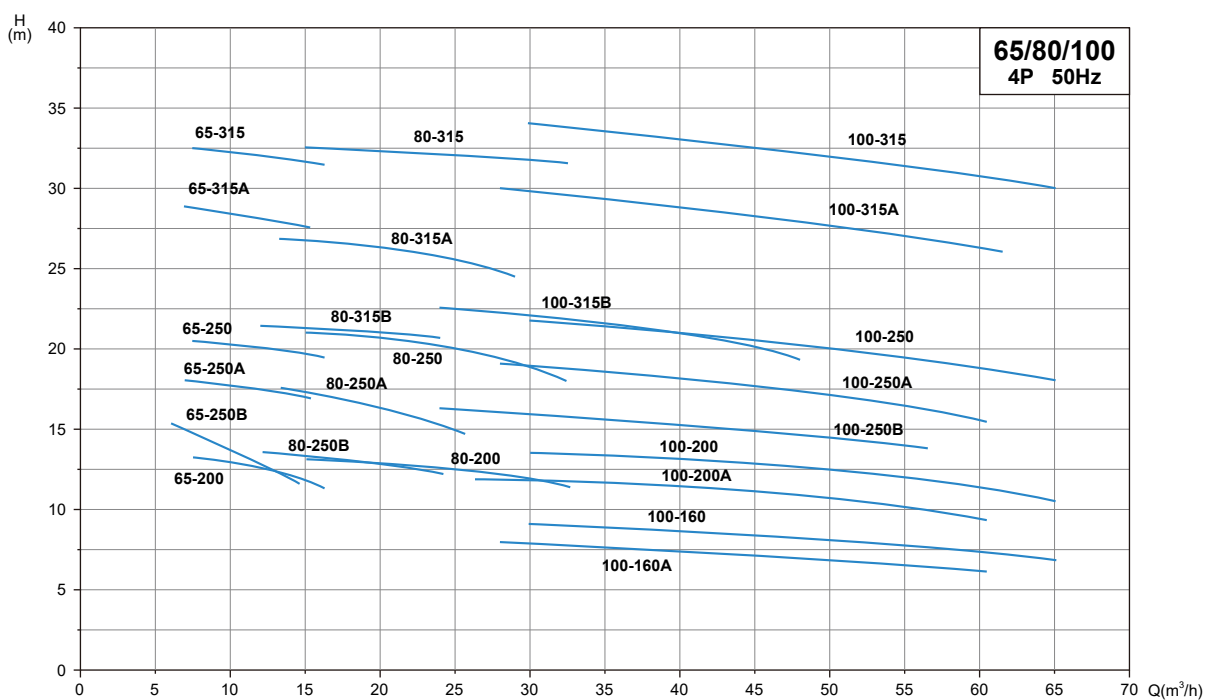
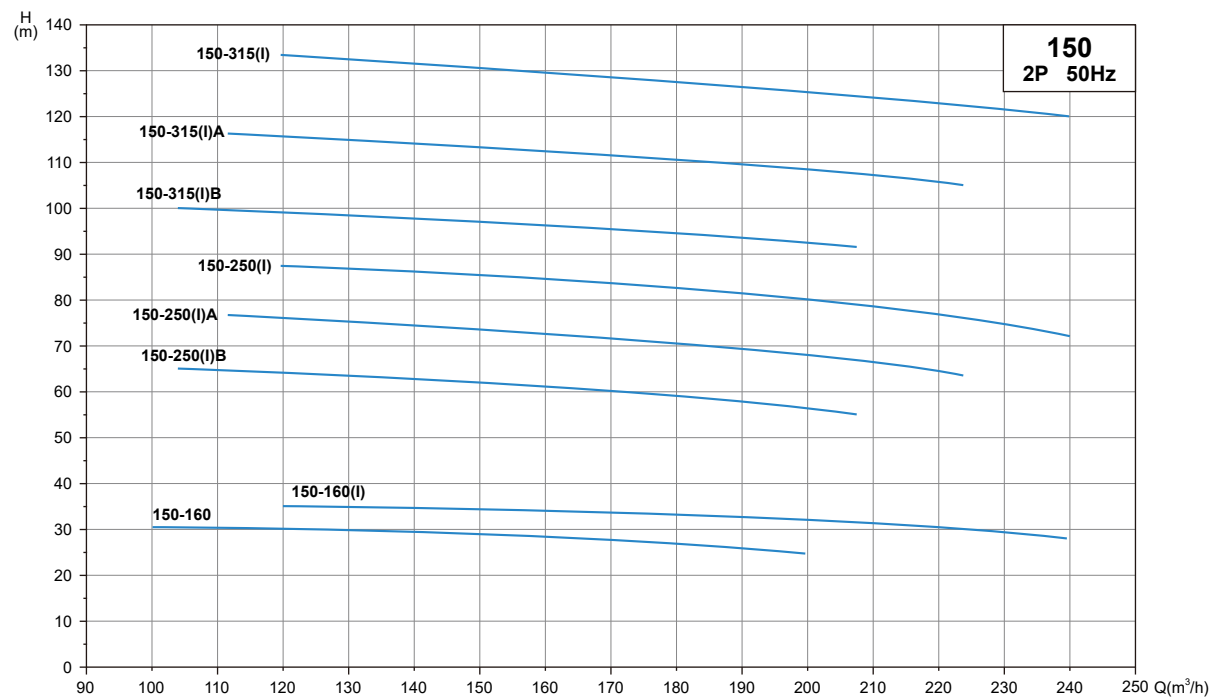

Hydraulic Performance Curves

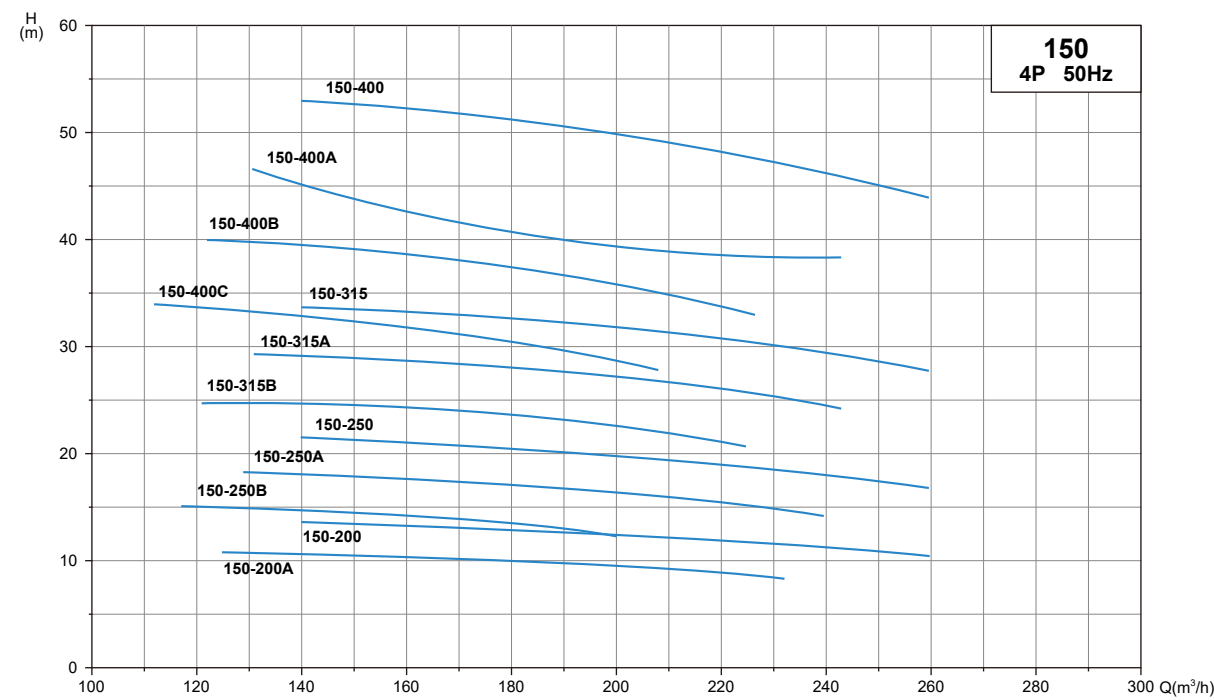
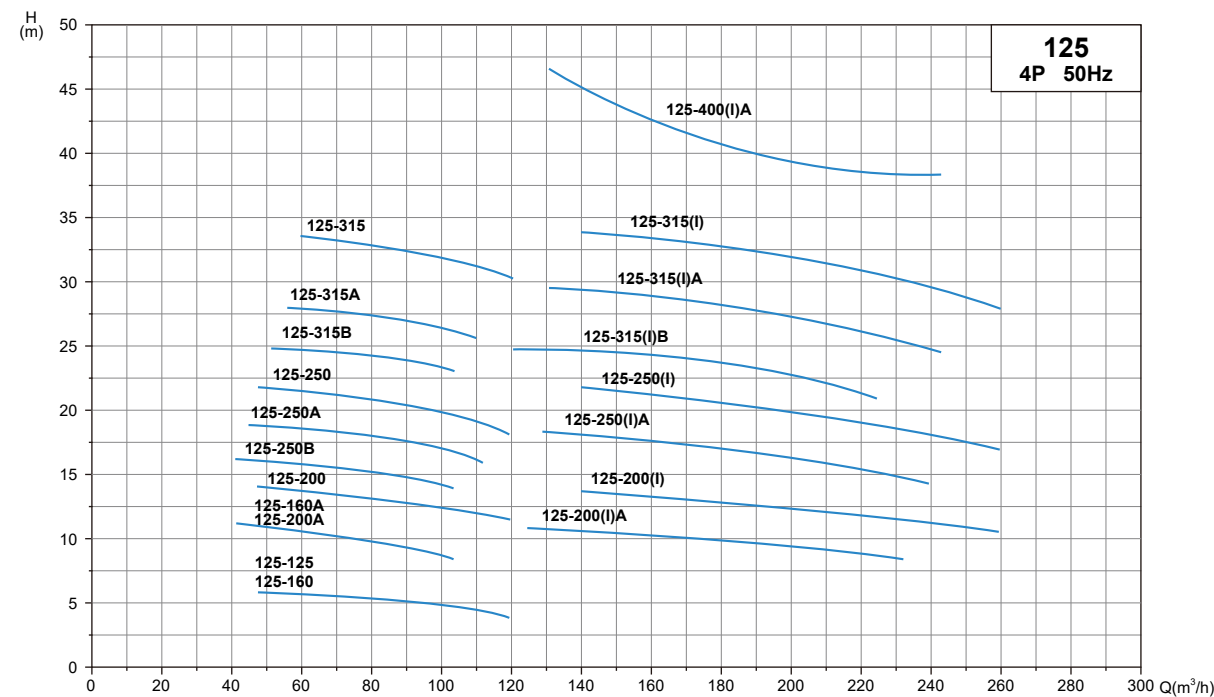

Hydraulic Performance Curves

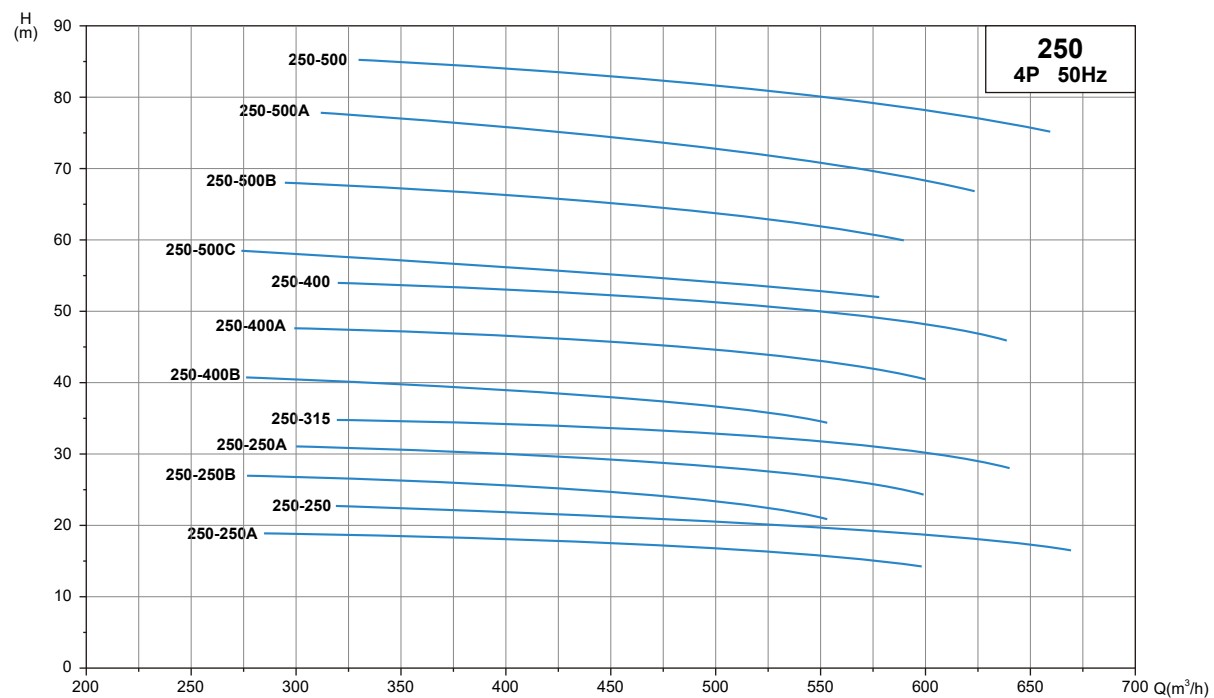
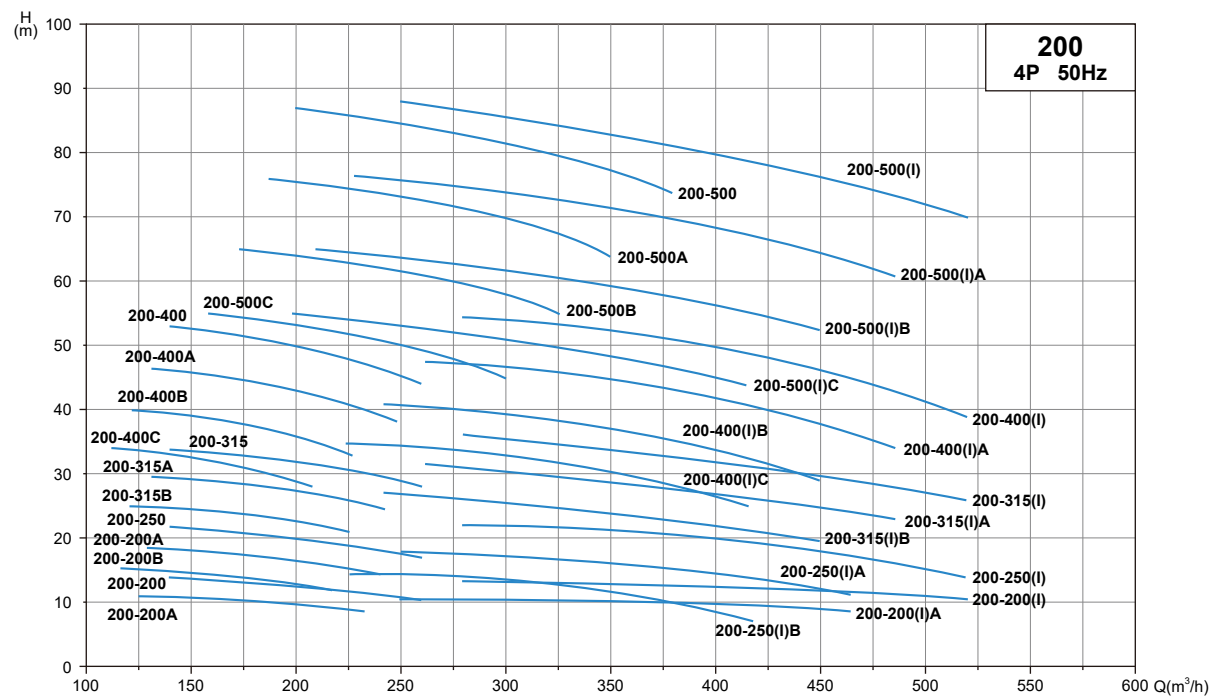

Hydraulic Performance Curves

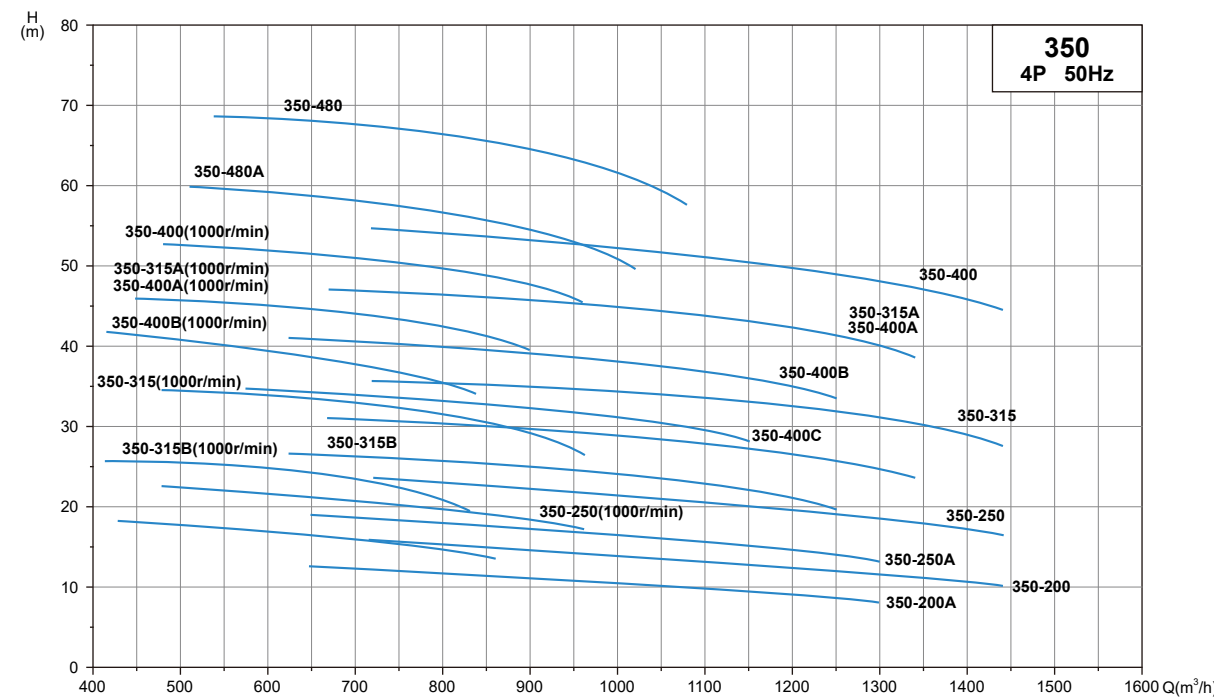
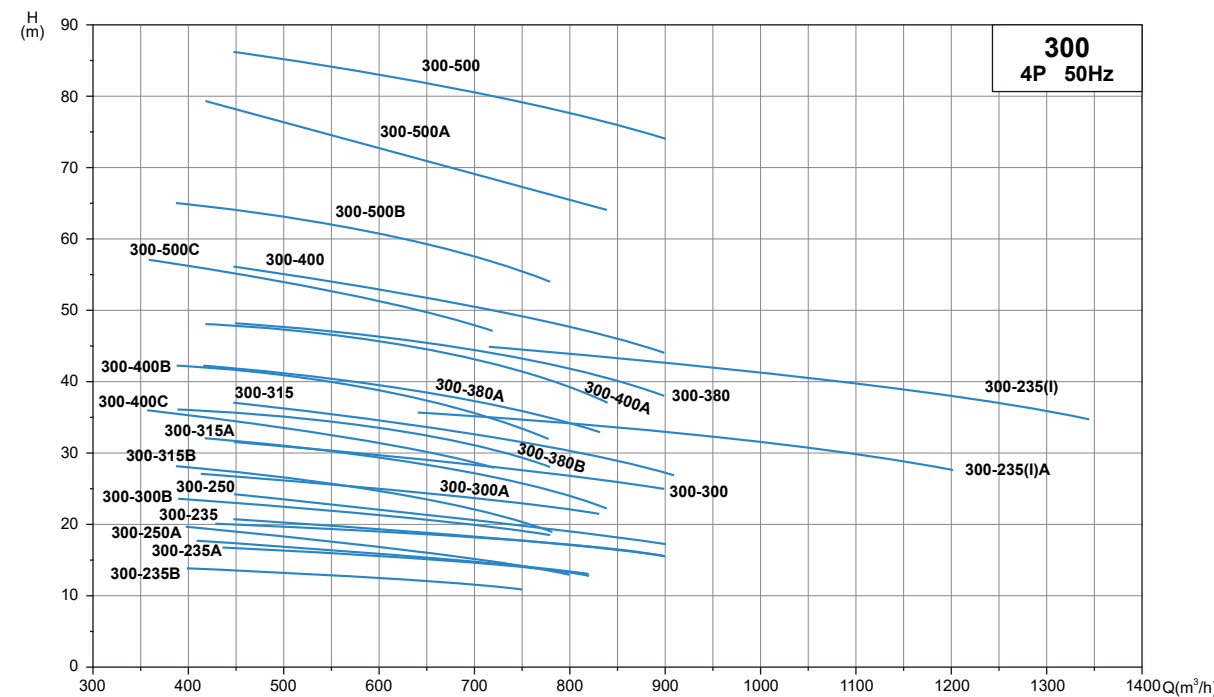

Technical Parameter

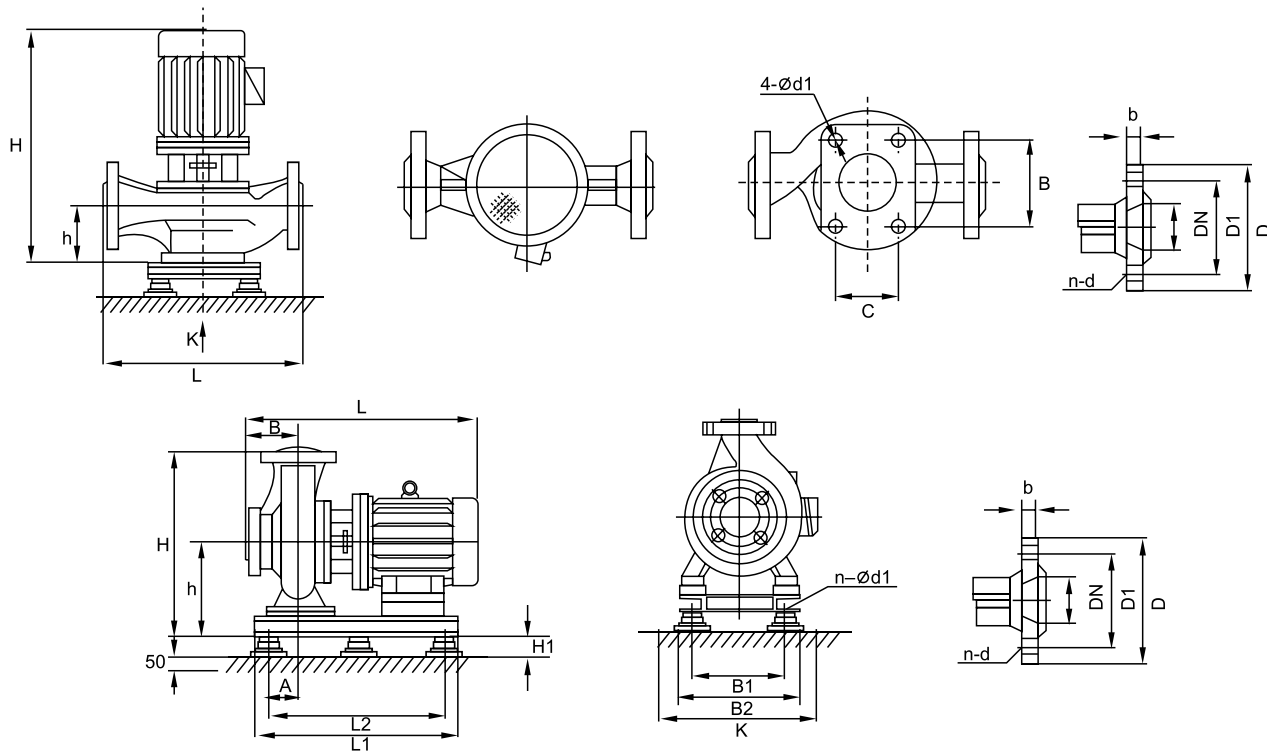

Model	Flow Q		Head (m)	Eta (%)	Speed (r/min)	Power (kW)	NPSH (m)	Vertical Type Installation Size					Horizontal Type Installation Size					Flange Size			Vibration Isolators Spec	H1		
	m³/h	L/s						H	L	h	B	C	H	h	a	L1	L	L2	B1	D			D1	n-d
25-125	2.8	0.78	20.6	28	2900	0.75	2.3	430	265	75	80	50	320	180	90	405	445	210	260	φ115	φ85	4-φ14	SD41-0.5	20
	4	1.11	20	36																				
	5.2	1.44	18	35																				
25-125A	2.5	0.69	17	27	2900	0.75	2.3	430	265	75	80	50	320	180	90	405	445	210	260	φ115	φ85	4-φ14	SD41-0.5	20
	3.6	1	16	35																				
	4.6	1.28	14.4	34																				
25-160	2.8	0.78	33	24	2900	1.5	2.3	455	300	75	115	70	320	180	90	440	470	250	300	φ115	φ85	4-φ14	SD41-0.5	20
	4	1.11	32	32																				
	5.2	1.44	30	33																				
25-160A	2.6	0.72	29	22	2900	1.1	2.3	440	300	75	115	70	320	180	90	440	455	250	300	φ115	φ85	4-φ14	SD41-0.5	20
	3.7	1.03	28	31																				
	4.9	1.36	26	32																				
32-125	3.5	0.97	22	40	2900	0.75	2.3	445	270	75	100	60	320	180	90	440	455	250	310	φ140	φ100	4-φ18	SD41-0.5	20
	5	1.39	20	44																				
	6.5	1.8	18	42																				
32-125A	3.1	0.86	17.6	38	2900	0.75	2.3	445	270	75	100	60	320	180	90	440	455	250	310	φ140	φ100	4-φ18	SD41-0.5	20
	4.5	1.25	16	42																				
	5.8	1.61	14.4	40																				

Technical Parameter

Model	Flow Q		Head (m)	Eta (%)	Speed (r/min)	Power (kW)	NPSH (m)	Vertical Type Installation Size					Horizontal Type Installation Size					Flange Size			Vibration Isolators Spec	H1		
	m³/h	L/s						H	L	h	B	C	H	h	a	L1	L	L2	B1	D			D1	n-d
40-100	4.4	1.22	13.2	48	2900	0.75	2.3	410	290	80	115	60	260	145	95	405	460	260	125	φ150	φ110	4-φ18	SD41-0.5	20
	6.3	1.75	12.5	54																				
	8.3	2.31	11.3	53																				
40-100A	3.9	1.08	10.6	45	2900	0.75	2.3	410	290	80	115	60	260	145	95	405	460	260	125	φ150	φ110	4-φ18	SD41-0.5	20
	5.6	1.56	10	52																				
	7.4	2.06	9	50																				
40-125	4.4	1.22	21	41	2900	1.1	2.3	410	290	80	115	60	305	165	80	405	445	210	260	φ150	φ110	4-φ18	SD41-0.5	20
	6.3	1.75	20	46																				
	8.3	2.31	18	43																				
40-125A	3.9	1.08	17.6	40	2900	0.75	2.3	410	290	80	115	60	305	165	80	405	445	210	260	φ150	φ110	4-φ18	SD41-0.5	20
	5.6	1.56	16	45																				
	7.4	2.06	14.4	41																				
40-160	4.4	1.22	33	35	2900	2.2	2.3	445	320	80	115	70	350	190	85	410	489	257	300	φ150	φ110	4-φ18	SD41-0.5	20
	6.3	1.75	32	40																				
	8.3	2.31	30	40																				
40-160A	4.1	1.44	29	34	2900	1.5	2.3	420	320	80	115	70	350	190	85	410	465	257	300	φ150	φ110	4-φ18	SD41-0.5	20
	5.9	1.64	28	39																				
	7.8	2.17	26.3	39																				
40-160B	3.8	1.06	25.5	34	2900	1.1	2.3	405	320	80	115	70	370	190	85	410	450	257	300	φ150	φ110	4-φ18	SD41-0.5	20
	5.5	1.53	24	38																				
	7.2	2	22.5	37																				
40-200	4.4	1.22	51	26	2900	4	2.3	525	345	85	135	80	405	230	85	490	560	300	350	φ150	φ110	4-φ18	SD41-0.5	20
	6.3	1.75	50	33																				
	8.3	2.31	48	32																				
40-200A	4.1	1.14	45	26	2900	3	2.3	495	345	85	135	80	405	230	85	490	530	300	350	φ150	φ110	4-φ18	SD41-0.5	20
	5.9	1.64	44	31																				
	7.8	2.17	42	30																				
40-200B	3.7	1.08	38	23	2900	2.2	2.3	470	345	85	135	80	395	220	85	455	505	280	310	φ150	φ110	4-φ18	SD41-0.5	20
	5.3	1.47	36	29																				
	7	1.94	34.5	24																				
40-250	4.4	1.22	82	24	2900	7.5	2.3	580	400	100	130	80	455	255	80	540	625	340	380	φ150	φ110	4-φ18	SD41-0.5	20
	6.3	1.75	80	28																				
	8.3	2.31	75	28																				
40-250A	4.1	1.14	72	24	2900	5.5	2.3	580	400	100	130	80	455	255	80	540	625	340	380	φ150	φ110	4-φ18	SD41-0.5	20
	5.9	1.64	70	28																				
	7.8	2.17	65	27																				
40-250B	3.8	1.06	61.5	23	2900	4	2.3	535	400	100	130	80	455	255	80	540	570	340	380	φ150	φ110	4-φ18	SD41-0.5	20
	5.5	1.53	60	27																				
	7	1.94	56	26																				

Technical Parameter

Model	Flow Q		Head (m)	Eta (%)	Speed (r/min)	Power (kW)	NPSH (m)	Vertical Type Installation Size					Horizontal Type Installation Size					Flange Size			Vibration Isolators Spec	H1		
	m³/h	L/s						H	L	h	B	C	H	h	a	L1	L	L2	B1	D			D1	n-d
40-100(I)	8.8	2.44	13.2	55	2900	1.1	2.3	420	300	95	120	70	290	145	80	405	470	210	260	Φ150	Φ110	4-Φ18	SD41-0.5	20
	12.5	3.47	12.5	62				420	300	95	120	70	290	145	80	405	470	210	260	Φ150	Φ110	4-Φ18	SD41-0.5	20
	16.3	4.53	11.3	60				420	300	95	120	70	290	145	80	405	470	210	260	Φ150	Φ110	4-Φ18	SD41-0.5	20
40-100(I)A	8	2.22	10.6	52	2900	0.75	2.3	420	300	95	120	70	290	145	80	405	470	210	260	Φ150	Φ110	4-Φ18	SD41-0.5	20
	11	3.05	10	60				420	300	95	120	70	290	145	80	405	470	210	260	Φ150	Φ110	4-Φ18	SD41-0.5	20
	14.5	4.06	9	56				420	300	95	120	70	290	145	80	405	470	210	260	Φ150	Φ110	4-Φ18	SD41-0.5	20
40-125(I)	8.8	2.44	21.2	49	2900	1.5	2.3	430	305	90	120	70	320	170	90	440	480	250	300	Φ150	Φ110	4-Φ18	SD41-0.5	20
	12.6	3.47	20	58				430	305	90	120	70	320	170	90	440	480	250	300	Φ150	Φ110	4-Φ18	SD41-0.5	20
	16.3	4.53	17.8	57				430	305	90	120	70	320	170	90	440	480	250	300	Φ150	Φ110	4-Φ18	SD41-0.5	20
40-125(I)A	8	2.22	17	47	2900	1.1	2.3	415	305	90	120	70	315	165	90	440	465	210	260	Φ150	Φ110	4-Φ18	SD41-0.5	20
	11	3.05	16	57				415	305	90	120	70	315	165	90	440	465	210	260	Φ150	Φ110	4-Φ18	SD41-0.5	20
	14.5	4.03	14	54				415	305	90	120	70	315	165	90	440	465	210	260	Φ150	Φ110	4-Φ18	SD41-0.5	20
40-160(I)	8.8	2.44	33	45	2900	3	2.3	505	325	100	135	80	380	220	85	485	540	280	320	Φ150	Φ110	4-Φ18	SD41-0.5	20
	12.5	3.47	32	52				505	325	100	135	80	380	220	85	485	540	280	320	Φ150	Φ110	4-Φ18	SD41-0.5	20
	16.3	4.53	30	52				505	325	100	135	80	380	220	85	485	540	280	320	Φ150	Φ110	4-Φ18	SD41-0.5	20
40-160(I)A	8.2	2.28	29	44	2900	2.2	2.3	465	325	100	135	80	380	220	85	455	495	280	310	Φ150	Φ110	4-Φ18	SD41-0.5	20
	11.7	3.25	28	41				465	325	100	135	80	380	220	85	455	495	280	310	Φ150	Φ110	4-Φ18	SD41-0.5	20
	15.2	4.22	26	50				465	325	100	135	80	380	220	85	455	495	280	310	Φ150	Φ110	4-Φ18	SD41-0.5	20
40-160(I)B	7.8	2.38	23	44	2900	1.5	2.3	440	325	100	135	80	380	220	85	455	495	280	310	Φ150	Φ110	4-Φ18	SD41-0.5	20
	10.4	2.89	22	49				440	325	100	135	80	380	220	85	455	495	280	310	Φ150	Φ110	4-Φ18	SD41-0.5	20
	13.5	3.75	20.5	47				440	325	100	135	80	380	220	85	455	495	280	310	Φ150	Φ110	4-Φ18	SD41-0.5	20
40-200(I)	8.8	2.44	51.2	38	2900	5.5	2.3	580	370	95	135	80	400	220	100	535	590	340	340	Φ150	Φ110	4-Φ18	SD41-0.5	20
	12.5	3.47	50	46				580	370	95	135	80	400	220	100	535	590	340	340	Φ150	Φ110	4-Φ18	SD41-0.5	20
	16.3	4.53	48	46				580	370	95	135	80	400	220	100	535	590	340	340	Φ150	Φ110	4-Φ18	SD41-0.5	20
40-200(I)A	8.3	2.31	45	37	2900	4	2.3	530	370	95	135	80	400	220	100	490	580	300	340	Φ150	Φ110	4-Φ18	SD41-0.5	20
	11.7	3.25	44	45				530	370	95	135	80	400	220	100	490	580	300	340	Φ150	Φ110	4-Φ18	SD41-0.5	20
	15.3	4.25	42	45				530	370	95	135	80	400	220	100	490	580	300	340	Φ150	Φ110	4-Φ18	SD41-0.5	20
40-200(I)B	7.5	2.08	37	35	2900	3	2.3	500	370	95	135	80	410	230	100	490	550	300	340	Φ150	Φ110	4-Φ18	SD41-0.5	20
	10.6	2.94	36	44				500	370	95	135	80	410	230	100	490	550	300	340	Φ150	Φ110	4-Φ18	SD41-0.5	20
	13.8	3.83	34	42				500	370	95	135	80	410	230	100	490	550	300	340	Φ150	Φ110	4-Φ18	SD41-0.5	20
40-250(I)	8.8	2.44	81.2	31	2900	11	2.3	675	440	100	160	100	495	270	100	640	735	430	430	Φ150	Φ110	4-Φ18	SD41-0.5	20
	12.5	3.47	80	38				675	440	100	160	100	495	270	100	640	735	430	430	Φ150	Φ110	4-Φ18	SD41-0.5	20
	16.3	4.53	77.5	40				675	440	100	160	100	495	270	100	640	735	430	430	Φ150	Φ110	4-Φ18	SD41-0.5	20
40-250(I)A	8.2	2.28	71	28	2900	7.5	2.3	585	440	100	160	100	480	255	100	540	645	340	380	Φ150	Φ110	4-Φ18	SD41-0.5	20
	11.6	3.22	70	38				585	440	100	160	100	480	255	100	540	645	340	380	Φ150	Φ110	4-Φ18	SD41-0.5	20
	15.2	4.22	68	39				585	440	100	160	100	480	255	100	540	645	340	380	Φ150	Φ110	4-Φ18	SD41-0.5	20
40-250(I)B	7.6	2.11	61.4	28	2900	7.5	2.3	585	440	100	160	100	480	255	100	540	645	340	380	Φ150	Φ110	4-Φ18	SD41-0.5	20
	10.8	3	60	37				585	440	100	160	100	480	255	100	540	645	340	380	Φ150	Φ110	4-Φ18	SD41-0.5	20
	14	3.89	58	37				585	440	100	160	100	480	255	100	540	645	340	380	Φ150	Φ110	4-Φ18	SD41-0.5	20

Technical Parameter

Model	Flow Q		Head (m)	Eta (%)	Speed (r/min)	Power (kW)	NPSH (m)	Vertical Type Installation Size					Horizontal Type Installation Size					Flange Size			Vibration Isolators Spec	H1		
	m³/h	L/s						H	L	h	B	C	H	h	a	L1	L	L2	B1	D			D1	n-d
40-250(I)C	7.1	1.97	53.2	26	2900	5.5	2.3	585	440	100	160	100	480	255	100	540	645	340	380	Φ150	Φ110	4-Φ18	SD41-0.5	20
	10	2.78	52	36				585	440	100	160	100	480	255	100	540	645	340	380	Φ150	Φ110	4-Φ18	SD41-0.5	20
	13.1	3.64	50.4	35				585	440	100	160	100	480	255	100	540	645	340	380	Φ150	Φ110	4-Φ18	SD41-0.5	20
50-100	8.8	2.44	13.6	55	2900	1.1	2.3	420	300	95	120	65	310	167	80	405	470	210	260	Φ165	Φ125	4-Φ18	SD41-0.5	20
	12.5	3.47	12.5	62				420	300	95	120	65	310	167	80	405	470	210	260	Φ165	Φ125	4-Φ18	SD41-0.5	20
	16.3	4.53	11.3	60				420	300	95	120	65	310	167	80	405	470	210	260	Φ165	Φ125	4-Φ18	SD41-0.5	20
50-100A	8	2.22	11	52	2900	0.75	2.3	420	300	95	120	65	310	167	80	405	470	210	260	Φ165	Φ125	4-Φ18	SD41-0.5	20
	11	3.05	10	60				420	300	95	120	65	310	167	80	405	470	210	260	Φ165	Φ125	4-Φ18	SD41-0.5	20
	14.5	4.03	9	56				420	300	95	120	65	310	167	80	405	470	210	260	Φ165	Φ125	4-Φ18	SD41-0.5	20
50-125	8.8	2.44	21.5	49	2900	1.5	2.3	430	305	90	115	70	320	170	90	455	480	285	270	Φ165	Φ125	4-Φ18	SD41-0.5	20
	12.5	3.47	20	58				430	305	90	115	70	320	170	90	455	480	285	270	Φ165	Φ125	4-Φ18	SD41-0.5	20
	16.3	4.53	17.8	57				430	305	90	115	70	320	170	90	455	480	285	270	Φ165	Φ125	4-Φ18	SD41-0.5	20
50-125A	8	2.22	17	47	2900	1.1	2.3	415	305	90	115	70	315	170	90	405	465	210	260	Φ165	Φ125	4-Φ18	SD41-0.5	20
	11	3.05	16	57				415	305	90	115	70	315	170	90	405	465	210	260	Φ165	Φ125	4-Φ18	SD41-0.5	20
	14.5	4.03	14	54				415	305	90	115	70	315	170	90	405	465	210	260	Φ165	Φ125	4-Φ18	SD41-0.5	20
50-160	8.8	2.44	33	45	2900	3	2.3	505	325	85	135	85	355	187	85	495	535	310	320	Φ165	Φ125	4-Φ18	SD41-0.5	20
	12.5	3.47	32	52				505	325	85	135	85	355	187	85	495	535	310	320	Φ165	Φ125	4-Φ18	SD41-0.5	20
	16.3	4.53	30	51				505	325	85	135	85	355	187	85	495	535	310	320	Φ165	Φ125	4-Φ18	SD41-0.5	20
50-160A	8.2	2.28	29	44	2900	2.2	2.3	465	325	85	135	85	355	187										

Technical Parameter

Model	Flow Q		Head (m)	Eta (%)	Speed (r/min)	Power kW	NPSH (m)	Vertical Type Installation Size					Horizontal Type Installation Size					Flange Size			Vibration Isolators Spec	H1		
	m³/h	L/s						H	L	h	B	C	H	h	a	L1	L	L2	B1	D			D1	n-d
50-250B	7.6	2.11	61.4	28	2900	7.5	2.3	595	400	100	160	100	480	255	100	540	645	340	380	Φ165	Φ125	4-Φ18	SD41-0.5	20
	10.8	3	60	37																				
	14	3.89	58	37																				
50-250C	7.1	1.97	53.2	26	2900	5.5	2.3	595	400	100	160	100	480	255	100	540	645	340	380	Φ165	Φ125	4-Φ18	SD41-0.5	20
	10	2.78	52	36																				
	13.1	3.64	50.4	35																				
50-100(I)	17.5	4.86	13.7	67	2900	1.5	2.5	440	315	90	160	100	370	210	95	440	510	300	350	Φ165	Φ125	4-Φ18	SD41-0.5	20
	25	6.94	12.5	69																				
	32.5	9.02	10	70																				
50-100(I)A	15.6	4.3	11	65	2900	1.1	2.5	425	315	90	160	100	370	210	95	440	470	250	300	Φ165	Φ125	4-Φ18	SD41-0.5	20
	22.3	6.19	10	67																				
	29	8.1	8.4	68																				
50-125(I)	17.5	4.86	21.5	60	2900	3	2.5	480	370	110	160	100	335	165	95	480	555	303	292	Φ165	Φ125	4-Φ18	SD41-0.5	20
	25	6.94	20	68																				
	32.5	9.03	18	67																				
50-125(I)A	15.6	4.33	17	58	2900	2.2	2.5	480	370	110	160	100	335	165	95	480	515	303	292	Φ165	Φ125	4-Φ18	SD41-0.5	20
	22.3	6.19	16	66																				
	29	8.05	13	68																				
50-160(I)	17.5	4.86	34.4	54	2900	4	2.5	540	355	100	160	100	405	230	80	505	665	280	350	Φ165	Φ125	4-Φ18	SD41-0.5	20
	25	6.94	32	63																				
	32.5	9.03	27.5	60																				
50-160(I)A	16.4	4.56	30	54	2900	4	2.3	540	355	100	160	100	405	230	80	505	665	300	350	Φ165	Φ125	4-Φ18	SD41-0.5	20
	23.4	6.5	28	52																				
	30.4	8.44	24	59																				
50-160(I)B	15	4.17	26	49	2900	3	2.3	510	355	100	160	100	405	230	85	505	640	300	350	Φ165	Φ125	4-Φ18	SD41-0.5	20
	21.6	6	24	58																				
	28	7.78	20.6	54																				
50-200(I)	17.5	4.86	52.7	49	2900	7.5	2.3	595	390	105	160	100	405	220	100	535	640	340	340	Φ165	Φ125	4-Φ18	SD41-0.5	20
	25	6.94	50	58																				
	32.5	9.03	45.5	59																				
50-200(I)A	16.4	4.56	46.4	48	2900	7.5	2.3	595	390	105	160	100	405	220	100	535	640	340	340	Φ165	Φ125	4-Φ18	SD41-0.5	20
	23.5	6.53	44	57																				
	30.5	8.47	40	58																				
50-200(I)B	15.2	4.22	40	45	2900	5.5	2.3	595	390	105	160	100	405	220	100	535	640	340	340	Φ165	Φ125	4-Φ18	SD41-0.5	20
	21.8	6.06	38	55																				
	28.3	7.86	34.5	55																				
50-250(I)	17.5	4.86	82	39	2900	15	2.3	695	475	120	170	115	515	270	105	695	740	430	440	Φ165	Φ125	4-Φ18	SD41-0.5	20
	25	6.94	80	50																				
	32.5	9.03	76.5	52																				

Technical Parameter

Model	Flow Q		Head (m)	Eta (%)	Speed (r/min)	Power kW	NPSH (m)	Vertical Type Installation Size					Horizontal Type Installation Size					Flange Size			Vibration Isolators Spec	H1		
	m³/h	L/s						H	L	h	B	C	H	h	a	L1	L	L2	B1	D			D1	n-d
50-250(I)A	16.4	4.56	71.5	39	2900	11	2.3	695	475	120	170	115	515	270	105	695	740	430	440	Φ165	Φ125	4-Φ18	SD41-0.5	20
	23.4	6.5	70	50																				
	30.5	8.47	67	52																				
50-250(I)B	15	4.17	61	38	2900	11	2.3	695	475	120	170	115	515	270	105	695	740	430	440	Φ165	Φ125	4-Φ18	SD41-0.5	20
	21.6	6	60	49																				
	28	7.78	57.4	54																				
50-315(I)	17.5	4.86	128	30	2900	30	2.5	865	550	130	180	120	565	290	130	740	930	405	460	Φ165	Φ125	4-Φ18	SD41-0.5	20
	25	6.94	125	40																				
	32.5	9.03	122	44																				
50-315(I)A	16.6	4.61	115	30	2900	22	2.5	785	550	130	180	120	565	290	130	740	850	405	460	Φ165	Φ125	4-Φ18	SD41-0.5	20
	23.7	6.58	113	40																				
	31	8.6	110	44																				
50-315(I)B	15.7	4.36	103	30	2900	18.5	2.5	785	550	130	180	120	565	290	130	740	850	405	460	Φ165	Φ125	4-Φ18	SD41-0.5	20
	22.5	6.25	101	39																				
	29.2	8	98	42																				
50-315(I)C	14.4	4	86	38	2900	15	2.5	705	550	130	180	120	565	290	130	740	770	405	460	Φ165	Φ125	4-Φ18	SD41-0.5	20
	20.6	5.72	85	46																				
	26.8	7.44	83	40																				
65-100	17.5	4.86	13.7	67	2900	1.5	2.5	495	400	122	160	100	380	220	95	455	510	280	310	Φ185	Φ145	4-Φ18	SD41-0.5	20
	25	6.94	12.5	69																				
	32.5	9.03	10.5	69																				
65-100A	15.6	4.3	11	65	2900	1.1	2.5	455	400	122	160	100	380	220	95	440	470	250	300	Φ185	Φ145	4-Φ18	SD41-0.5	20
	22.3	6.19	10	67																				
	29	8.1	8.4	68																				
65-125	17.5	4.86	21.5	60	2900	3	2.5	480	345	112	160	100	335	165	85	480	530	303	292	Φ185	Φ145	4-Φ18	SD41-0.5	20
	25	6.94	20	68																				
	32.5	9.03	18	67																				
65-125A	15.6	4.33	17	58	2900	2.2	2.5	480	365	112	160	100	335	165	85	480	505	303	292	Φ185	Φ145	4-Φ18	SD41-0.5	20
	22.3	6.19	16	66																				
	29	8.06	14.4	65																				
65-160	17.5	4.86	34.4	54	2900	4	2.5	540	360	105	160	100	367	187	85	495	575	310	315	Φ185	Φ145	4-Φ18	SD41-0.5	20
	25	6.94	32	63																				
	32.5	9.03	27.5	60																				
65-160A	16.4	4.56	30	54	2900	4	2.5	540	360	105	160	100	405	230	80	505	575	300	350	Φ185	Φ145	4-Φ18	SD41-0.5	20
	23.4	6.5	28	63																				
	30.4	8.44	24	59																				
65-160B	15.1	4.17	26	49	2900	3	2.5	510	360	105	160	100	405	230	80	505	550	300	350	Φ185	Φ145	4-Φ18	SD41-0.5	20
	21.6	6	24	58																				
	28	7.78	20.6	54																				

Technical Parameter

Model	Flow Q		Head (m)	Eta (%)	Speed (r/min)	Power (kW)	NPSH (m)	Vertical Type Installation Size					Horizontal Type Installation Size					Flange Size			Vibration Isolators Spec	H1		
	m³/h	L/s						H	L	h	B	C	H	h	a	L1	L	L2	B1	D			D1	n-d
65-200	17.5	4.86	52.7	49	2900	7.5	2.5	595	385	105	160	100	415	220	100	495	640	305	315	Φ185	Φ145	4-Φ18	SD41-0.5	20
	25	6.94	50	58																				
	32.5	9.03	45.5	59																				
65-200	7.5	2.08	13.2	58	1450	1.1	2.8	475	385	105	160	100	405	220	100	535	405	310	280	Φ185	Φ145	4-Φ18	SD41-0.5	20
	12.5	3.47	12.5																					
	16.3	4.53	11.4																					
65-200A	16.4	4.56	46.4	48	2900	7.5	2.5	595	385	105	160	100	415	220	100	495	640	305	315	Φ185	Φ145	4-Φ18	SD41-0.5	20
	23.6	6.53	44	57																				
	30.5	8.47	40	58																				
65-200B	15.2	4.22	40	45	2900	5.5	2.5	595	385	105	160	100	415	220	100	495	640	305	315	Φ185	Φ145	4-Φ18	SD41-0.5	20
	21.8	6.06	38	55																				
	28.3	7.86	34.5	55																				
65-250	17.5	2.08	20.5	50	2900	2.2	2.8	520	475	120	172	115	480	250	105	695	740	430	440	Φ185	Φ145	4-Φ18	SD41-0.5	20
	25	3.47	20	50																				
	32.5	4.5	19.5	50																				
65-250	7.5	2.08	20.5	50	1450	2.2	2.8	520	485	120	180	120	480	250	105	695	740	430	440	Φ185	Φ145	4-Φ18	SD41-0.5	20
	12.5	3.47	20																					
	16.3	4.5	19.5																					
65-250A	16.4	4.56	71.5	39	2900	11	2.5	695	475	120	172	115	500	270	105	695	740	430	440	Φ185	Φ145	4-Φ18	SD41-0.5	20
	23.4	6.51	70	50																				
	30.5	8.47	67	52																				
65-250A	7	1.94	18	49	1450	1.5	2.8	520	485	120	180	120	480	250	105	695	740	430	440	Φ185	Φ145	4-Φ18	SD41-0.5	20
	11.7	3.25	17.5																					
	15.3	4.3	17																					
65-250B	15	4.17	61	38	2900	11	2.5	695	485	120	180	120	500	270	105	695	740	430	440	Φ185	Φ145	4-Φ18	SD41-0.5	20
	21.6	6	60	49																				
	28	7.78	57.4	54																				
65-250B	6	1.67	15.6	48	1450	1.1	2.8	505	485	120	180	120	480	250	105	695	740	430	440	Φ185	Φ145	4-Φ18	SD41-0.5	20
	11	2.78	15																					
	14	3.9	14.4																					
65-315	7.5	2.08	32.5	41	1450	4	2.8	640	550	135	180	120	555	280	130	740	930	405	460	Φ185	Φ145	4-Φ18	SD41-0.5	20
	12.5	3.47	32																					
	16.3	4.53	31.5																					
65-315A	16.6	4.61	115	32	2900	22	2.5	785	550	130	180	120	565	290	130	740	850	405	460	Φ185	Φ145	4-Φ18	SD41-0.5	20
	23.7	6.58	113	40																				
	31	8.6	110	44																				
65-315A	7	1.94	28.8	41	1450	3	2.8	615	550	135	180	120	555	280	130	740	850	405	460	Φ185	Φ145	4-Φ18	SD41-0.5	20
	11.7	3.25	28																					
	15.3	4.3	27.5																					

Technical Parameter

Model	Flow Q		Head (m)	Eta (%)	Speed (r/min)	Power (kW)	NPSH (m)	Vertical Type Installation Size					Horizontal Type Installation Size					Flange Size			Vibration Isolators Spec	H1		
	m³/h	L/s						H	L	h	B	C	H	h	a	L1	L	L2	B1	D			D1	n-d
65-315B	15.7	4.26	103	30	2900	18.5	2.5	785	550	130	180	120	565	290	130	695	850	430	440	Φ185	Φ145	4-Φ18	SD41-0.5	20
	22.5	6.25	101	39																				
	29.2	8	98	42																				
65-315C	14.4	4	86	28	2900	15	2.5	705	550	130	180	120	565	290	130	740	770	405	460	Φ185	Φ145	4-Φ18	SD41-0.5	20
	20.6	5.72	85	38																				
	26.8	7.44	83	40																				
65-100(I)	35	9.72	13.8	67	2900	3	3	535	400	130	160	100	380	220	95	505	560	300	350	Φ185	Φ145	4-Φ18	SD41-0.5	20
	50	13.9	12.5	73																				
	65	18.1	10	70																				
65-100(I)A	32.3	8.7	11	66	2900	2.2	3	495	400	130	160	100	370	210	95	485	535	280	320	Φ185	Φ145	4-Φ18	SD41-0.5	20
	44.7	12.4	10	72																				
	58	16.1	8	69																				
65-125(I)	35	9.72	22	67	2900	5.5	3	600	405	125	160	100	385	220	105	535	630	340	340	Φ185	Φ145	4-Φ18	SD41-0.5	20
	50	13.9	20	72.5																				
	65	18.1	17	70																				
65-125(I)A	31.3	8.7	17.5	66	2900	4	3	600	405	125	160	100	385	220	105	490	590	300	340	Φ185	Φ145	4-Φ18	SD41-0.5	20
	45	12.5	16	71																				
	58	16.1	13.6	69																				
65-160(I)	35	9.75	35	63	2900	7.5	3	595	405	120	160	100	420	220	100	535	635	340	340	Φ185	Φ145	4-Φ18	SD41-0.5	20
	50	13.9	32	71																				
	65	18.1	28	70																				
65-160(I)A	32.7	9.7	30.6	62	2900	7.5	3	595	405	120	160	100	420	220	100	535	625	340	340	Φ185	Φ145	4-Φ18	SD41-0.5	20
	46.7	13	28	70																				
	61	16.9	24	69																				
65-160(I)B	30.3	8.4	26	60	2900	5.5	3	595	405	120	160	100	420	220	100	535	625	340	340	Φ185	Φ145	4-Φ18	SD41-0.5	20
	43.3	12	24	69																				
	56.3	15.6	21	67																				
65-200(I)	35	9.72	53.5	55	2900	15	3	715	455	135	160	100	455	270	100	640	640	430	430	Φ185	Φ145	4-Φ18	SD41-0.5	20
	50	13.9	50	67																				
	65	18.1	46	68																				
65-200(I)A	32.8	9.1	47	54	2900	11	3	715	455	135	160	100	455	270	100	640	640	430	430	Φ185	Φ145	4-Φ18	SD41-0.5	20
	47	13.1	44	66																				
	61	16.9	40	67																				
65-200(I)B	30.5	8.5	40.6	52	2900	7.5	3	715	455	135	160	100	440	255	100	540	630	340	380	Φ185	Φ145	4-Φ18	SD41-0.5	20
	43.5	12.1	38	65																				
	56.6	15.7	33.4	65																				
65-250(I)	35	9.72	83	52	2900	22	3	785	485	130	180	120	510	270	125	740	845	405	460	Φ185	Φ145	4-Φ18	SD41-0.5	20
	50	13.9	80	59																				
	65	18.1	72	60																				

Technical Parameter

Model	Flow Q		Head (m)	Eta (%)	Speed (r/min)	Power (kW)	NPSH (m)	Vertical Type Installation Size					Horizontal Type Installation Size					Flange Size			Vibration Isolators Spec	H1		
	m³/h	L/s						H	L	h	B	C	H	h	a	L1	L	L2	B1	D			D1	n-d
65-250(I)A	32.5	9	73	52	2900	18.5	3	785	485	130	180	120	510	270	125	740	810	405	460	Φ185	Φ145	4-Φ18	SD41-0.5	20
	46.7	13	70	59				870	585	135	220	160	620	315	140	795	935	460	450	Φ185	Φ145	4-Φ18	SD41-0.5	20
	61	16.5	63	60				870	585	135	220	160	620	315	140	795	935	460	450	Φ185	Φ145	4-Φ18	SD41-0.5	20
65-250(I)B	30	8.3	62	50	2900	15	3	705	485	130	180	120	510	270	125	740	765	430	440	Φ185	Φ145	4-Φ18	SD41-0.5	20
	43.3	12	60	58				870	585	135	220	160	620	315	140	795	935	460	450	Φ185	Φ145	4-Φ18	SD41-0.5	20
	56	15.6	54	58				870	585	135	220	160	620	315	140	795	935	460	450	Φ185	Φ145	4-Φ18	SD41-0.5	20
65-315(I)	35	9.72	128	44	2900	37	3	870	585	135	220	160	620	315	140	795	935	460	450	Φ185	Φ145	4-Φ18	SD41-0.5	20
	50	13.9	125	54				870	585	135	220	160	620	315	140	795	935	460	450	Φ185	Φ145	4-Φ18	SD41-0.5	20
	65	18.1	121	57				870	585	135	220	160	620	315	140	795	935	460	450	Φ185	Φ145	4-Φ18	SD41-0.5	20
65-315(I)A	32.3	9	112.6	43	2900	30	3	870	585	135	220	160	620	315	140	795	935	460	450	Φ185	Φ145	4-Φ18	SD41-0.5	20
	46.5	12.9	110	54				870	585	135	220	160	620	315	140	795	935	460	450	Φ185	Φ145	4-Φ18	SD41-0.5	20
	58	16.8	106.4	57				870	585	135	220	160	620	315	140	795	935	460	450	Φ185	Φ145	4-Φ18	SD41-0.5	20
65-315(I)B	31	8.6	102.5	41	2900	30	3	870	585	135	220	160	620	315	140	795	935	460	450	Φ185	Φ145	4-Φ18	SD41-0.5	20
	44.5	12.4	100	53				870	585	135	220	160	620	315	140	795	935	460	450	Φ185	Φ145	4-Φ18	SD41-0.5	20
	58	16.1	98	55				870	585	135	220	160	620	315	140	795	935	460	450	Φ185	Φ145	4-Φ18	SD41-0.5	20
65-315(I)C	29	8	98	38	2900	22	3	710	585	135	220	160	620	315	140	740	770	405	460	Φ185	Φ145	4-Φ18	SD41-0.5	20
	41	11.4	85	50				710	585	135	220	160	620	315	140	740	770	405	460	Φ185	Φ145	4-Φ18	SD41-0.5	20
	53.6	14.9	83	52				710	585	135	220	160	620	315	140	740	770	405	460	Φ185	Φ145	4-Φ18	SD41-0.5	20
80-100	35	9.72	13.8	67	2900	3	3	535	400	125	160	100	380	220	95	505	560	300	350	Φ200	Φ160	8-Φ18	SD41-0.5	20
	50	13.9	12.5	73				535	400	125	160	100	380	220	95	505	560	300	350	Φ200	Φ160	8-Φ18	SD41-0.5	20
	65	18.1	10	70				535	400	125	160	100	380	220	95	505	560	300	350	Φ200	Φ160	8-Φ18	SD41-0.5	20
80-100A	31.3	8.7	11	66	2900	2.2	3	495	405	125	160	100	370	210	95	485	535	280	320	Φ200	Φ160	8-Φ18	SD41-0.5	20
	44.7	12.4	10	72				495	405	125	160	100	370	210	95	485	535	280	320	Φ200	Φ160	8-Φ18	SD41-0.5	20
	58	16.1	8	69				495	405	125	160	100	370	210	95	485	535	280	320	Φ200	Φ160	8-Φ18	SD41-0.5	20
80-125	35	9.72	22	67	2900	5.5	3	600	405	125	160	100	385	220	105	535	630	340	340	Φ200	Φ160	8-Φ18	SD41-0.5	20
	50	13.9	20	72.5				600	405	125	160	100	385	220	105	535	630	340	340	Φ200	Φ160	8-Φ18	SD41-0.5	20
	65	18.1	17	70				600	405	125	160	100	385	220	105	535	630	340	340	Φ200	Φ160	8-Φ18	SD41-0.5	20
80-125A	31.3	8.7	17.5	66	2900	4	3	600	405	125	160	100	385	220	105	490	590	300	340	Φ200	Φ160	8-Φ18	SD41-0.5	20
	45	12.5	16	71				600	405	125	160	100	385	220	105	490	590	300	340	Φ200	Φ160	8-Φ18	SD41-0.5	20
	58	16.1	13.6	69				600	405	125	160	100	385	220	105	490	590	300	340	Φ200	Φ160	8-Φ18	SD41-0.5	20
80-160	35	9.72	35	63	2900	7.5	3	595	405	130	160	100	420	220	100	500	635	315	345	Φ200	Φ160	8-Φ18	SD41-0.5	20
	50	13.9	32	71				595	405	130	160	100	420	220	100	500	635	315	345	Φ200	Φ160	8-Φ18	SD41-0.5	20
	65	18.1	28	70				595	405	130	160	100	420	220	100	500	635	315	345	Φ200	Φ160	8-Φ18	SD41-0.5	20
80-160A	32.7	9.1	30.6	62	2900	7.5	3	595	405	130	160	100	420	220	100	500	625	315	345	Φ200	Φ160	8-Φ18	SD41-0.5	20
	46.7	13	28	70				595	405	130	160	100	420	220	100	500	625	315	345	Φ200	Φ160	8-Φ18	SD41-0.5	20
	61	16.9	24	69				595	405	130	160	100	420	220	100	500	625	315	345	Φ200	Φ160	8-Φ18	SD41-0.5	20
80-160B	30.3	8.4	26	60	2900	5.5	3	595	405	130	160	100	420	220	100	535	625	340	340	Φ200	Φ160	8-Φ18	SD41-0.5	20
	43.3	12	24	69				595	405	130	160	100	420	220	100	535	625	340	340	Φ200	Φ160	8-Φ18	SD41-0.5	20
	56.3	15.6	21	67				595	405	130	160	100	420	220	100	535	625	340	340	Φ200	Φ160	8-Φ18	SD41-0.5	20

Technical Parameter

Model	Flow Q		Head (m)	Eta (%)	Speed (r/min)	Power (kW)	NPSH (m)	Vertical Type Installation Size					Horizontal Type Installation Size					Flange Size			Vibration Isolators Spec	H1		
	m³/h	L/s						H	L	h	B	C	H	h	a	L1	L	L2	B1	D			D1	n-d
80-200	35	9.72	53.5	55	2900	15	3	715	430	130	160	100	485	270	105	635	650	430	430	Φ200	Φ160	8-Φ18	SD41-0.5	20
	50	13.9	50	67				715	430	130	160	100	485	270	105	635	650	430	430	Φ200	Φ160	8-Φ18	SD41-0.5	20
	65	18.1	46	68				715	430	130	160	100	485	270	105	635	650	430	430	Φ200	Φ160	8-Φ18	SD41-0.5	20
80-200A	32.8	9.1	47	55	2900	11	3	715	430	130	160	100	485	270	105	635	650	430	430	Φ200	Φ160	8-Φ18	SD41-0.5	20
	47	13.1	44	66				715	430	130	160	100	485	270	105	635	650	430	430	Φ200	Φ160	8-Φ18	SD41-0.5	20
	61	16.9	40	67				715	430	130	160	100	485	270	105	635	650	430	430	Φ200	Φ160	8-Φ18	SD41-0.5	20
80-200B	30.5	8.5	40.6	52	2900	7.5	3	615	430	130	160	100	485	255	105	635	640	340	380	Φ200	Φ160	8-Φ18	SD41-0.5	20
	43.5	12.1	38	65				615	430	130	160	100	485	255	105	635	640	340	380	Φ200	Φ160	8-Φ18	SD41-0.5	20
	56.6	15.7	33.4	65				615	430	130	160	100	485	255	105	635	640	340	380	Φ200	Φ160	8-Φ18	SD41-0.5	20
80-250	35	9.72	83	52	2900	22	3	785	485	130	180	120	505	270	125	675	845	400	455	Φ200	Φ160	8-Φ18	SD41-0.5	20
	50	13.9	80	59				785	485	130	180	120	505	270	125	675	845	400	455	Φ200	Φ160	8-Φ18	SD41-0.5	20
	65	18.1	72	60				785	485	130	180	120	505	270	125	675	845	400	455	Φ200	Φ160	8-Φ18	SD41-0.5	20
80-250	15	4.17	21	60	1450	3	2.8	605	485	130	180	120	490	250	125	975	845	640	430	Φ200	Φ160	8-Φ18	SD41-0.5	20

Technical Parameter

Model	Flow Q		Head (m)	Eta (%)	Speed (r/min)	Power (kW)	NPSH (m)	Vertical Type Installation Size					Horizontal Type Installation Size					Flange Size			Vibration Isolators Spec	H1		
	m³/h	L/s						H	L	h	B	C	H	h	a	L1	L	L2	B1	D			D1	n-d
80-315B	31	8.6	102.5	39	2900	30	3	87	585	135	220	160	620	315	140	795	935	460	450	Φ200	Φ160	8-Φ18	SD41-0.5	20
	44.5	12.4	100	51																				
	58	16.1	98	51																				
80-315B	12	3.38	21.4	49	1450	3	2.8	615	485	130	180	120	510	270	125	975	615	640	430	Φ200	Φ160	8-Φ18	SD41-0.5	20
	20	5.56	21	49																				
	24	6.67	20.6	49																				
80-315C	29	8.1	87	51	2900	22	3	710	585	135	220	120	620	315	140	740	770	405	460	Φ200	Φ160	8-Φ18	SD41-0.5	20
	41	11.4	85	51																				
	53.6	14.9	83	51																				
80-100(I)	70	19.4	13.6	66	2900	5.5	4.5	615	460	140	180	120	425	220	115	535	665	340	340	Φ200	Φ160	8-Φ18	SD41-0.5	20
	100	27.8	12.5	74																				
	130	36.1	11	75																				
80-100(I)A	62.6	17.4	11	70	2900	4	4.5	575	460	140	180	120	425	220	115	490	620	300	340	Φ200	Φ160	8-Φ18	SD41-0.5	20
	89	24.7	10	76																				
	116	32.2	8.8	65																				
80-125(I)	70	19.4	23.5	68	2900	11	4.5	715	455	140	180	120	475	270	120	640	765	430	430	Φ200	Φ160	8-Φ18	SD41-0.5	20
	100	27.8	20	72																				
	130	36.1	14	64																				
80-125(I)A	62.6	17.4	19	65	2900	7.5	4.5	615	455	140	180	120	460	255	120	540	670	340	380	Φ200	Φ160	8-Φ18	SD41-0.5	20
	89	24.7	16	72																				
	116	32.2	11	64																				
80-160(I)	70	19.4	36.5	65	2900	15	4.5	730	510	155	160	100	525	270	100	640	740	430	430	Φ200	Φ160	8-Φ18	SD41-0.5	20
	100	27.8	32	74																				
	130	36.1	24	73																				
80-160(I)A	65.4	18.2	32	68	2900	11	4.5	730	510	155	160	100	525	270	100	640	740	430	430	Φ200	Φ160	8-Φ18	SD41-0.5	20
	93.5	26	28	74																				
	121.6	33.8	21	67																				
80-160(I)B	60.6	16.8	27	65	2900	11	4.5	730	510	155	160	100	525	270	100	640	740	430	430	Φ200	Φ160	8-Φ18	SD41-0.5	20
	86.6	24.1	24	72																				
	112.5	32.3	18	64																				
80-200(I)	70	19.4	54	65	2900	22	4.5	790	475	135	180	120	510	270	100	740	740	405	460	Φ200	Φ160	8-Φ18	SD41-0.5	20
	100	27.8	50	74																				
	130	36.1	42	73																				
80-200(I)A	65.4	18.2	47.5	64	2900	18.5	4.5	790	475	135	180	120	510	270	100	695	430	460	440	Φ200	Φ160	8-Φ18	SD41-0.5	20
	93.5	26	44	73																				
	121.6	33.8	37	72																				
80-200(I)B	61	16.9	41	61	2900	15	4.5	710	475	135	180	120	510	270	100	695	430	640	440	Φ200	Φ160	8-Φ18	SD41-0.5	20
	87	24.2	38	71																				
	113	31.4	32	69																				

Technical Parameter

Model	Flow Q		Head (m)	Eta (%)	Speed (r/min)	Power (kW)	NPSH (m)	Vertical Type Installation Size					Horizontal Type Installation Size					Flange Size			Vibration Isolators Spec	H1		
	m³/h	L/s						H	L	h	B	C	H	h	a	L1	L	L2	B1	D			D1	n-d
80-250(I)	70	19.4	87	62	2900	37	4	875	550	140	180	120	565	290	130	795	460	460	450	Φ200	Φ160	8-Φ18	SD41-0.5	20
	100	27.8	80	69																				
	130	36.1	68	68																				
80-250(I)A	65.4	18.2	73	61	2900	30	4	875	550	140	180	120	565	290	130	795	460	640	450	Φ200	Φ160	8-Φ18	SD41-0.5	20
	93.5	26	70	68																				
	121.6	33.8	59.5	67																				
80-250(I)B	61	16.9	65	66	2900	30	4	875	550	140	180	120	565	290	130	795	460	405	450	Φ200	Φ160	8-Φ18	SD41-0.5	20
	87	24.2	60	66																				
	113	31.4	51	66																				
80-315(I)	70	19.4	132	55	2900	75	4	1100	645	160	270	185	670	340	135	920	720	340	460	Φ200	Φ160	8-Φ18	SD41-0.5	20
	100	27.8	125	66																				
	130	36.1	114	67																				
80-315(I)A	66.5	18.5	119	55	2900	55	4	1020	645	160	270	185	670	340	135	850	640	300	400	Φ200	Φ160	8-Φ18	SD41-0.5	20
	95	26.4	113	66																				
	123.6	34.3	103	67																				
80-315(I)B	63	17.5	106.6	52	2900	45	4	940	645	160	270	185	670	340	135	810	670	430	370	Φ200	Φ160	8-Φ18	SD41-0.5	20
	90	25	101	64																				
	117	32.5	92	64																				
80-315(I)C	58	16	90	50	2900	37	4	895	645	160	270	185	645	315	135	795	460	340	450	Φ200	Φ160	8-Φ18	SD41-0.5	20
	82	22.7	85	60																				
	107	29.7	76	61																				
100-100	70	19.4	13.6	66	2900	5.5	4.5	615	460	140	180	120	435	220	100	535	340	338	345	Φ220	Φ185	8-Φ18	SD41-0.5	20
	100	27.7	12.5	76																				
	130	36.1	11	75																				
100-100A	62.6	17.4	11	64	2900	4	4.5	575	460	140	180	120	425	220	115	490	300	430	340	Φ220	Φ185	8-Φ18	SD41-0.5	20
	89	24.7	10	74																				
	116	32.2	8.8	74																				
100-125	70	19.4	23.5	70	2900	11	4.5	715	445	135	180	120	490	270	105	640	430	430	430	Φ220	Φ185	8-Φ18	SD41-0.5	20
	100	27.7	20	76																				
	130	36.1	14	65																				
100-125A	62.6	17.4	19	68	2900	7.5	4.5	615	445	140	180	120	460	255	120	540	670	340	380	Φ220	Φ185	8-Φ18	SD41-0.5	20
	89	24.7	16	74																				
	116	32.2	11	63																				
100-160	70	19.4	36.5	70	2900	15	4.5	730	500	145	180	120	525	270	100	640	740	430	430	Φ220	Φ185	8-Φ18	SD41-0.5	20
	100	27.8	32	76																				
	130	36.1	24	65																				
100-160	30	8.33	9.2	75	1450	2.2	3	575	510	155	160	100	525	270	100	975	740	640	430	Φ220	Φ185	8-Φ18	SD41-0.5	20
	50	13.9	8	75																				
	65	18.1	6.8	75																				

Technical Parameter

Model	Flow Q		Head (m)	Eta (%)	Speed (r/min)	Power (kW)	NPSH (m)	Vertical Type Installation Size					Horizontal Type Installation Size					Flange Size			Vibration Isolators Spec	H1		
	m³/h	L/s						H	L	h	B	C	H	h	a	L1	L	L2	B1	D			D1	n-d
100-160A	65.4	18.5	32	68	2900	11	4.5	730	510	155	160	100	525	270	100	640	740	430	430	Φ220	Φ185	8-Φ18	SD41-0.5	20
	93.5	26	28	74																				
	121.6	33.8	21	67																				
100-160A	28	7.78	8	73	1450	1.5	3	575	510	155	160	100	525	270	100	1000	740	640	430	Φ220	Φ185	8-Φ18	SD41-0.5	20
	46.8	13	7																					
	60.5	16.8	6																					
100-160B	60.6	16.8	27	66	2900	11	4.5	730	510	155	160	100	525	270	100	640	740	430	430	Φ220	Φ185	8-Φ18	SD41-0.5	20
	86.6	24.1	24	72																				
	112.5	31.3	18	64																				
100-200	70	19.4	54	65	2900	22	4	790	475	135	180	125	505	265	100	675	740	400	455	Φ220	Φ185	8-Φ18	SD41-0.5	20
	100	27.8	50	74																				
	130	36.1	42	73																				
100-200	30	8.33	13.5	74	1450	3	3	610	475	135	180	125	505	265	100	975	580	640	430	Φ220	Φ185	8-Φ18	SD41-0.5	20
	50	13.9	12.5																					
	65	18.1	10.5																					
100-200A	65.4	18.2	47.5	64	2900	18.5	4	790	475	135	180	125	505	265	100	685	690	420	435	Φ220	Φ185	8-Φ18	SD41-0.5	20
	93.5	26	44	73																				
	121.6	33.8	37	72																				
100-200A	26.4	7.33	11.9	72	1450	2.2	3	585	475	135	180	125	510	270	100	975	580	430	430	Φ220	Φ185	8-Φ18	SD41-0.5	20
	44.6	13	9.9																					
	60.5	16.8	9.3																					
100-200(I)	96	26.7	55	77	2900	37	5.5	895	570	160	180	120	575	290	130	795	930	460	450	Φ220	Φ185	8-Φ18	SD41-1	20
	160	44.4	50																					
	192	53.3	46																					
100-200(I) A	90	25	48.4	75	2900	30	5.5	895	570	160	180	120	575	290	130	795	930	460	450	Φ220	Φ185	8-Φ18	SD41-1	20
	140	45	44																					
	180	50	40.5																					
100-200(I) B	83	21.7	47.5	73	2900	22	5.5	815	570	160	180	120	575	290	130	740	850	405	460	Φ220	Φ185	8-Φ18	SD41-1	20
	100	38.3	40																					
	166	46.1	37.5																					
100-250	70	19.4	87	62	2900	37	4	875	550	140	160	120	565	290	130	795	930	460	450	Φ220	Φ185	8-Φ18	SD41-0.5	20
	100	27.8	80	69																				
	130	36.1	68	68																				
100-250	30	8.33	21.8	70	1450	5.5	3	690	550	140	180	120	565	290	130	975	685	640	430	Φ220	Φ185	8-Φ18	SD41-0.5	20
	50	13.9	20																					
	65	18.1	18																					
100-250A	65.4	18.2	76	61	2900	30	4	875	550	140	180	120	565	290	130	795	930	460	450	Φ220	Φ185	8-Φ18	SD41-0.5	20
	93.5	26	70	68																				
	121.6	33.8	59.5	67																				

Technical Parameter

Model	Flow Q		Head (m)	Eta (%)	Speed (r/min)	Power (kW)	NPSH (m)	Vertical Type Installation Size					Horizontal Type Installation Size					Flange Size			Vibration Isolators Spec	H1		
	m³/h	L/s						H	L	h	B	C	H	h	a	L1	L	L2	B1	D			D1	n-d
100-250A	28	7.78	19	68	1450	4	3	665	550	140	180	120	565	290	130	975	660	640	430	Φ220	Φ185	8-Φ18	SD41-0.5	20
	46.7	13	17.4																					
	60.5	16.8	15.5																					
100-250B	61	16.9	65.8	59	2900	30	4	875	550	140	180	120	565	290	130	795	930	460	450	Φ220	Φ185	8-Φ18	SD41-0.5	20
	87	27.8	60.5	68																				
	113	31.3	51.4	66																				
100-250B	24	6.67	16.3	65	1450	3	3	640	550	140	180	120	565	290	130	975	635	640	430	Φ220	Φ185	8-Φ18	SD41-0.5	20
	43.5	12.1	15																					
	56.5	15.7	13.8																					
100-315	70	19.4	132	55	2900	75	4	1100	645	160	270	185	670	340	135	1000	1150	800	520	Φ220	Φ185	8-Φ18	SD41-1	20
	100	27.8	125	66																				
	130	36.1	114	67																				
100-315	30	8.33	34	66	1450	11	3	810	645	160	270	185	670	340	135	740	785	405	460	Φ220	Φ185	8-Φ18	SD41-1	20
	50	13.9	32																					
	65	18.1	30																					
100-315A	66.5	18.5	119	55	2900	55	4	1020	645	160	270	185	670	340	135	920	1070	720	460	Φ220	Φ185	8-Φ18	SD41-1	20
	95	26.4	113	66																				
	123.6	34.3	103	67																				
100-315A	28	7.78	30	64	1450	7.5	3	780	645	160	270	185	670	340	135	740	725	405	460	Φ220	Φ185	8-Φ18	SD41-1	20
	47.5	13	28																					
	61.5	16.8	26																					
100-315B	63	17.5	106.6	54	2900	45	4	940	645	160	270	185	670	340	135	840	990	610	400	Φ220	Φ185	8-Φ18	SD41-1	20
	90	25	101	65																				
	117	32.5	92	66																				
100-315B	24	6.67	22.5	63	1450	5.5	3	750	645	160	270	185	670	340	135	740	725	405	460	Φ220	Φ185	8-Φ18	SD41-1	20
	40.5	11.25	21																					
	48	13.3	19.3																					
100-315C	58	16.1	90	51	2900	37	4	895	645	160	270	185	645	315	135	795	945	460	450	Φ220	Φ185	8-Φ18	SD41-1	20
	82	22.8	85	63																				
	107	29.7	76	63																				
125-100	96	26.7	13	63	2900	11	4	715	480	140	180	120	490	270	120	640	765	430	430	Φ250	Φ210	8-Φ18	SD41-1	20
	160	44.4	12.5	80																				
	192	53.3	12	76																				
125-100A	86	23.9	10.4	60	2900	7.5	4	615	480	140	180	120	485	265	120	540	670	340	380	Φ250	Φ210	8-Φ18	SD41-1	20
	143	39.7	10	77																				
	172	47.8	9.6	74																				
125-125	96	26.7	22.6	62	2900	15	4	715	480	140	180	120	490	270	120	535	765	430	430	Φ250	Φ210	8-Φ18	SD41-1	20
	160	44.4	20	78																				
	192	53.3	17	78																				

Technical Parameter

Model	Flow Q		Head (m)	Eta (%)	Speed (r/min)	Power (kW)	NPSH (m)	Vertical Type Installation Size					Horizontal Type Installation Size					Flange Size			Vibration Isolators Spec	H1		
	m³/h	L/s						H	L	h	B	C	H	h	a	L1	L	L2	B1	D			D1	n-d
125-125	48	13.3	6	78	1450	2.2	3	595	480	140	180	120	490	270	120	975	575	640	430	Φ250	Φ210	8-Φ18	SD41-1	20
	100	27.8	5					825	525	170	220	180	530	270	125	740	850	405	460	Φ250	Φ210	8-Φ18	SD41-1	20
	120	33.3	4					825	525	170	220	180	530	270	125	740	850	405	460	Φ250	Φ210	8-Φ18	SD41-1	20
125-125A	86	23.9	18	60	2900	11	4	715	480	140	180	120	490	270	120	535	765	430	430	Φ250	Φ210	8-Φ18	SD41-1	20
	143	39.7	16	76				825	525	170	220	180	530	270	125	740	850	405	460	Φ250	Φ210	8-Φ18	SD41-1	20
	172	47.8	13.6	76				825	525	170	220	180	530	270	125	740	850	405	460	Φ250	Φ210	8-Φ18	SD41-1	20
125-160	96	26.7	36	64	2900	22	4	825	525	170	220	180	530	270	125	740	850	405	460	Φ250	Φ210	8-Φ18	SD41-1	20
	160	44.4	32	78				825	525	170	220	180	530	270	125	740	850	405	460	Φ250	Φ210	8-Φ18	SD41-1	20
	192	53.3	28	66				825	525	170	220	180	530	270	125	740	850	405	460	Φ250	Φ210	8-Φ18	SD41-1	20
125-160	48	13.3	9	78	1450	3	3	645	525	170	220	180	535	270	125	975	605	640	440	Φ250	Φ210	8-Φ18	SD41-1	20
	80	22.2	8					825	525	170	220	180	530	270	125	740	850	405	460	Φ250	Φ210	8-Φ18	SD41-1	20
	120	33.3	4					825	525	170	220	180	530	270	125	740	850	405	460	Φ250	Φ210	8-Φ18	SD41-1	20
125-160A	90	25	31.5	62	2900	18.5	4	825	525	170	220	180	530	270	125	695	815	430	440	Φ250	Φ210	8-Φ18	SD41-1	20
	150	41.7	28	76				825	525	170	220	180	530	270	125	695	815	430	440	Φ250	Φ210	8-Φ18	SD41-1	20
	180	50	24.5	64				825	525	170	220	180	530	270	125	695	815	430	440	Φ250	Φ210	8-Φ18	SD41-1	20
125-160A	42	11.6	11.2	73	1450	2.2	3	620	525	170	220	180	535	270	125	975	580	640	430	Φ250	Φ210	8-Φ18	SD41-1	20
	87.1	24.2	9.6					825	525	170	220	180	530	270	125	740	850	405	460	Φ250	Φ210	8-Φ18	SD41-1	20
	104	8.5	8.5					825	525	170	220	180	530	270	125	740	850	405	460	Φ250	Φ210	8-Φ18	SD41-1	20
125-160B	83	21.7	27	58	2900	15	4	745	525	170	220	180	530	270	125	695	770	430	440	Φ250	Φ210	8-Φ18	SD41-1	20
	138	38.3	24	73				825	525	170	220	180	530	270	125	695	770	430	440	Φ250	Φ210	8-Φ18	SD41-1	20
	166	46.1	21	60				825	525	170	220	180	530	270	125	695	770	430	440	Φ250	Φ210	8-Φ18	SD41-1	20
125-200	96	26.7	55	65	2900	37	5.5	895	570	160	180	120	575	290	130	795	930	460	450	Φ250	Φ210	8-Φ18	SD41-1	20
	160	44.4	50	77				825	525	170	220	180	530	270	125	695	770	430	440	Φ250	Φ210	8-Φ18	SD41-1	20
	192	53.3	46	76				825	525	170	220	180	530	270	125	695	770	430	440	Φ250	Φ210	8-Φ18	SD41-1	20
125-200	48	13.3	14	75	1450	5.5	3	710	570	160	180	120	580	290	130	975	680	640	430	Φ250	Φ210	8-Φ18	SD41-1	20
	80	22.2	12.5					825	525	170	220	180	530	270	125	695	770	430	440	Φ250	Φ210	8-Φ18	SD41-1	20
	120	33.3	11.5					825	525	170	220	180	530	270	125	695	770	430	440	Φ250	Φ210	8-Φ18	SD41-1	20
125-200A	90	25	48.4	73	2900	30	5.5	895	570	160	180	120	575	290	130	795	930	460	450	Φ250	Φ210	8-Φ18	SD41-1	20
	150	41.7	44	75				825	525	170	220	180	530	270	125	695	770	430	440	Φ250	Φ210	8-Φ18	SD41-1	20
	180	50	40.5	74				825	525	170	220	180	530	270	125	695	770	430	440	Φ250	Φ210	8-Φ18	SD41-1	20
125-200A	42	11.6	12.2	73	1450	4	3	665	570	160	180	120	580	290	130	975	650	640	430	Φ250	Φ210	8-Φ18	SD41-1	20
	75	20.8	11					825	525	170	220	180	530	270	125	695	770	430	440	Φ250	Φ210	8-Φ18	SD41-1	20
	104	28.9	8.5					825	525	170	220	180	530	270	125	695	770	430	440	Φ250	Φ210	8-Φ18	SD41-1	20
125-200B	83	21.7	41.3	61	2900	22	5.5	815	570	160	180	120	575	290	130	740	850	405	460	Φ250	Φ210	8-Φ18	SD41-1	20
	138	38.3	37.5	73				825	525	170	220	180	530	270	125	695	770	430	440	Φ250	Φ210	8-Φ18	SD41-1	20
	166	46.1	34.5	72				825	525	170	220	180	530	270	125	695	770	430	440	Φ250	Φ210	8-Φ18	SD41-1	20
125-200(l)	140	38.9	13.8	78	1450	11	3	820	680	200	260	210	665	340	140	695	835	430	440	Φ250	Φ210	8-Φ18	SD41-1	20
	200	55.6	12.5					825	525	170	220	180	530	270	125	695	770	430	440	Φ250	Φ210	8-Φ18	SD41-1	20
	260	72.2	10.6					825	525	170	220	180	530	270	125	695	770	430	440	Φ250	Φ210	8-Φ18	SD41-1	20

Technical Parameter

Model	Flow Q		Head (m)	Eta (%)	Speed (r/min)	Power (kW)	NPSH (m)	Vertical Type Installation Size					Horizontal Type Installation Size					Flange Size			Vibration Isolators Spec	H1		
	m³/h	L/s						H	L	h	B	C	H	h	a	L1	L	L2	B1	D			D1	n-d
125-200(l) A	125	34.7	11	76	1450	7.5	3	775	680	200	260	210	665	340	140	695	790	430	440	Φ250	Φ210	8-Φ18	SD41-1	20
	143	49.7	10					825	525	170	220	180	530	270	125	695	770	430	440	Φ250	Φ210	8-Φ18	SD41-1	20
	232.5	64.6	8.5					825	525	170	220	180	530	270	125	695	770	430	440	Φ250	Φ210	8-Φ18	SD41-1	20
125-250	96	26.7	87	61	2900	55	5.5	1020	600	160	260	210	665	365	165	920	1100	720	460	Φ250	Φ210	8-Φ18	SD41-1	20
	160	44.4	80	65				825	525	170	220	180	530	270	125	695	770	430	440	Φ250	Φ210	8-Φ18	SD41-1	20
	192	53.3	73	72				825	525	170	220	180	530	270	125	695	770	430	440	Φ250	Φ210	8-Φ18	SD41-1	20
125-250	48	13.3	22	74	1450	11	3	810	600	160	260	210	595	365	165	740	815	405	460	Φ250	Φ210	8-Φ18	SD41-1	20
	100	27.3	20					825	525	170	220	180	530	270	125	695	770	430	440	Φ250	Φ210	8-Φ18	SD41-1	20
	120	33.3	18.3					825	525	170	220	180	530	270	125	695	770	430	440	Φ250	Φ210	8-Φ18	SD41-1	20
125-250A	90	25	76	74	2900	45	5.5	965	600	160	260	210	640	340	165	840	1020	610	400	Φ250	Φ210	8-Φ18	SD41-1	20
	150	41.7	70					825	525	170	220	180	530	270	125	695	770	430	440	Φ250	Φ210	8-Φ18	SD41-1	20
	180	50	64					825	525	170	220	180	530	270	125	695	770	430	440	Φ250	Φ210	8-Φ18	SD41-1	20
125-250A	45	12.5	19	73	1450	7.5	3	810	600	160	260	210	590	340	165	975	755	640	430	Φ250	Φ210	8-Φ18	SD41-1	20
	93.3	25.9	17.5					825	525	170	220	180	530	270	125	695	770	430	440	Φ250	Φ210	8-Φ18	SD41-1	

Technical Parameter

Model	Flow Q		Head (m)	Eta (%)	Speed (r/min)	Power (kW)	NPSH (m)	Vertical Type Installation Size					Horizontal Type Installation Size					Flange Size			Vibration Isolators Spec	H1		
	m³/h	L/s						H	L	h	B	C	H	h	a	L1	L	L2	B1	D			D1	n-d
125-315B	86	23.9	106.4	53	2900	75	5	1130	680	190	280	210	700	370	150	1235	1160	840	520	Φ250	Φ210	8-Φ18	SD41-1	20
	143	39.7	100	68																				
	172	47.8	95.2	70																				
125-315B	52	14.4	25	70	1450	11	3	840	680	190	280	210	700	370	150	740	795	405	460	Φ250	Φ210	8-Φ18	SD41-1	20
	87	24.2	24																					
	104	28.9	23																					
125-315C	80.5	22.4	96	67	2900	55	5	1050	680	190	280	210	700	370	150	1185	1080	800	520	Φ250	Φ210	8-Φ18	SD41-1	20
	134	37.2	88																					
	160	44.7	86																					
125-315(I)	140	38.9	33.8	78	1450	22	2.5	940	765	205	260	210	770	395	140	850	955	610	470	Φ250	Φ210	8-Φ18	SD41-1	20
	200	55.6	32																					
	260	72.5	28																					
125-315(I) A	131	36.4	29.5	77	1450	18.5	3.5	900	765	205	260	210	770	395	140	810	915	570	470	Φ250	Φ210	8-Φ18	SD41-1	20
	187	51.9	28																					
	243	67.5	24.5																					
125-315(I) B	121	33.6	25	75	1450	15	3.5	860	765	205	260	210	770	395	140	770	875	530	470	Φ250	Φ210	8-Φ18	SD41-1	20
	173	48.1	24																					
	225	62.5	21																					
125-400(I) A	131	36.4	46.6	74	1450	37	3.5	975	795	195	260	210	830	430	140	850	1000	610	470	Φ250	Φ210	8-Φ18	SD41-1	20
	187	51.9	40																					
	243	67.5	38.3																					
150-160	100	27.8	33.5	63	2900	22	4.5	820	520	170	230	140	535	270	130	695	820	430	440	Φ285	Φ240	8-Φ22	SD41-1	20
	160	41.2	32																					
	200	55.5	24																					
150-160(I)	120	33.3	35	64	2900	30	4.5	820	525	165	240	150	535	270	130	740	855	405	460	Φ285	Φ240	8-Φ22	SD41-1	20
	200	55.5	32																					
	240	66.7	28																					
150-200	140	38.9	13.8	78	1450	15	3	820	680	200	260	210	665	340	140	695	835	430	440	Φ285	Φ240	8-Φ22	SD41-1	20
	200	55.6	12.5																					
	260	72.2	10.6																					
150-200A	125	34.7	11	66	1450	11	3	775	680	200	260	210	665	340	140	695	790	430	440	Φ285	Φ240	8-Φ22	SD41-1	20
	179	49.7	10																					
	232.5	64.6	8.5																					
150-250	140	38.9	21.8	73	1450	18.5	3	855	700	200	260	210	680	340	145	740	845	405	460	Φ285	Φ240	8-Φ22	SD41-1	20
	200	55.6	20																					
	260	72.2	17																					
150-250A	129	35.8	18.5	72	1450	15	3	820	700	200	260	210	680	340	145	740	845	405	460	Φ285	Φ240	8-Φ22	SD41-1	20
	184.4	51.2	17																					
	240	66.7	14.4																					

Technical Parameter

Model	Flow Q		Head (m)	Eta (%)	Speed (r/min)	Power (kW)	NPSH (m)	Vertical Type Installation Size					Horizontal Type Installation Size					Flange Size			Vibration Isolators Spec	H1		
	m³/h	L/s						H	L	h	B	C	H	h	a	L1	L	L2	B1	D			D1	n-d
150-250B	117	32.5	15.2	76	1450	11	3	775	700	200	260	210	680	340	145	740	800	405	460	Φ285	Φ240	8-Φ22	SD41-1	20
	167	46.4	14																					
	217.5	60.4	12																					
150-315	140	38.9	33.8	70	1450	30	2.5	940	765	205	260	210	770	395	140	850	955	610	470	Φ285	Φ240	8-Φ22	SD41-1	20
	200	55.6	32																					
	260	72.2	28																					
150-315A	131	36.4	29.5	69	1450	22	3.5	900	765	205	260	210	770	395	140	810	915	576	470	Φ285	Φ240	8-Φ22	SD41-1	20
	187	51.9	28																					
	243	67.5	24.5																					
150-315B	121	33.6	25	60	1450	18.5	3.5	860	765	205	260	210	770	395	140	770	875	530	470	Φ285	Φ240	8-Φ22	SD41-1	20
	173	48.1	24																					
	225	62.5	21																					
150-400	140	38.9	53	68	1450	45	3.5	1000	795	195	260	210	830	430	140	880	1025	640	470	Φ285	Φ240	8-Φ22	SD41-1	20
	200	55.6	50																					
	260	72.2	44																					
150-400A	131	36.4	46.6	67	1450	37	3.5	975	795	195	260	210	830	430	140	850	1000	610	470	Φ285	Φ240	8-Φ22	SD41-1	20
	187	51.9	44																					
	243	67.5	38.3																					
150-400B	122	33.9	40	66	1450	30	3.5	930	795	195	260	210	830	430	140	850	955	610	470	Φ285	Φ240	8-Φ22	SD41-1	20
	174	48.3	38																					
	226.5	62.9	33																					
150-400C	112	31.1	34	64	1450	22	3.5	890	795	195	260	210	830	430	140	820	915	580	470	Φ285	Φ240	8-Φ22	SD41-1	20
	160	44.4	32																					
	208	57.8	28																					
150-250(I)	120	33.3	87	65	2900	75	4.5	1145	755	205	315	250	725	365	145	880	1245	640	470	Φ285	Φ240	8-Φ22	SD41-1	20
	200	55.6	80																					
	240	66.7	72																					
150-250(I) A	112	31.1	76	64	2900	55	4.5	1065	755	205	315	250	725	365	145	850	1175	610	470	Φ285	Φ240	8-Φ22	SD41-1	20
	187	51.9	70																					
	224	62.2	63																					
150-250(I) B	104	28.9	65	63	2900	45	4.5	1010	755	205	315	250	725	365	145	850	1090	580	470	Φ285	Φ240	8-Φ22	SD41-1	20
	173	48.1	60																					
	208	57.8	54																					
150-315(I)	120	33.3	133	58	2900	110	4.5	1265	805	210	275	220	800	400	170	1220	1275	980	620	Φ285	Φ240	8-Φ22	SD41-1	20
	200	55.6	125																					
	240	66.7	120																					
150-315(I) A	112	31.1	116	57	2900	90	4.5	1200	805	210	275	220	800	400	170	1180	1235	940	620	Φ285	Φ240	8-Φ22	SD41-1	20
	187	51.9	110																					
	224	62.2	105																					

Technical Parameter

Model	Flow Q		Head (m)	Eta (%)	Speed (r/min)	Power (kW)	NPSH (m)	Vertical Type Installation Size					Horizontal Type Installation Size					Flange Size			Vibration Isolators Spec	H1		
	m³/h	L/s						H	L	h	B	C	H	h	a	L1	L	L2	B1	D			D1	n-d
150-315(I) B	104	28.9	100	55	1450	75	4.5	1150	805	210	275	220	800	400	170	1140	1175	900	620	Φ285	Φ240	8-Φ22	SD41-1	20
	173	48.1	95	70				1150	805	210	275	220	800	400	170	1140	1175	900	620	Φ285	Φ240	8-Φ22	SD41-1	20
	208	57.8	91	72				1150	805	210	275	220	800	400	170	1140	1175	900	620	Φ285	Φ240	8-Φ22	SD41-1	20
200-200	140	38.9	13.8	68	1450	15	3	830	680	210	315	250	660	340	160	640	855	430	430	Φ340	Φ295	12-Φ22	SD41-1	20
	200	55.6	12.5	78				830	680	210	315	250	660	340	160	640	855	430	430	Φ340	Φ295	12-Φ22	SD41-1	20
	260	72.2	10.6	78				830	680	210	315	250	660	340	160	640	855	430	430	Φ340	Φ295	12-Φ22	SD41-1	20
200-200A	125	34.7	11	66	1450	11	3	785	680	210	315	250	660	340	160	640	810	430	430	Φ340	Φ295	12-Φ22	SD41-1	20
	179	49.7	10	76				785	680	210	315	250	660	340	160	640	810	430	430	Φ340	Φ295	12-Φ22	SD41-1	20
	232.5	64.6	8.5	76				785	680	210	315	250	660	340	160	640	810	430	430	Φ340	Φ295	12-Φ22	SD41-1	20
200-250	140	38.9	21.8	73	1450	18.5	3	1145	755	205	315	250	700	340	165	740	895	405	460	Φ340	Φ295	12-Φ22	SD41-1	20
	200	55.6	20	79				1145	755	205	315	250	700	340	165	740	895	405	460	Φ340	Φ295	12-Φ22	SD41-1	20
	260	72.2	17	77				1145	755	205	315	250	700	340	165	740	895	405	460	Φ340	Φ295	12-Φ22	SD41-1	20
200-250A	129	35.8	18.5	72	1450	15	3	1065	755	205	315	250	700	340	165	740	860	405	460	Φ340	Φ295	12-Φ22	SD41-1	20
	184.4	51.3	17	78				1065	755	205	315	250	700	340	165	740	860	405	460	Φ340	Φ295	12-Φ22	SD41-1	20
	240	66.2	14.4	76				1065	755	205	315	250	700	340	165	740	860	405	460	Φ340	Φ295	12-Φ22	SD41-1	20
200-250B	117	32.5	15.2	70	1450	11	3	1010	755	205	315	250	700	340	165	740	815	405	460	Φ340	Φ295	12-Φ22	SD41-1	20
	167	46.4	14	76				1010	755	205	315	250	700	340	165	740	815	405	460	Φ340	Φ295	12-Φ22	SD41-1	20
	217.5	60.4	12	73				1010	755	205	315	250	700	340	165	740	815	405	460	Φ340	Φ295	12-Φ22	SD41-1	20
200-315	140	38.9	33.8	70	1450	30	3.5	1265	805	210	275	220	800	400	170	850	980	570	470	Φ340	Φ295	12-Φ22	SD41-1	20
	200	55.6	32	78				1265	805	210	275	220	800	400	170	850	980	570	470	Φ340	Φ295	12-Φ22	SD41-1	20
	260	72.2	28	78				1265	805	210	275	220	800	400	170	850	980	570	470	Φ340	Φ295	12-Φ22	SD41-1	20
200-315A	131	36.4	29.5	69	1450	22	3.5	1200	805	210	275	220	800	400	170	770	940	530	470	Φ340	Φ295	12-Φ22	SD41-1	20
	187	51.6	28	77				1200	805	210	275	220	800	400	170	770	940	530	470	Φ340	Φ295	12-Φ22	SD41-1	20
	243	67.5	24.5	77				1200	805	210	275	220	800	400	170	770	940	530	470	Φ340	Φ295	12-Φ22	SD41-1	20
200-315B	121	33.6	25	67	1450	18.5	3.5	1150	805	210	275	220	800	400	170	770	900	530	470	Φ340	Φ295	12-Φ22	SD41-1	20
	173	48.1	24	75				1150	805	210	275	220	800	400	170	770	900	530	470	Φ340	Φ295	12-Φ22	SD41-1	20
	225	62.5	21	74				1150	805	210	275	220	800	400	170	770	900	530	470	Φ340	Φ295	12-Φ22	SD41-1	20
200-400	140	38.9	53	68	1450	45	3.5	1045	885	240	315	250	870	435	145	880	1030	640	470	Φ340	Φ295	12-Φ22	SD41-1	20
	200	55.6	50	75				1045	885	240	315	250	870	435	145	880	1030	640	470	Φ340	Φ295	12-Φ22	SD41-1	20
	260	72.2	44	71				1045	885	240	315	250	870	435	145	880	1030	640	470	Φ340	Φ295	12-Φ22	SD41-1	20
200-400A	131	36.4	46.4	67	1450	37	3.5	1020	885	240	315	250	870	435	145	850	1005	610	470	Φ340	Φ295	12-Φ22	SD41-1	20
	187	51.9	44	74				1020	885	240	315	250	870	435	145	850	1005	610	470	Φ340	Φ295	12-Φ22	SD41-1	20
	248	67.5	38.3	70				1020	885	240	315	250	870	435	145	850	1005	610	470	Φ340	Φ295	12-Φ22	SD41-1	20
200-400B	122	33.9	40	66	1450	30	3.5	975	885	240	315	250	865	430	145	850	960	610	470	Φ340	Φ295	12-Φ22	SD41-1	20
	174	48.3	38	73				975	885	240	315	250	865	430	145	850	960	610	470	Φ340	Φ295	12-Φ22	SD41-1	20
	226.5	62.9	33	68				975	885	240	315	250	865	430	145	850	960	610	470	Φ340	Φ295	12-Φ22	SD41-1	20
200-400C	112	31.3	34	63	1450	22	3.5	935	885	240	315	250	865	430	145	810	920	570	470	Φ340	Φ295	12-Φ22	SD41-1	20
	160	44.4	32	71				935	885	240	315	250	865	430	145	810	920	570	470	Φ340	Φ295	12-Φ22	SD41-1	20
	208	57.8	28	65				935	885	240	315	250	865	430	145	810	920	570	470	Φ340	Φ295	12-Φ22	SD41-1	20

Technical Parameter

Model	Flow Q		Head (m)	Eta (%)	Speed (r/min)	Power (kW)	NPSH (m)	Vertical Type Installation Size					Horizontal Type Installation Size					Flange Size			Vibration Isolators Spec	H1		
	m³/h	L/s						H	L	h	B	C	H	h	a	L1	L	L2	B1	D			D1	n-d
200-200(I)	280	77.8	13.4	70	1450	22	4	950	820	255	315	250	785	395	165	810	955	570	470	Φ340	Φ295	12-Φ22	SD41-1	20
	400	111.1	12.5	80				950	820	255	315	250	785	395	165	810	955	570	470	Φ340	Φ295	12-Φ22	SD41-1	20
	520	144	10.5	79				950	820	255	315	250	785	395	165	810	955	570	470	Φ340	Φ295	12-Φ22	SD41-1	20
200-200(I) A	250	69.4	10.7	68	1450	18.5	4	910	820	255	315	250	785	395	165	770	915	530	470	Φ340	Φ295	12-Φ22	SD41-1	20
	358	99.4	10	78				910	820	255	315	250	785	395	165	770	915	530	470	Φ340	Φ295	12-Φ22	SD41-1	20
	465	129.2	8.5	77				910	820	255	315	250	785	395	165	770	915	530	470	Φ340	Φ295	12-Φ22	SD41-1	20
200-250(I)	280	77.8	22.2	75	1450	30	4	955	830	220	315	250	800	395	155	850	990	610	470	Φ340	Φ295	12-Φ22	SD41-1	20
	400	111.4	20	80				955	830	220	315	250	800	395	155	850	990	610	470	Φ340	Φ295	12-Φ22	SD41-1	20
	520	144	14	72				955	830	220	315	250	800	395	155	850	990	610	470	Φ340	Φ295	12-Φ22	SD41-1	20
200-250(I) A	250	69.4	18	73	1450	22	4	915	830	220	315	250	800	395	155	810	950	570	470	Φ340	Φ295	12-Φ22	SD41-1	20
	358	99.4	16	78				915	830	220	315	250	800	395	155	810	950	570	470	Φ340	Φ295	12-Φ22	SD41-1	20
	465	129.2	11.2	70				915	830	220	315	250	800	395	155	810	950	570	470	Φ340	Φ295	12-Φ22	SD41-1	20
200-250(I) B	226	62.8	14.4	70	1450	18.5	4	875	830	220	315	250	800	395	155	770	910	530	470	Φ340	Φ295	12-Φ22	SD41-1	20
	322	89.4	13	75				875	830	220	315	250	800	395	155	770	910	530	470	Φ340	Φ295	12-Φ22	SD41-1	20
	419	116.4	7.3	67				875	830	220	315	250	800	395	155	770	910	530	470	Φ340	Φ295	12-Φ22	SD41-1	20
200-315(I)	280	77.8	36	73	1450	55	4	1230	890	240	315	250	855	435	170	960	1120	720	520	Φ340	Φ295	12-Φ22	SD41-1	20
	400	111.4	32	80				1230	890	240	315	250	855	435	170	960	1120	720	520	Φ340	Φ295	12-Φ22	SD41-1	20
	520	144	26	75				1230	890	240	315	250	855	435	170	960	1120	720	520	Φ340	Φ295	12-Φ22	SD41-1	20
200-315(I) A	262	72.8	31.5																					

Technical Parameter

Model	Flow Q		Head (m)	Eta (%)	Speed (r/min)	Power (kW)	NPSH (m)	Vertical Type Installation Size					Horizontal Type Installation Size					Flange Size			Vibration Isolators	H1		
	m³/h	L/s						H	L	h	B	C	H	h	a	L1	L	L2	B1	D			D1	n-d
200-500A	187	51.9	76	77	1450	90	4	1580	1100	240	320	250	1080	530	140	1180	1500	940	620	Φ340	Φ295	12-Φ22	SD41-1	20
	300	83.3	70																					
	350	98.6	64																					
200-500B	173	48.1	65	76	1450	75	4	1410	1100	240	320	250	1060	510	140	1140	1330	900	620	Φ340	Φ295	12-Φ22	SD41-1	20
	277	76.9	60																					
	326	91.4	55																					
200-500C	158	43.9	55	74	1450	55	4	1360	1100	240	320	250	1060	510	140	1080	1280	840	620	Φ340	Φ295	12-Φ22	SD41-1	20
	253	70.3	50																					
	300	83.3	45																					
200-500(I)	250	69.4	88	80	1450	132	4	1610	1100	240	320	250	1080	530	180	1220	1530	980	620	Φ340	Φ295	12-Φ22	SD41-1	20
	400	111.1	80																					
	520	144	70																					
200-500(I) A	228	63.3	76.5	78	1450	110	4	1610	1100	240	320	250	1080	530	180	1220	1530	980	620	Φ340	Φ295	12-Φ22	SD41-1	20
	375	104.2	70																					
	486	135	61																					
200-500(I) B	210	58.8	65	84	1450	90	4	1580	1100	240	320	250	1080	530	180	1180	1500	940	620	Φ340	Φ295	12-Φ22	SD41-1	20
	340	94.4	60																					
	450	125	52.5																					
200-500(I) C	198	55	55	82	1450	75	4	1410	1100	240	320	250	1060	510	180	1140	1330	900	620	Φ340	Φ295	12-Φ22	4-SD61-1	20
	320	88.9	50																					
	415	115.2	44																					
250-250	320	88.9	23	82	1450	45	5	1200	1000	320	450	350	885	435	200	880	1130	640	470	Φ405	Φ355	12-Φ22	4-SD61-1.5	20
	550	152.8	20																					
	670	186	17																					
250-250A	285	79.2	19	80	1450	37	5	1180	1000	320	450	350	885	435	200	850	1115	610	470	Φ405	Φ355	12-Φ22	4-SD61-1.5	20
	500	138	17																					
	600	166.7	14.5																					
250-315	320	88.9	35	80	1450	75	5	1410	1100	320	450	350	870	435	200	1040	1295	800	570	Φ405	Φ355	12-Φ22	4-SD61-1.5	20
	550	152.8	32																					
	640	177.8	28																					
250-315A	300	83.3	31	80	1450	55	5	1310	1100	320	450	350	870	435	200	970	1190	720	570	Φ405	Φ355	12-Φ22	4-SD61-1.5	20
	515	143	28																					
	600	166.7	24.5																					
250-315B	277	76.9	27	78	1450	45	5	1250	1100	320	450	350	870	435	200	910	1130	640	570	Φ405	Φ355	12-Φ22	4-SD61-1.5	20
	450	125	24																					
	554	153.9	21																					
250-400	320	89	54	80	1450	110	5	1560	1200	320	450	350	985	445	200	1120	1440	880	600	Φ405	Φ355	12-Φ22	6-SD61-1.5	20
	550	152	50																					
	640	177.8	46																					

Technical Parameter

Model	Flow Q		Head (m)	Eta (%)	Speed (r/min)	Power (kW)	NPSH (m)	Vertical Type Installation Size					Horizontal Type Installation Size					Flange Size			Vibration Isolators	H1		
	m³/h	L/s						H	L	h	B	C	H	h	a	L1	L	L2	B1	D			D1	n-d
250-400A	300	83.3	47.5	78	1450	90	5	1460	1200	320	450	350	985	445	200	1080	1340	840	520	Φ405	Φ355	12-Φ22	6-SD61-1.5	20
	515	143	44.4																					
	600	166.7	40.5																					
250-400B	277	76.9	40.5	80	1450	75	5	1410	1200	320	450	350	985	445	200	1040	1290	800	520	Φ405	Φ355	12-Φ22	6-SD61-1.5	20
	476	132.2	37.5																					
	554	153.9	34.5																					
250-500	330	91.7	85	79	1450	200	5	1915	1300	320	450	350	1185	535	200	1380	1775	1100	700	Φ405	Φ355	12-Φ22	6-SD61-1.5	20
	550	152.8	80																					
	660	183.3	75																					
250-500A	312	86.7	78	78	1450	160	5	1730	1300	320	450	350	1185	530	200	1300	1590	1020	620	Φ405	Φ355	12-Φ22	6-SD61-1.5	20
	520	144.4	72																					
	624	173.3	67																					
250-500B	295	81	68	77	1450	132	5	1690	1300	320	450	350	1185	530	200	1250	1550	970	620	Φ405	Φ355	12-Φ22	6-SD61-1.5	20
	490	136.1	64																					
	590	163.9	60																					
250-500C	274	76.1	58.5	83	1450	110	5	1690	1300	320	450	350	1185	530	200	1200	1520	920	620	Φ405	Φ355	12-Φ22	6-SD61-1.5	20
	456	126.7	55																					
	578	152.2	52																					
300-250	450	125	24	81	1450	55	5	1505	1250	385	450	350	975	475	220	1150	1340	870	520	Φ460	Φ410	12-Φ22	6-SD61-1.5	20
	720	200	20																					
	900	250	17																					
300-250A	400	111.1	19.5	81	1450	45	5	1402	1250	385	450	350	975	475	220	1080	1255	800	520	Φ460	Φ410	12-Φ22	6-SD61-1.5	20
	600	166.7	17																					
	800	222.2	13																					
300-235	430	133.3	20	81	1450	55	5	1500	1250	385	450	350	990	580	250	1140	1425	860	670	Φ460	Φ410	12-Φ22	6-SD61-1.5	20
	720	200	18																					
	900	250	15.5																					
300-235	450	125	20.5	79	1000	55	5	1500	1250	385	450	350	990	580	250	1140	1425	860	670	Φ460	Φ410	12-Φ22	4-SD61-1.5	20
	720	200	18																					
	900	250	15.5																					
300-235A	438	121.7	16.7	79	1450	45	5	1500	1250	385	450	350	990	580	250	1100	1375	820	670	Φ460	Φ410	12-Φ22	6-SD61-1.5	20
	657	182.5	15																					
	821	228.1	12.9																					
300-235A	410	113.9	17.5	81	1000	45	5	1500	1250	385	450	350	990	580	250	1100	1375	820	670	Φ460	Φ410	12-Φ22	4-SD61-1.5	20
	657	182.5	15																					
	820	227.8	12.8																					
300-235B	400	111.1	13.9	77	1450	37	5	1530	1000	385	450	350	970	560	250	1050	1325	780	620	Φ460	Φ410	12-Φ22	6-SD61-1.5	20
	600	167	12.5																					
	750	208.3	10.8																					

Technical Parameter

Model	Flow Q		Head (m)	Eta (%)	Speed (r/min)	Power (kW)	NPSH (m)	Vertical Type Installation Size					Horizontal Type Installation Size						Flange Size			Vibration Isolators	H1	
	m³/h	L/s						H	L	h	B	C	H	h	a	L1	L	L2	B1	D	D1			n-d
300-235(l)	718	199.3	44.6	80	1450	160	5	1790	1250	385	450	350	990	580	250	1300	1665	1020	670	Φ460	Φ410	12-Φ22	4-SD61-1.5	20
	1080	300	40																					
	1345	373.6	34.6																					
300-235(l) A	642	178.3	35.7	81	1450	132	5	1790	1250	385	450	350	990	580	250	1220	1570	940	670	Φ460	Φ410	12-Φ22	4-SD61-1.5	20
	965	268	32																					
	1203	334.2	27.7																					
300-300	450	125	31.5	80	1000	75	5	1640	1350	385	450	350	1230	580	250	1180	1515	900	670	Φ460	Φ410	12-Φ22	4-SD61-1.5	20
	720	200	28																					
	900	250	25																					
300-300A	416	115.6	27	79	1000	75	5	1550	1350	385	450	350	1230	580	250	1180	1515	900	670	Φ460	Φ410	12-Φ22	4-SD61-1.5	20
	666	182	24																					
	832	231.1	21.5																					
300-300B	390	108.3	23.5	84	1000	55	5	1490	1350	385	450	350	1230	580	250	1140	1425	860	670	Φ460	Φ410	12-Φ22	4-SD61-1.5	20
	623	173.1	21																					
	780	216.7	18.5																					
300-315B	390	108.3	28	80	1450	55	4.8	1480	1000	360	500	400	1010	455	220	1150	1340	870	520	Φ460	Φ410	12-Φ22	4-SD61-1.5	20
	563	156.4	24																					
	780	216.7	19																					
300-315	450	125	37	80	1450	90	4.8	1530	1000	360	500	400	1010	455	220	1200	1390	920	520	Φ460	Φ410	12-Φ22	6-SD61-2	20
	720	200	32																					
	909	250	27																					
300-315A	420	116.7	32	78	1450	75	4.8	1480	1000	360	500	400	1010	455	220	1150	1340	870	520	Φ460	Φ410	12-Φ22	6-SD61-2	20
	670	186.1	28																					
	840	233.3	22																					
300-380	450	125	48	80	1000	132	5	1780	1500	385	500	400	1315	610	250	1280	1660	1000	770	Φ460	Φ410	12-Φ22	4-SD61-2	20
	720	200	44																					
	900	250	38																					
300-380A	416	115.6	42	78	1000	110	5	1780	1500	385	500	400	1315	610	250	1280	1660	1000	770	Φ460	Φ410	12-Φ22	4-SD61-2	20
	666	185	38																					
	832	231.1	33																					
300-380B	390	108.3	36	82	1000	90	5	1680	1500	385	500	400	1315	610	250	1240	1510	900	770	Φ460	Φ410	12-Φ22	4-SD61-2	20
	623	173.6	33																					
	780	216.7	28																					
300-400	450	125	56	80	1450	132	4.5	1770	1500	360	500	400	1110	510	220	1340	1630	1060	600	Φ460	Φ410	12-Φ22	6-SD61-2	20
	720	200	50																					
	900	250	44																					
300-400A	420	116.7	48	78	1450	110	4.5	1730	1500	360	500	400	1110	510	220	1280	1590	1000	600	Φ460	Φ410	12-Φ22	6-SD61-2	20
	670	186.1	44																					
	840	233.3	37																					

Technical Parameter

Model	Flow Q		Head (m)	Eta (%)	Speed (r/min)	Power (kW)	NPSH (m)	Vertical Type Installation Size					Horizontal Type Installation Size						Flange Size			Vibration Isolators	H1	
	m³/h	L/s						H	L	h	B	C	H	h	a	L1	L	L2	B1	D	D1			n-d
300-400B	390	108.3	42	77	1450	90	4.5	1700	1500	360	500	400	1110	510	220	1240	1560	960	600	Φ460	Φ410	12-Φ22	6-SD61-2	20
	625	173.6	38																					
	780	216.7	32																					
300-400C	360	100	36	80	1450	75	4.5	1530	1500	360	500	400	1110	510	220	1200	1390	920	600	Φ460	Φ410	12-Φ22	6-SD61-2	20
	575	159.7	32																					
	720	200	28																					
300-500	450	125	86	79	1450	250	4.5	1955	1500	360	500	400	1210	560	220	1420	1815	1140	700	Φ460	Φ410	12-Φ22	6-SD61-2.5	20
	720	200	80																					
	900	250	74																					
300-500A	420	116.7	79	78	1450	200	4.5	1955	1500	360	500	400	1210	560	220	1420	1815	1140	700	Φ460	Φ410	12-Φ22	6-SD61-2.5	20
	670	182.1	70																					
	840	233.3	64																					
300-500B	390	108.3	65	77	1450	160	4.5	1955	1300	360	500	400	1210	560	220	1420	1815	1140	700	Φ460	Φ410	12-Φ22	4-SD61-2.5	20
	625	173.6	60																					
	780	216.7	54																					
300-500C	360	100	57	82	1450	132	4.5	1770	1300	360	500	400	1210	560	220	1340	1630	1060	700	Φ460	Φ410	12-Φ22	4-SD61-2.5	20
	575	159.7	52																					
	720	200	47																					
350-200	720	200	16	80	1450	55	5.5	1445	1100	410	600	500	1025	475	250	1140	1285	820	520	Φ505	Φ460	16-Φ22	4-SD61-2.5	20
	1200	333.3	12.5																					
	1440	400	10.5																					
350-200A	650	180.6	13	78	1450	45	5.5	1365	1100	410	600	500	1025	475	250	1080	1200	760	520	Φ505	Φ460	16-Φ22	4-SD61-2.5	20
	1080	300	10																					
	1300	361.1	8.5																					
350-250	720	200	24	81	1450	90	5.5	1580	1100	410	600	500	1025	475	250	1260	1420	940	620	Φ505	Φ460	16-Φ22	4-SD61-2.5	20
	1200	333.3	20																					
	1440	400.1	17																					
350-250	480	133.3	230	81	1000	75	5	1660	1300	380	500	400	1290	590	280	1220	1555	940	670	Φ505	Φ460	16-Φ22	4-SD61-2.5	20
	800	222.2	20																					
	960	266.7	17.5																					
350-250	720	200	24	81	1450	90	5.5	1580	1100	410	600	500	1025	475	250	1260	1420	940	620	Φ505	Φ460	16-Φ22	4-SD61-2.5	20
	1200	333.3	20																					
	1440	400.1	17																					
350-250A	650	180.6	19.5	81	1450	75	5.5	1530	1100	410	600	500	1025	475	250	1200	1370	880	520	Φ505	Φ460	16-Φ22	4-SD61-2.5	20
	1080	300	16																					
	1300	361.1	13.5																					
350-250A	430	119.4	18.5	81	1000	55	5.5	1560	1300	380	500	400	1290	590	280	1180	1465	860	670	Φ505	Φ460	16-Φ22	4-SD61-2.5	20
	715	198.6	16																					
	860	238.9	14																					

Technical Parameter

Model	Flow Q		Head (m)	Eta (%)	Speed (r/min)	Power (kW)	NPSH (m)	Vertical Type Installation Size					Horizontal Type Installation Size					Flange Size			Vibration Isolators	H1		
	m³/h	L/s						H	L	h	B	C	H	h	a	L1	L	L2	B1	D			D1	n-d
350-315	720	200	36	80	1450	160	5.5	1820	1200	410	600	500	1130	530	250	1400	1660	1080	600	Φ505	Φ460	16-Φ22	4-SD61-2.5	20
	1200	333.3	33																					
	1440	400	28																					
350-315	480	133.2	35	79	1000	90	5	1690	1400	380	500	400	1310	635	250	1220	1555	940	720	Φ505	Φ460	16-Φ22	4-SD61-2.5	20
	800	222.2	32																					
	960	266.7	27																					
350-315A	670	186.1	31.5	78	1450	132	5.5	1750	1200	410	600	500	1130	530	250	1300	1590	980	600	Φ505	Φ460	16-Φ22	4-SD61-2.5	20
	1120	311.1	28																					
	1340	372.2	24																					
350-315A	450	125	45.5	78	1000	75	5	1640	1400	380	500	400	1310	635	250	1180	1505	1020	720	Φ505	Φ460	16-Φ22	4-SD61-2.5	20
	720	208.3	44																					
	900	250	40																					
350-315B	625	173.6	27	80	1450	110	5.5	1580	1200	410	600	500	1130	530	250	1260	1420	940	600	Φ505	Φ460	16-Φ22	4-SD61-2.5	20
	1040	288.9	24																					
	1250	347.2	20																					
350-315B	416	115.6	26	80	1000	75	5	1250	1400	380	500	400	1310	635	250	1180	1505	900	720	Φ505	Φ460	16-Φ22	4-SD61-2.5	20
	692	192.2	24																					
	832	231.1	20																					
350-400	720	200	55	79	1450	250	5.5	2005	1300	410	600	500	1210	560	250	1560	1854	1240	700	Φ505	Φ460	16-Φ22	4-SD61-3	20
	1200	333.3	50																					
	1440	400	45																					
350-400A	670	186.1	47.5	78	1450	220	5.5	2005	1300	410	600	500	1210	560	250	1560	1854	1240	700	Φ505	Φ460	16-Φ22	4-SD61-3	20
	1120	311.1	44																					
	1340	372.2	39																					
350-400B	625	173.6	41.5	77	1450	200	5.5	1820	1300	410	600	500	1210	560	250	1400	1660	1080	700	Φ505	Φ460	16-Φ22	4-SD61-3	20
	1040	288.9	38																					
	1250	347.2	34																					
350-400C	575	159.7	35	80	1450	160	5.5	1780	1300	410	600	500	1210	560	250	1400	1620	1080	700	Φ505	Φ460	16-Φ22	4-SD61-3	20
	960	266.7	32																					
	1150	319.4	28.5																					
350-400	480	133.3	53	79	1000	160	5	2220	1500	380	500	400	1360	680	280	1360	1850	1060	770	Φ505	Φ460	16-Φ22	4-SD61-3	20
	800	222.2	50																					
	960	266.7	46																					
350-400A	450	125	46.5	78	1000	132	5	2180	1500	380	500	400	1360	680	280	1310	1685	990	770	Φ505	Φ460	16-Φ22	4-SD61-3	20
	720	208.3	44																					
	900	250	40																					
350-400B	418	116.1	42	83	1000	110	5	1780	1500	380	500	400	1360	680	280	1310	1685	990	770	Φ505	Φ460	16-Φ22	4-SD61-3	20
	697	193.6	38																					
	836	232.2	34.5																					

Technical Parameter

Model	Flow Q		Head (m)	Eta (%)	Speed (r/min)	Power (kW)	NPSH (m)	Vertical Type Installation Size					Horizontal Type Installation Size					Flange Size			Vibration Isolators	H1		
	m³/h	L/s						H	L	h	B	C	H	h	a	L1	L	L2	B1	D			D1	n-d
350-480	540	150	69	79	1450	220	5	1955	1300	360	500	400	1210	560	250	1420	1815	1140	700	Φ505	Φ460	16-Φ22	4-SD61-3	20
	900	250	65																					
	1080	300	58																					
350-480A	510	141.6	60	78	1450	200	5	1955	1300	360	500	400	1210	560	250	1420	1815	1140	700	Φ505	Φ460	16-Φ22	4-SD61-3	20
	850	236	56																					
	1020	283.3	50																					
350-480B	480	133.3	53	77	1450	160	5	1955	1300	360	500	400	1210	560	250	1420	1815	1140	700	Φ505	Φ460	16-Φ22	4-SD61-3	20
	800	222.2	50																					
	960	266.7	45																					
350-480B	446	123.8	46	82	1450	132	5	1770	1300	360	500	400	1210	560	250	1340	1630	1060	700	Φ505	Φ460	16-Φ22	4-SD61-3	20
	744	206.6	43																					
	893	248	39																					
400-400	650	180.6	15	82	1000	55	5	200	1700	410	600	500	1280	580	280	1180	1465	990	670	Φ520	Φ525	16-Φ30	4-SD61-2.5	20
	1080	300	12.5																					
	1300	361	11																					
400-400A	680	161.1	12	81	1000	45	5	1800	1700	410	600	500	1280	580	280	1140	1415	860	670	Φ520	Φ525	16-Φ30	4-SD61-2.5	20
	966	268.3	10																					
	1160	322.2	8.5																					
400-500	650	180.6	23.5	81	1000	90	5	2200	1800	410	500	600	1350	580	280	1270	1600	950	770	Φ580	Φ525	16-Φ30	4-SD61-2.5	20
	1080	300	20.5																					
	1300	361	18																					
400-500A	560	155.6	17	80	1000	75	5	2200	1800	410	500	600	1350	580	280	1210	1550	890	770	Φ580	Φ525	16-Φ30	4-SD61-2.5	20
	935	259.7	15																					
	1120	311.3	13.2																					
400-500B	560	155.6	17	78	1000	55	5	2200	1800	410	500	600	1350	580	280	1180	1460	860	770	Φ580	Φ525	16-Φ30	4-SD61-2.5	20
	935	259.7	15																					
	1120	311.1	13.2																					
400-625	650	180.6	35	82	1000	132	5	2400	1900	410	500	600	1450	630	280	1300	1690	980	770	Φ580	Φ525	16-Φ30	4-SD61-2.5	20
	1080	300	32																					
	1300	361	29																					
400-625A	600	166.7	30	81	1000	110	5	2400	1900	410	500	600	1450	630	280	1300	1690	980	770	Φ580	Φ525	16-Φ30	4-SD61-2.5	20
	996	276.7	27																					
	1200	333.3	25																					
400-625B	560	155.6	26	80	1000	90	5	2400	1900	410	600	500	1450	630	280	1260	1600	940	770	Φ580	Φ525	16-Φ30	4-SD61-2.5	20
	935	259.7	24																					
	1120	311.1	22																					

YST

Standard Centrifugal Pump



Private House



Agricultural



Civil use



Industrial use



Standard Centrifugal Pump

Structural Features

- EN733 standard centrifugal pump casing dimensions
- Cast iron pump body , flange connection
- Cast iron butt flange in accordance with ISO228/1
- Impeller: cast iron or 304 stainless steel
- Motor: Insulation class F
Protection class IP55

Operating Conditions

- Delivery: up to 220m³/h
- Head: up to 95m
- Suction: up to 7m
- Liquid Temperature : - 10 °C - 90 °C
- Ambient Temperature: - 10 °C - 40 °C
- Max. Operating Pressure: 10bar (PN 10)
- Allowed motor to operate continuously for a long time: S1

Structure

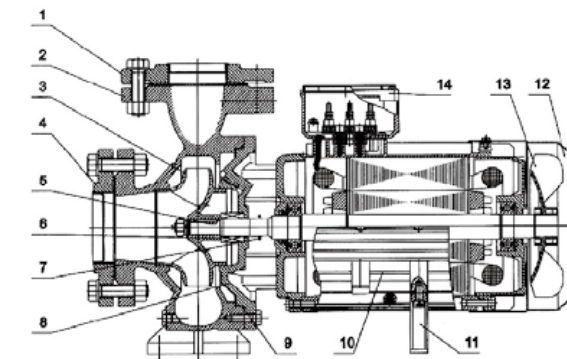

No.	Part	No.	Part	No.	Part	No.	Part
1	Outlet Flange	5	Flat Keys	9	O-Ring	13	Fan
2	Pump Body	6	Mechanical Seal	10	Motor	14	Terminal Box
3	Impeller	7	Water Retaining Ring	11	Support Foot		
4	Inlet Flange	8	Connection	12	Fan Cover		

Main Application

- Water Supply
- Pressurization
- Irrigation
- Central air conditioning circulation
- Fire water supply
- Industrial water
- Agricultural water

Model Implication

YST m 32 - 160 / 30

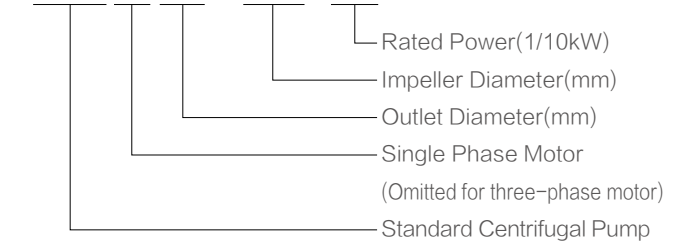

32-125 -2900r/min Performance curve

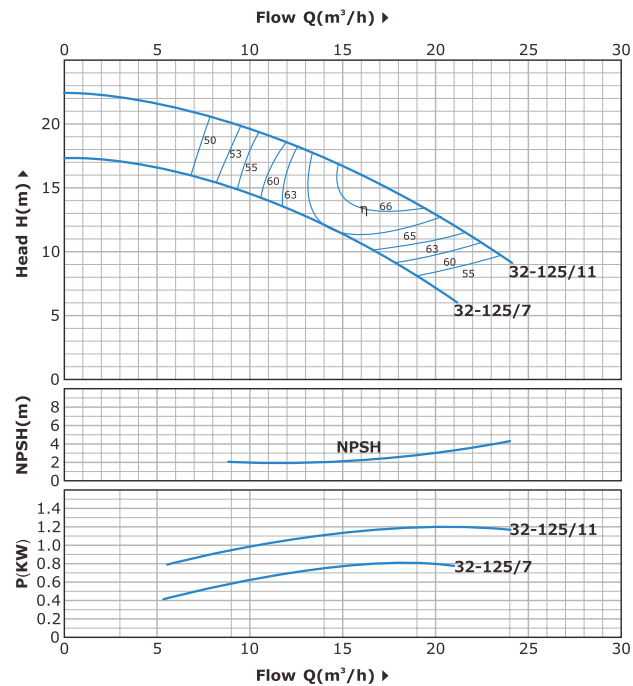

32-160 -2900r/min Performance curve

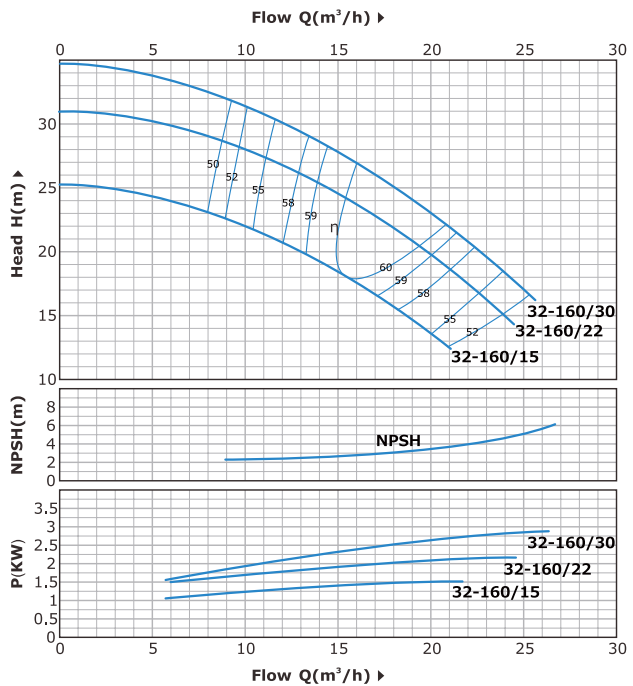

32-250D -2900r/min Performance curve

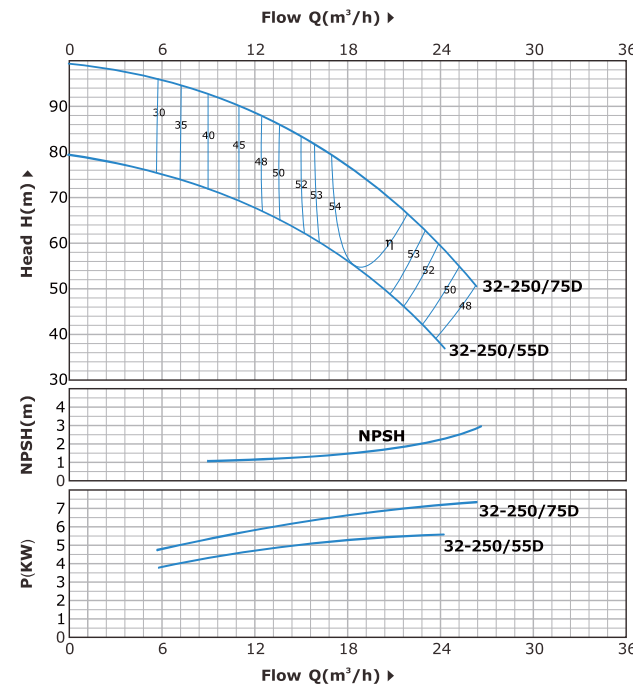

40-125 -2900r/min Performance curve

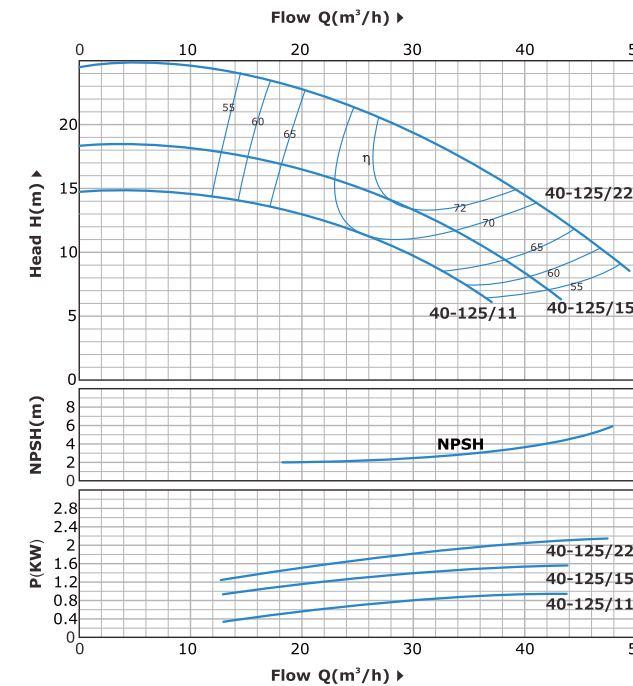

32-200 -2900r/min Performance curve

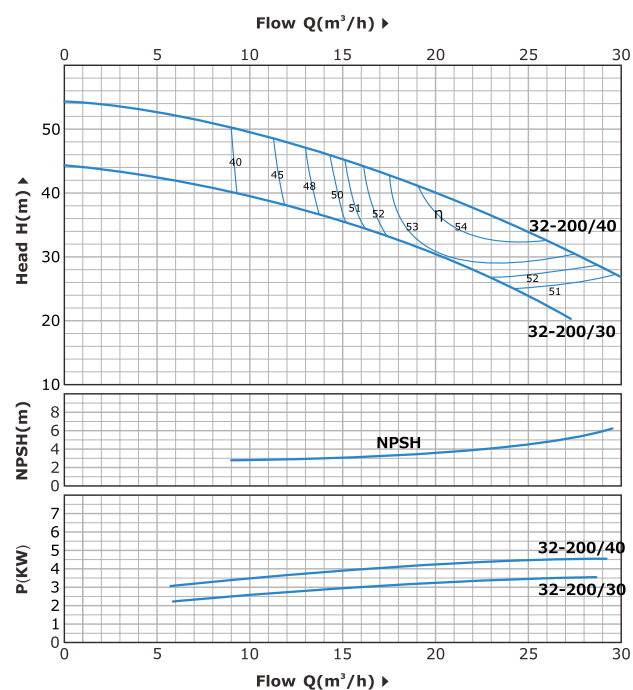

32-250 -2900r/min Performance curve

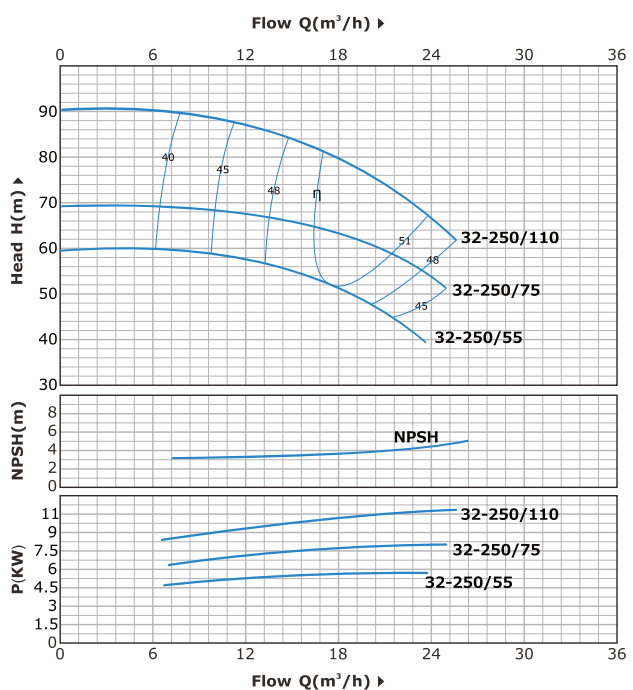

40-160 -2900r/min Performance curve

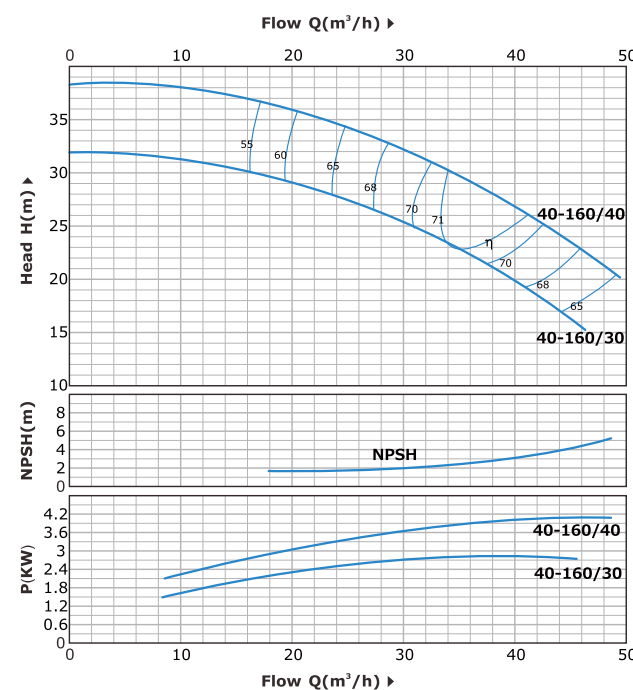

40-200 -2900r/min Performance curve

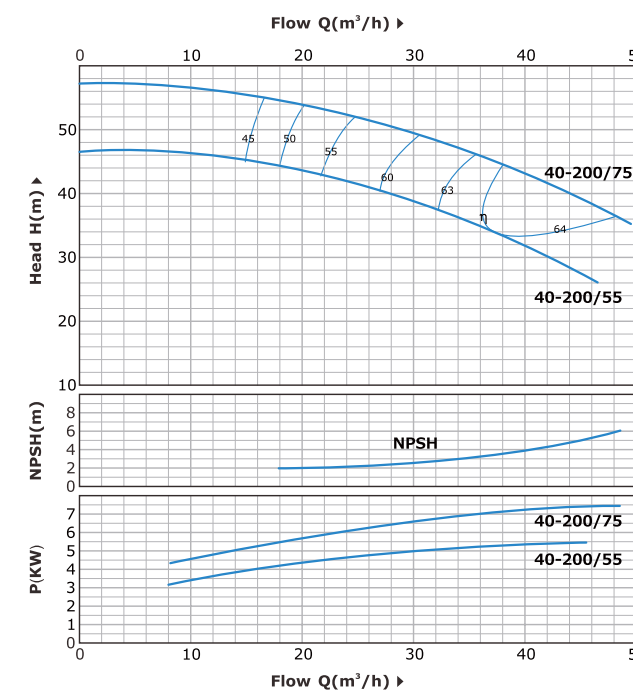

40-250 -2900r/min Performance curve

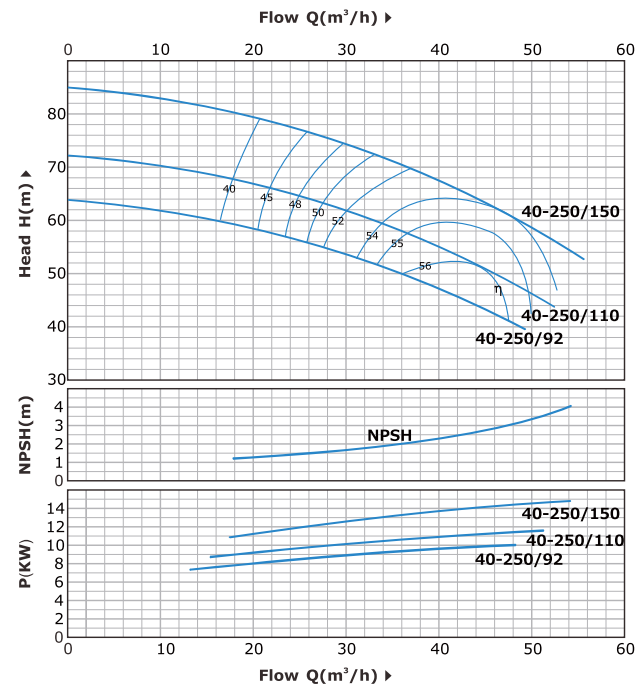

50-125 -2900r/min Performance curve

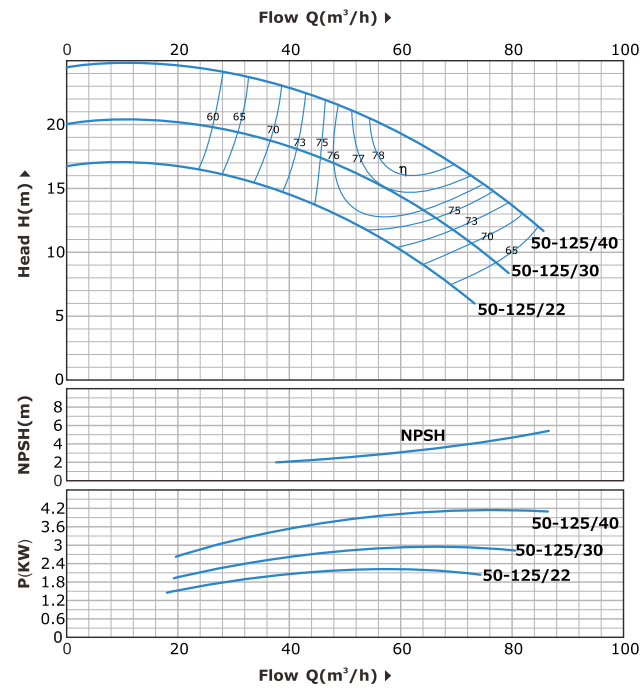

50-250 -2900r/min Performance curve

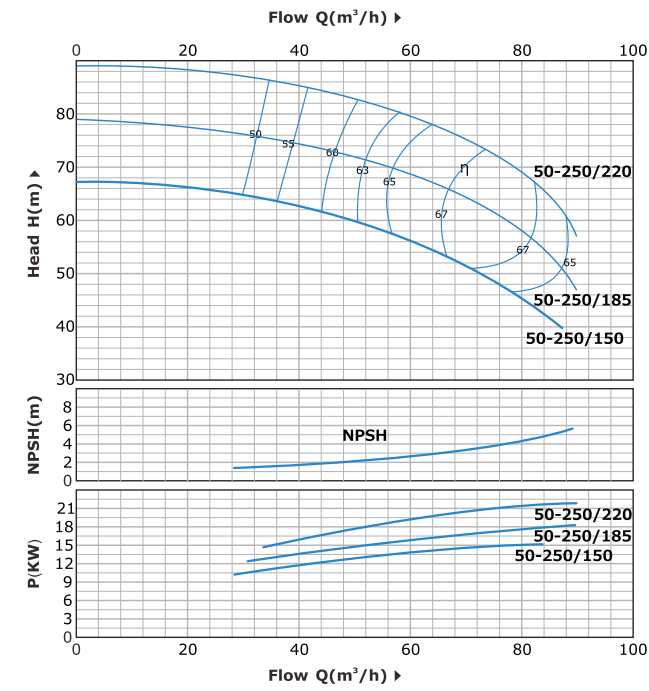

65-125 -2900r/min Performance curve

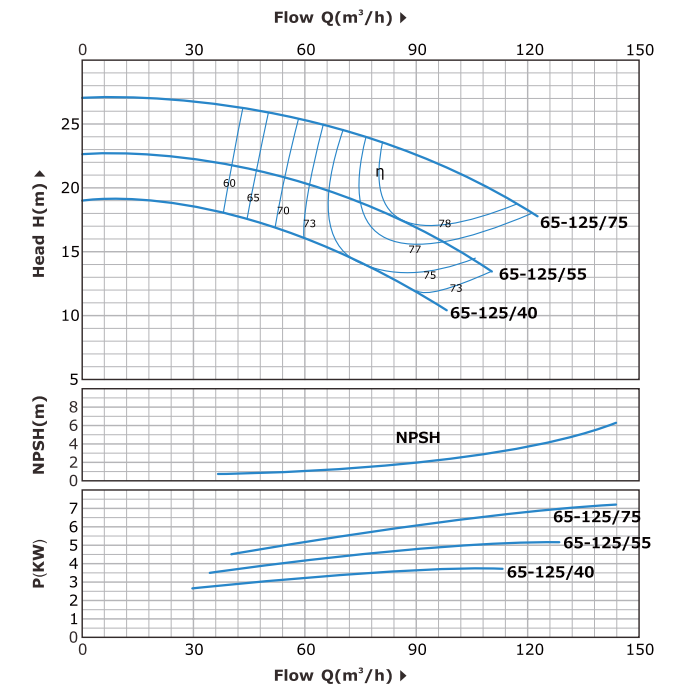

50-160 -2900r/min Performance curve

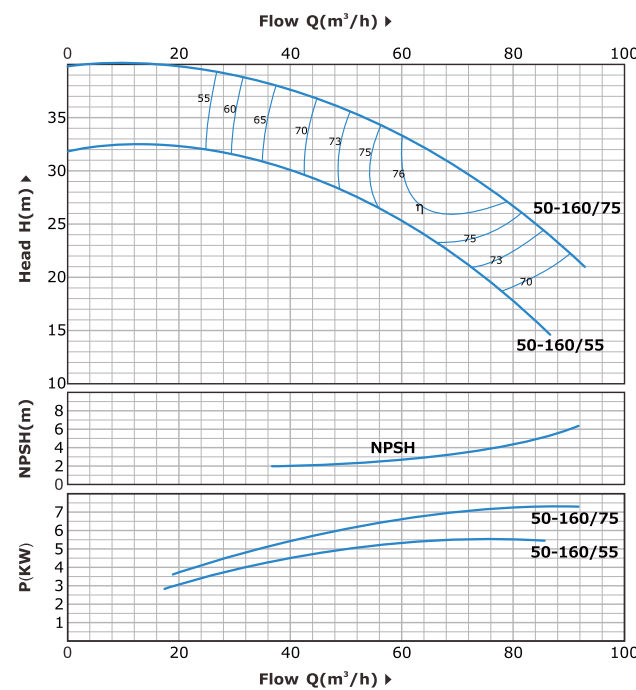

50-200 -2900r/min Performance curve

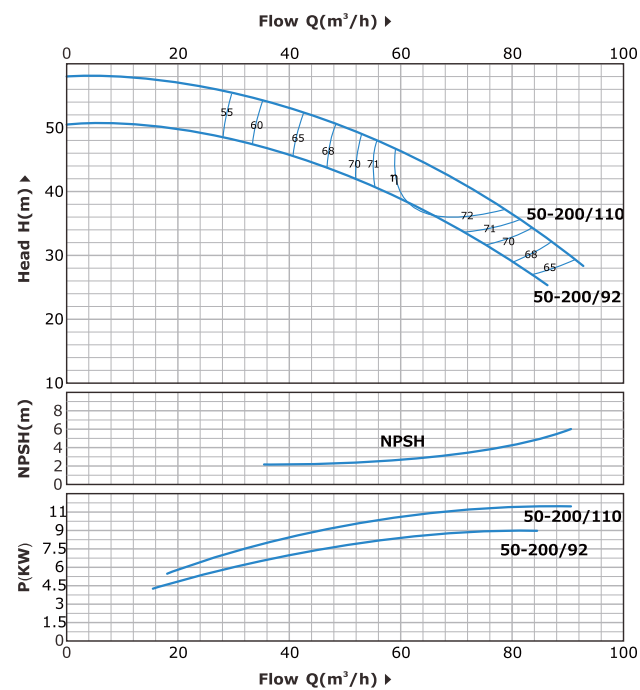

65-160 -2900r/min Performance curve

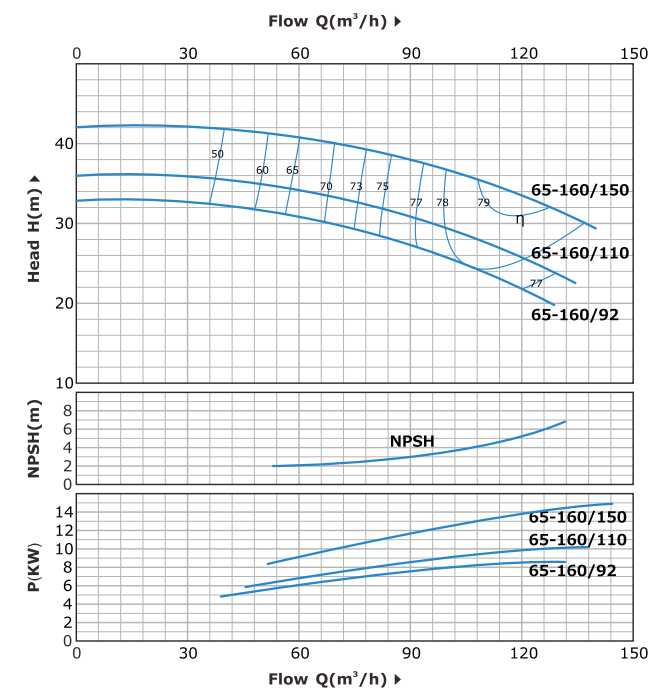

65-200 -2900r/min Performance curve

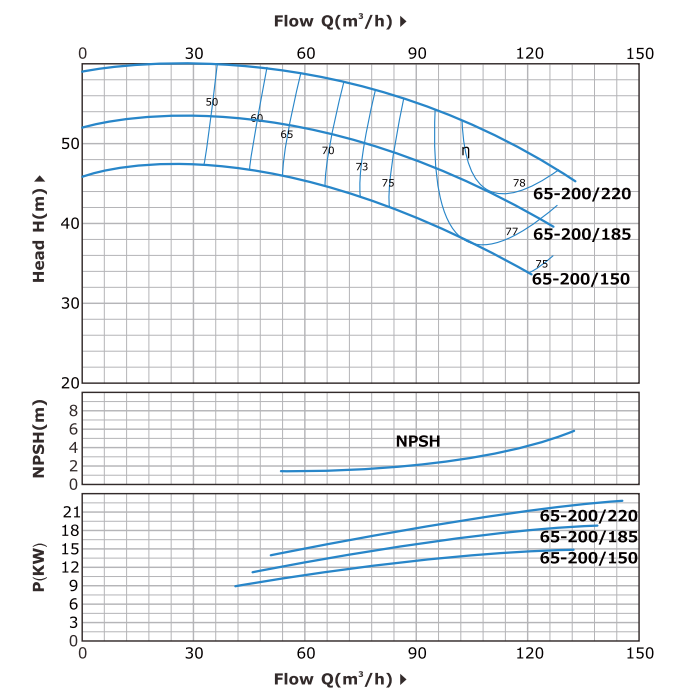

65-250 -2900r/min Performance curve

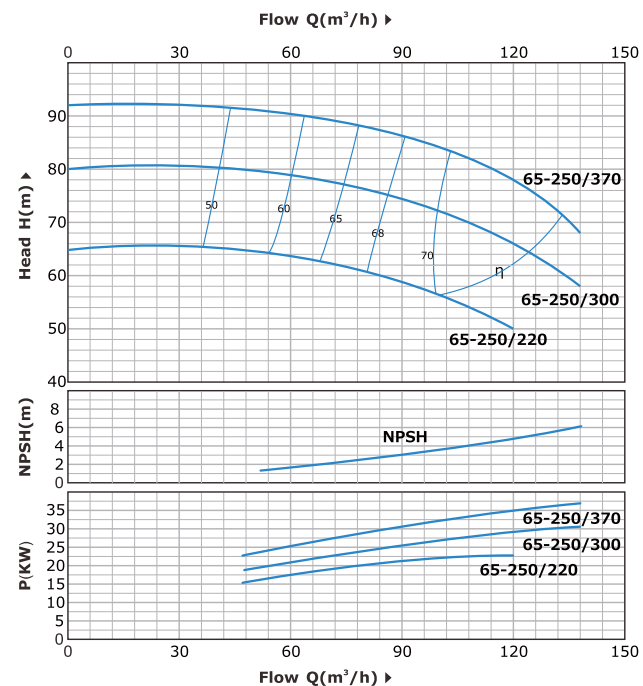

80-125 -2900r/min Performance curve

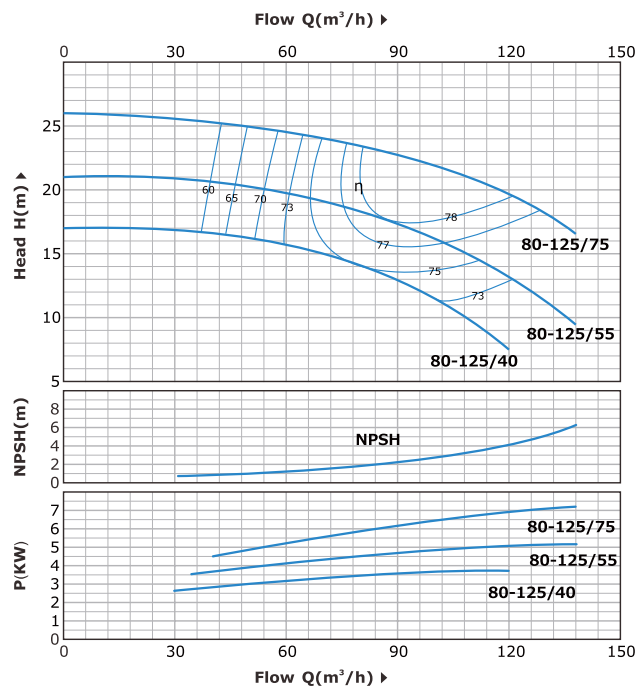

80-250 -2900r/min Performance curve

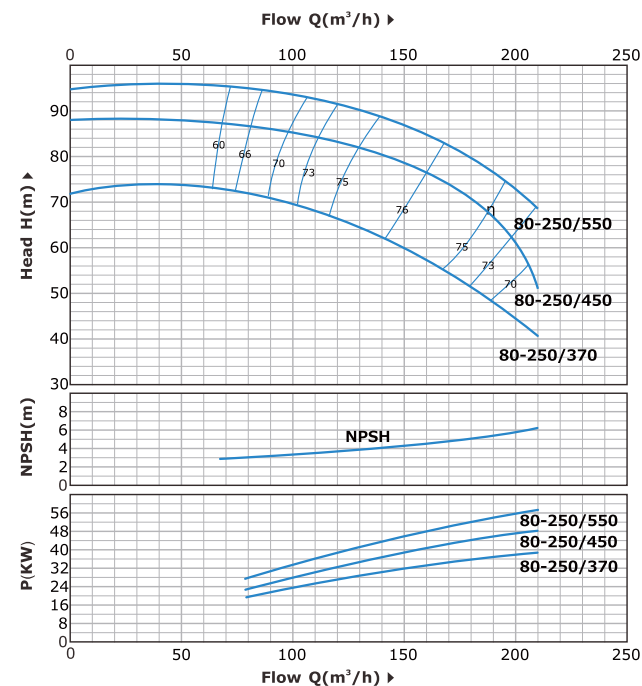

100-160 -2900r/min Performance curve

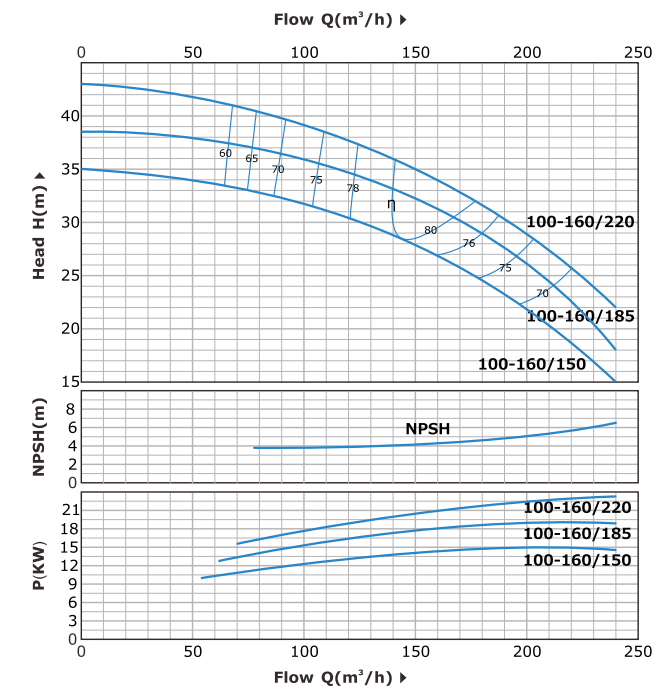

80-160 -2900r/min Performance curve

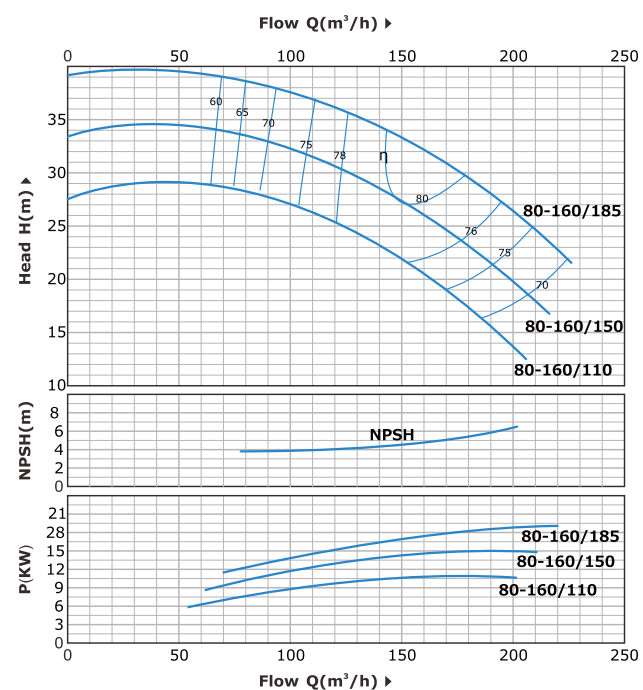

80-200 -2900r/min Performance curve

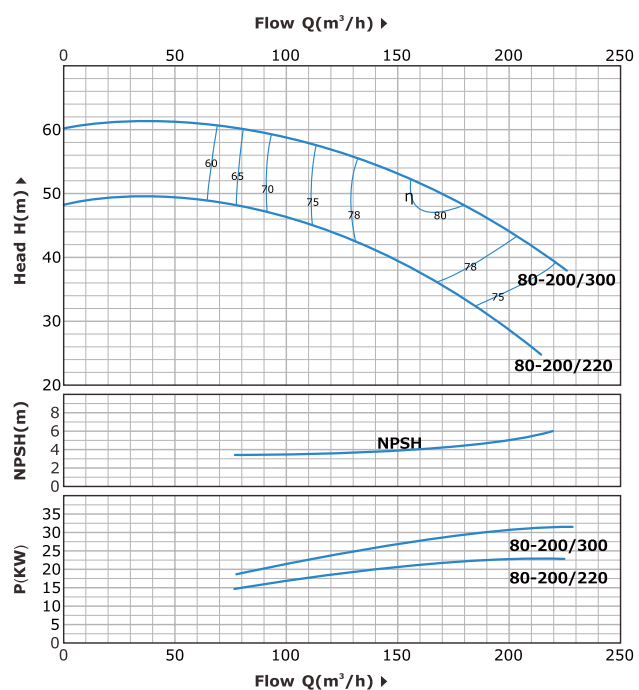

100-200 -2900r/min Performance curve

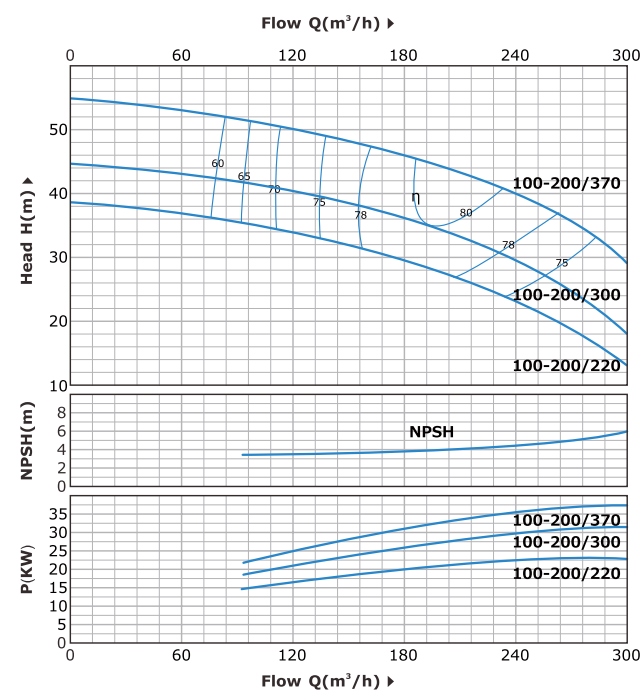

100-250 -2900r/min Performance curve

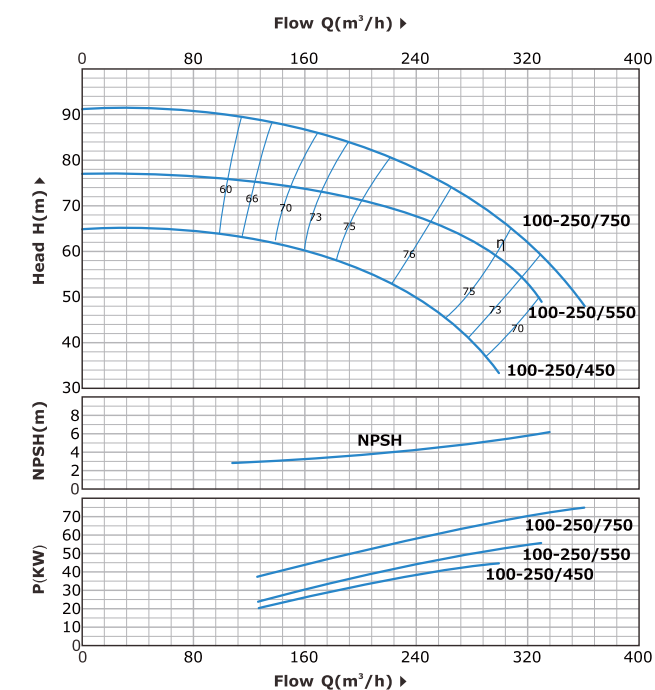

Installation Dimension

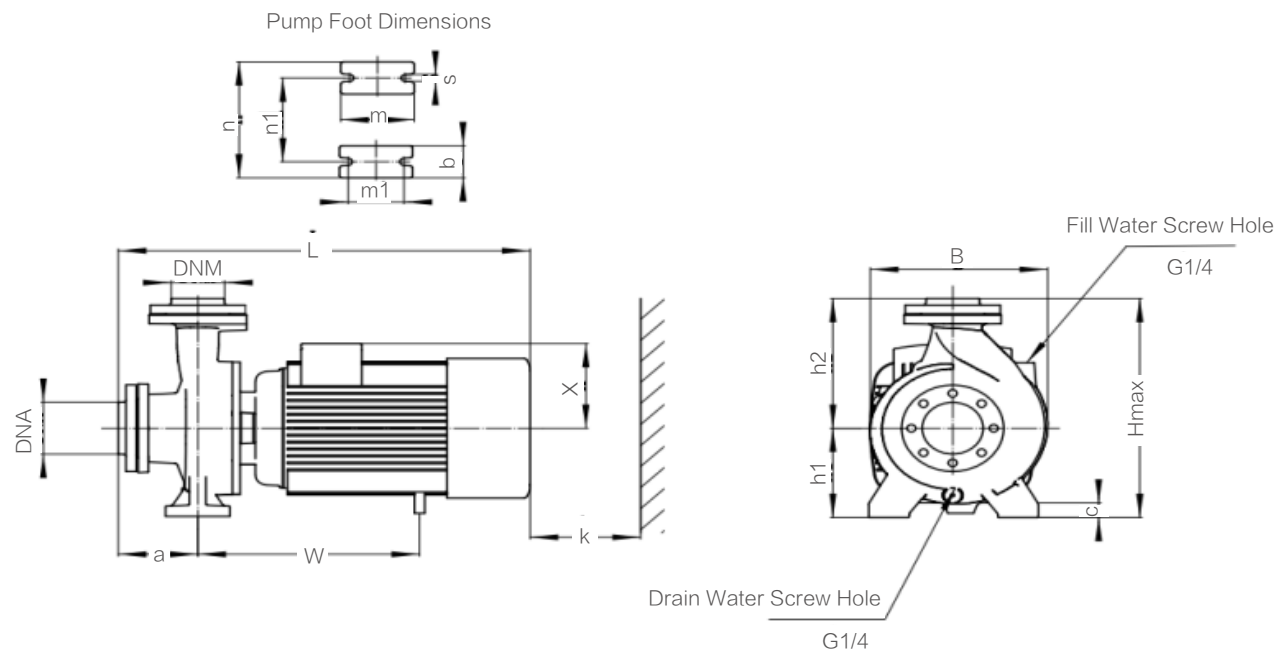

Model	DNA	DNM	Dimensions(mm)										Weight kg
			m	m1	n	n1	s	h1	a	L	W	H	
YST32-125/07	50	32	100	70	190	140	14	112	80	406	195	250	27
YST32-125/11													28
YST32-160/15													35
YST32-160/22			100	70	250	190	14	161	83	445	255	295	37
YST32-160/30													41
YST32-200/30													51
YST32-200/40			125	95	330	250	17	185	88	615	330	405	53
YST32-250/55													76
YST32-250/75													78
YST32-250/92													117
YST32-250/110													132
YST32-250/150													138
YST40-125/11	65	40	100	70	225	160	15	115	82	450	225	260	36
YST40-125/15													38
YST40-125/22													40
YST40-160/30			100	70	240	190	15	134	82	505	245	305	47
YST40-160/40													49
YST40-200/55													64
YST40-200/75			100	70	270	212	15	160	102	565	270	340	69
YST40-250/9.2													117
YST40-250/110													132
YST40-250/150													138
YST40-250/185													156
YST40-250/185													156

Model	DNA	DNM	Dimensions(mm)										Weight kg		
			m	m1	n	n1	s	h1	a	L	W	H			
YST50-125/22	65	50	100	70	255	190	15	135	105	574	255	305	49		
YST50-125/30													51		
YST50-125/40													54		
YST50-160/40			100	70	280	212	15	162	105	574	280	345	63		
YST50-160/55													64		
YST50-160/75													71		
YST50-200/92			125	95	310	230	17	185	105	656	315	390	110		
YST50-200/110													125		
YST50-200/150													143		
YST50-250/150			125	95	330	250	17	185	101.5	730	327	415	143		
YST50-250/185													156		
YST50-250/220													164		
YST65-125/40	80	65											125	95	280
YST65-125/55			71												
YST65-125/75			73												
YST65-160/92			125	95	310	230	15	185	111	646	315	415	100		
YST65-160/110													122		
YST65-160/150													137		
YST65-200/150			125	95	310	230	15	185	111	743	340	425	145		
YST65-200/185													158		
YST65-200/220													165		
YST65-250/220													195		
YST80-125/40			100	80	125	95	280	212	15	163	118	595	285	357	66
YST80-125/55															72
YST80-125/75	74														
YST80-160/110	125	95			330	250	17	186	120	656	340	435	128		
YST80-160/150													145		
YST80-160/185													156		
YST80-160/220	130	95			330	240	15	200	119	750	340	460	165		
YST80-200/220													208		
YST100-160/150													125	100	125
YST100-160/18.5	157														
YST100-160/220	166														
YST100-200/220	210														
YST100-200/220	210														

Installation Dimension

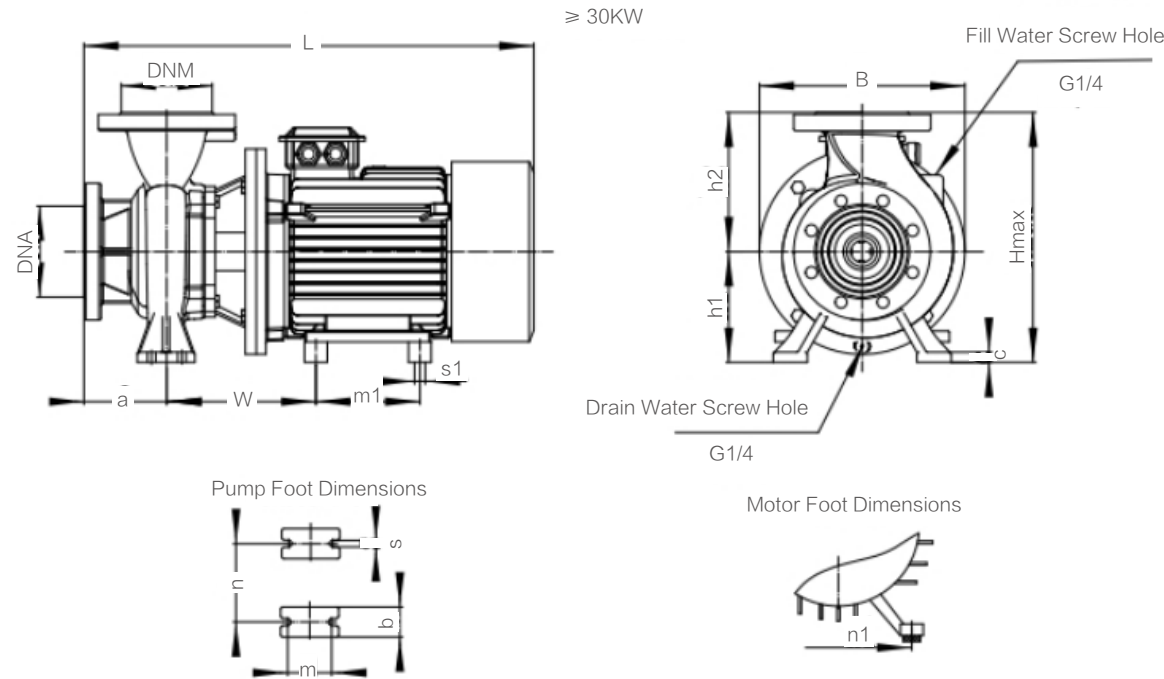

Model	DNA	DNM	Dimensions(mm)											Weight kg			
			m	n	s	m1	n1	s1	w	a	L	W	h1		Hmax		
YST65-250/300	80	65	95	250	17	279	279	14.5	225	116	844	355	200	467	265		
YST65-250/370											892				285		
YST80-200/300	100	80	95	240	15	279	279	14.5	218	119	840	355	200	467	262		
YST80-200/370											888				289		
YST100-200/300	125	100	95	250	15	279	279	14.5	218	125	846	355	180	467	267		
YST100-200/370											894				287		
YST65-315/450	80	65	120	315	18	311	356	18.5	274	125	1108	450	225	547	371		
YST65-315/550						349	406	24	343		1238				638	450	
YST65-315/750						368	457	24	365		1332				550	667	582
YST65-315/900						419	457	24	365		1383				667	617	
YST80-250/450	100	80	120	315	18	311	356	18.5	274	125	1108	450	200	547	362		
YST80-250/550						349	406	24	343		1238				550	638	441
YST80-250/750						368	457	24	365		1332				667	580	
YST80-315/550	100	80	120	315	18	349	406	24	343	125	1238	550	250	547	460		
YST80-315/750						368	457	24	365		1332				638	592	
YST80-315/900						419	457	24	365		1383				667	627	
YST100-250/450						125	100	120	315		18				311	356	18.5
YST100-250/550	349	406	24	348	1258					638		445					
YST100-250/750	368	457	24	370	1352					550		667	577				
YST100-250/900	419	457	24	370	1403					667		612					
YST125-200/450	150	125	120	315	18	311	356	18.5	289	140	1138	450	250	547	378		
YST125-200/550						349	406	24	358		1268				638	457	
YST125-200/750						368	457	24	380		1362				667	589	
YST125-250/550						349	406	24	358		1268				638	457	
YST125-250/750	150	125	120	315	18	368	457	24	380	140	1362	550	250	638	457		
YST125-250/900						419	457	24	380		1413				667	624	

Counter Flange

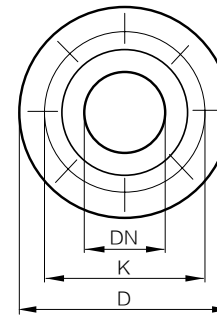

DN	D (mm)	K (mm)	Holes	
			N	Φ mm
32	140	100	4	18
40	150	110		
50	165	125		
65	185	145		
80	200	160	8	
100	220	180		
125	250	210		

Pipe Recommend

Series	Suction (mm)	Discharge (mm)	Pipe Recommend	
			Suction	Discharge
32	50	32	2 1/2" - 3"	2" - 2 1/2"
40	65	40	3" - 4"	2 1/2" - 3"
50	65	50	4"	3"
65	80	65	5"	4"
80	100	80	6"	5"
100	125	100	8"	6"



YS/YSM/YSM

End Suction Centrifugal Pump



Clean



Agricultural



Civil use



Fire

YSM

YSM

YS



Submersible Sewage Pump



Product Summary

- Complete range with a full series of end suction pumps
- Outstanding reliability for operation in any application
- YE3 high efficient motor, with protection IP55 class F
- Pump case with anti-corrosive coating
- Customize casting logo on the bearing house as request
- Quality NSK bearing, wear resistance mechanical seal

Operating Conditions

- Liquid temperature between -10°C and +120°C
- Ambient temperature between -10°C and +50°C
- Max. working pressure 20 bar
- Continuous service S1

Application

The impressive range end-suction pumps is compatible with an array of application areas, including water intake, heating, industrial pressure boosting, industrial liquid transfer, air-conditioning, district cooling, irrigation, fire fighting and many more.

Model Implication

YS(YSM/YSM) 50 - 250 / 220

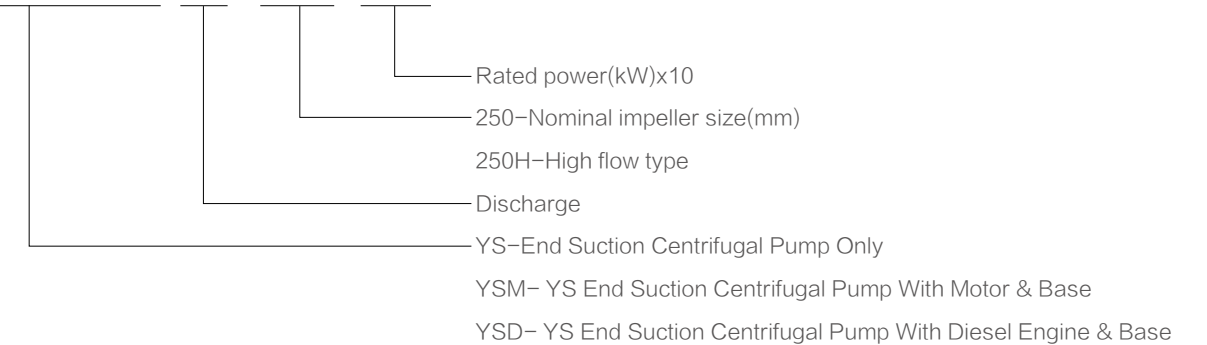

Technical Sheet

Model	YS
Capacity	0-1000 m ³ /h
Head	0-164 m
DN	32-150 mm
Speed	2900 rpm
T max	120 °C
Power	1.5-315 kW
Casing	Grey cast iron
Impeller	Cast iron/AISI 304/Brass
Shaft	45# steel/AISI 304
Shaft seal/	Mechanical seal
Bearing	Grease lubrication rolling bearing

Technical Parameter

Model	DN mm	Power		l/min m³/h	Flow Q=DELIVERY																
		kW	HP		0	400	450	500	600	700	750	833	1000	1200	1400	1500	1600	1800	2333	2500	3333
					0	24	27	30	36	42	45	50	60	72	84	90	96	108	140	150	200
YS65-160(157)/11	80x65	1.1	1.5		8	7.5	7.4	7.3	7	6.6	6.3	5.8	4.8	3.4	-	-	-	-	-	-	
YS65-160(165)/15	80x65	1.5	2		9	8.5	8.4	8.3	8	7.6	7.4	6.9	6	4.6	-	-	-	-	-	-	
YS65-160(184)/22	80x65	2.2	3		10.3	9.9	9.9	9.8	9.5	9.2	9	8.6	7.8	6.5	5	-	-	-	-	-	
YS65-200(188)/15	80x65	1.5	2		10	-	-	9.6	9.1	8.5	8.2	7.6	6.4	4.6	-	-	-	-	-	-	
YS65-200(195)/22	80x65	2.2	3		12.4	-	-	12.2	11.8	11.3	11	10.4	9.3	7.6	-	-	-	-	-	-	
YS65-200(212)/30	80x65	3	4		14.4	-	-	14.3	13.8	13.4	13.1	12.5	11.3	9.6	7.5						
YS65-250(226)/30	80x65	3	4		15.4	-	-	14.6	13.9	13.1	12.6	11.6	9.7	6.7	-	-	-	-	-	-	
YS65-250(244)/40	80x65	4	5.5		19	-	-	18.3	17.8	17.2	16.9	16.1	14.4	11.7	-	-	-	-	-	-	
YS65-250(255)/55	80x65	5.5	7.5		22.3	-	-	21.3	20.9	20.3	19.9	19.2	17.7	15.1	12	-	-	-	-	-	
YS65-315(300)/75	80x65	7.5	10		26.5	-	-	-	25.6	25.2	24.9	23	20.8	17.6	-	-	-	-	-	-	
YS65-315(322)/110	80x65	11	15		34.8	-	-	-	34.2	33.9	33.7	33.2	32.1	30.2	27.4	25.6	23.7	18.7	-	-	
YS65-315(328)/150	80x65	15	20		40	-	-	-	39.4	39.1	38.9	38.4	37.3	35.4	32.6	30.8	28.9	23.9	-	-	
YS80-160(168)/15	100x80	1.5	2	H (m)	7.5	-	-	-	-	7.1	6.9	6.4	5.5	4.6	4.1	3.5	-	-	-	-	
YS80-160(182)/22	100x80	2.2	3		9	-	-	-	-	8.6	8.4	8	7.4	6.6	6.2	5.7	5	-	-	-	-
YS80-200(191)/30	100x80	3	4		11.8	-	-	-	-	11	10.7	10.1	9.2	8	7.3	6.6	-	-	-	-	-
YS80-200(217)/40	100x80	4	5.5		14.2	-	-	-	-	13.8	13.6	13.3	12.4	11.3	10.7	10	9	-	-	-	-
YS80-250(240)/55	100x80	5.5	7.5		20.5	-	-	-	-	19.5	19.1	18.4	17.2	15.5	14.5	13.5	11.1	-	-	-	-
YS80-250(258)/75	100x80	7.5	10		24	-	-	-	-	23.5	23.2	22.5	21.3	19.9	19	18.1	16	-	-	-	-
YS80-250(276)/110	100x80	11	15		28.2	-	-	-	-	27.5	27.2	26.5	25.3	23.9	23	22.1	20	15	-	-	-
YS80-315(255)/55	100x80	5.5	7.5		19.7	-	-	-	-	19.1	18.8	18.1	16.8	15	13.9	12.8	10.1	-	-	-	-
YS80-315(270)/75	100x80	7.5	10		24.6	-	-	-	-	23.9	23.6	23	21.9	20.4	19.5	18.6	16.3	-	-	-	-
YS80-315(290)/110	100x80	11	15		29.9	-	-	-	-	29.4	29.2	28.8	28.1	27	26.3	25.5	23.6	16.5	13.5	-	-
YS80-315(328)/150	100x80	15	20		36.8	-	-	-	-	36.4	36.1	35.6	34.7	33.6	33	32.4	30.9	25.3	23	-	-
YS100-160(178)/22	125x100	2.2	3		5.9	-	-	-	-	5.8	5.7	5.5	5.3	5	4.9	4.6	4.3	-	-	-	-
YS100-200(188)/30	125x100	3	4		8.2	-	-	-	-	8.1	8	7.9	7.6	7.3	7.2	6.9	6.5	5.1	-	-	-
YS100-200(185)/40	125x100	4	5.5		11.5	-	-	-	-	11.5	11.4	11.2	10.9	10.6	10.5	10.2	9.8	8.4	7.8	-	-
YS100-200(197)/55	125x100	5.5	7.5		13.3	-	-	-	-	13.2	13.2	13	12.7	12.4	12.3	12	11.5	9.6	8.8	5.7	-
YS100-250(240)/75	125x100	7.5	10		19.5	-	-	-	-	19.5	19.4	19.2	18.8	18.3	18.1	17.6	16.9	14	12.7	-	-
YS100-250(257)/110	125x100	11	15		24.3	-	-	-	-	24.3	24.2	24.1	23.7	23.3	23.1	22.7	22.1	19.7	18.6	11.4	-
YS100-250(250)/150	125x100	15	20		27.8	-	-	-	-	27.8	27.7	27.6	27.2	26.8	26.6	26.2	25.6	23.2	22.1	14.9	-

Technical Parameter

Model	DN mm	Power		l/min m³/h	Flow Q=DELIVERY																
		kW	HP		0	500	583	667	833	1000	1500	1667	1833	2333	2500	3333	4167	5000	6667	8333	10000
					0	30	35	40	50	60	90	100	110	140	150	200	250	300	400	500	600
YS125-200(190)/55	150x125	5.5	7.5		11.4	11.1	11.1	11	10.9	10.8	10.2	10	9.7	8.9	8.6	6.9	-	-	-	-	
YS125-200(205)/75	150x125	7.5	10		14.1	13.9	13.8	13.8	13.7	13.6	13.1	12.9	12.7	11.9	11.6	9.6	-	-	-	-	
YS125-200(218)/110	150x125	11	15		18.1	17.9	17.8	17.7	17.6	17.1	16.9	16.7	15.9	15.6	13.6	9.8	-	-	-	-	
YS125-250(215)/75	150x125	7.5	10		15.4	-	-	-	-	15.3	15	14.8	14.6	13.6	13.1	-	-	-	-	-	
YS125-250(240)/110	150x125	11	15		19.4	-	-	-	-	19.3	19.1	19	18.9	18.1	17.8	15.3	11.7	-	-	-	
YS125-250(265)/150	150x125	15	20		23.4	-	-	-	-	23.3	23.1	23	22.9	22	22	19.8	16.5	12.3	-	-	

YSC

Split-Case Pump



Agricultural



Civil use



Industrial use



Split-Case Pump



Product Overview

YSC series pump is a single-stage, double-suction, open-shell, horizontal centrifugal pump, which is used to pump untreated water, clean water, nonpotable water, and hydrocarbons. The maximum temperature of the pumped liquid can reach 105°C. YSC (L) series pump has a flow rate of 68–18000 m³/hour and a head of 7–200 m, suitable for tap water, irrigation, drainage pumping stations, power stations, industrial water supply systems, fire protection systems, shipbuilding industry. It is also suitable for general use in oil refining industry.

Model Implication

YSC (L) 80 – 270 A

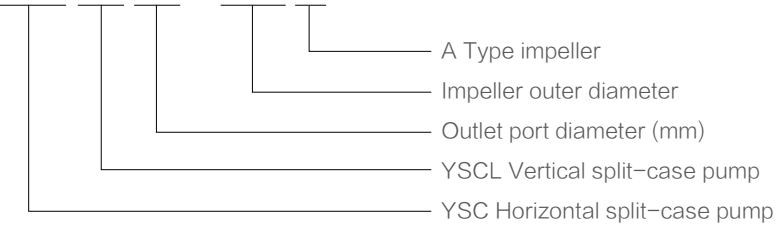

Technical Parameter

Model	Flow Range m ³ /h	Head m	Speed r/min	Power Range kW	Eff. %	NPSH mm	
80-210A	131	60.5	2900	26.8	80.6	5.1	
	164	55		29.9	82.0		
	197	50		33.4	80.2		
	80-210B	121	52	2900	21.6	79.3	4.6
		151	47.5		24.1	81.0	
		181	42.2	26.1	80.0	4.5	
		115	44	17.8	77.8		
		144	39	2900	19		80.5
		173	35	21.1	78	4.3	
	110	37	14.7	75.3			
	137	33.5	2900	16	77.5		
	80-210B	164	27.7	16.7	74.0	4.0	
107		55.5	20.5	79			
134		51	2900	22.9	81		
80-210B		160	46	25.1	80.1	4.0	
		106	47.7	17.6	78.2		
		133	43.5	2900	19.3	80	
		159	37	20	80.1	3.7	
		100	40	14.4	75.5		
		124	36	2900	15.6		78.2
80-210B		149	30	16.5	74	3.5	
		91	35	12.1	71.5		
		113	31	2900	12.9	74	
	136	27	13.9	72	5.1		

Model	Flow Range m ³ /h	Head m	Speed r/min	Power Range kW	Eff. %	NPSH mm	
80-270A	166	97.5	2900	57	77.2	7.0	
	207	90		64.6	78.5		
	248	79		70.8	75.5		
	80-270B	156	83.5	2900	46.6	76	6.0
		194	77		52.6	77.5	
		233	69	58.1	75.5	5.3	
		147	70	37.5	74.7		
		184	63.5	2900	41.8		76
		80-270B	220	55	44.6	74	7.3
	138		56.5	28.7	74.2		
	173		50	2900	31.4	75	
	80-270B		198	45	32.8	74	6.0
137			91	44.6	76.1		
171			82.5	2900	49.9	77	
205			72.5	54.1	75	6.0	
122			79.5	35.6	74.4		
153			71.5	2900	39.1	76.2	
80-270B	184		67	44.7	76	5.5	
	115		66.8	28.5	73.7		
	144		60	2900	31.3		75.2
	80-270B	173	53	33.7	74.2	5.4	
		110	54.5	22.4	72.5		
		137	49	2900	24.5	74.4	
164	42	25.9	72.5				

Technical Parameter

Model	Flow Range m³/h	Head m	Speed r/min	Power Range kW	Eff. %	NPSH mm		
80-270B	68	23.1	1450	5.7	75.8	2.4		
	85	20.7		6.2	77			
	102	18.2		6.7	75.4			
	80-270B	61	20	1450	4.5	74.5	2.2	
		77	18.1		5.0	76		
		92	16		5.3	75		
		80-270B	58	16.5	1450	3.5	73	2.1
			72	15		3.9	75	
			86	13.2		4.2	74	
	53		13.8	2.7		72		
	80-270B	67	12.5	1450	3.1	74	2.1	
		80	10.8		3.2	73		
80-270B		90	42	1450	14.8	70.2	2.8	
		113	38.8		16.2	75		
		136	33.5		17.3	71.8		
80-370A		80	35	1450	10.6	71	2.3	
		99	33		12.1	72.2		
		120	29.1		13.3	71		
	80-370A	70	29.3	1450	8.2	68.4	2.3	
		88	27.5		9.4	70		
		106	24.7		10.2	68.3		
		65	23.8		6.4	66		
	80-370A	81	22.5	1450	7.4	67.5	2.3	
		98	20		8.0	65.5		
		80-370B	80	38.8	1450	11.8	71	3.0
99			35.5	13.1		73		
120			31.3	14.3		71		
80-370B	72	34.1	1450	9.7	69	2.6		
	90	30.8		10.8	70			
	108	26.3		11.4	68			
	80-370B	60	27.5	1450	7.0	64.5	2.3	
		76	25.5		8.0	66		
		90	22.5		8.5	65.2		
		53	21.3		4.9	63		
	80-370B	67	20	1450	5.7	64	2.3	
		80	17.5		6.0	63		
		100-250A	115	21.2	1450	8.2	80.7	2.9
144			18.8	8.9		83		
173			17.5	10		81.7		
100-250A		112	17.5	1450	6.7	79	2.9	
		140	15.8		7.4	81		
		167	13.2		7.7	77		
	100-250A	100	14.5	1450	5.1	77.8	2.9	
		126	13.5		5.9	79		
		150	11.9		6.3	77.6		
		97	12.2		4.2	75.5		
	100-250A	120	11.2	1450	4.7	77.5	2.9	
		145	9.5		5.0	75.5		

Model	Flow Range m³/h	Head m	Speed r/min	Power Range kW	Eff. %	NPSH mm		
100-250B	98	18.8	1450	6.2	80.5	2.9		
	122	17		7.0	91.5			
	147	15		7.6	79.5			
	100-250B	90	16.3	1450	5.1	78	2.3	
		112	14.5		5.6	79.5		
		135	12.7		6.0	77.2		
		100-250B	85	13.7	1450	4.1	77	2.2
			106	12.5		4.7	78	
			128	11.3		5.3	75	
	75		12.1	3.3		75		
	100-250B	94	11	1450	3.7	76	2.1	
		113	9.6		3.9	75.2		
100-250B		148	34	1450	17.4	78.5	3.1	
		185	31		19.6	80		
		222	26.8		21	77.2		
100-310A		133	29.3	1450	13.4	79	2.7	
		166	27		15.3	79.6		
		200	24.3		17	77.4		
	100-310A	120	24.8	1450	10.5	78	2.5	
		151	22.5		11.7	79.3		
		180	20		12.8	77.4		
		112	20.2		7.9	77.8		
	100-310A	140	18.5	1450	9.0	79	2.3	
		162	16.2		9.2	78		
		100-310B	112	32.5	1450	13	76.6	2.7
140			29.5	14.1		78		
168			25	15.5		74		
100-310B	106	27.5	1450	10.4	76.6	2.5		
	133	25.5		11.6	77.6			
	160	22		12.8	75			
	100-310B	100	23	1450	8.2	76.2	2.4	
		124	21.2		9.0	77.3		
		150	18		9.8	75		
		94	19.4		6.5	76.5		
	100-310B	117	17	1450	6.9	77	2.3	
		140	15		7.6	76		
		100-375A	148	57	1450	31.4	73	3.0
185			51	33.5		76.5		
220			44.2	36		74		
100-375A		133	47.3	1450	24.5	71	2.7	
		167	46		28.3	74		
		200	38		29.2	72.3		
	100-375A	124	41	1450	20.3	67.5	2.5	
		155	38		22.6	71		
		186	31		23.1	68		
		108	32.5		14.4	66.3		
	100-375A	135	30.3	1450	14.5	69	2.1	
		162	25.3		16.8	66.5		

Technical Parameter

Model	Flow Range m³/h	Head m	Speed r/min	Power Range kW	Eff. %	NPSH mm		
100-375B	130	56.2	1450	28.4	70	3.6		
	162	52		31.4	72			
	195	45.8		25.9	67.5			
	100-375B	114	47.5	1450	22.2	66.5	3.3	
		142	44		23.7	69		
		170	39		27.3	66.5		
		100-375B	105	40	1450	17.7	64.5	3.0
			130	37.5		18.8	66.5	
			157	32.5		21.7	64	
	92		30.8	12.7		61		
	100-375B	115	28.7	1450	14.3	63	2.3	
		138	25		15.4	61.2		
100-375B		220	17	1450	12.1	84	2.3	
		274	14.8		12.9	85.5		
		328	12		13.1	82		
125-230A		193	15	1450	9.7	81	2.2	
		241	13.2		10.3	84.5		
		290	10.8		10.4	82		
	125-230A	184	12.6	1450	8.0	79.4	2.2	
		230	10.6		8.1	82.5		
		277	8.0		8.1	76		
		167	10.3		6.4	73		
	125-230A	209	8.7	1450	6.4	77.5	2.7	
		250	6.8		6.4	73		
		125-230B	190	17	1450	10.5	84.1	2.7
238			15.1	11.6		84.5		
307			11.5	12		80		
125-230B	170	15	1450	8.6	81	2.6		
	212	13.5		9.3	84			
	255	11.4		9.7	82			
	125-230B	164	13	1450	7.5	78	2.7	
		205	11.5		7.8	82		
		246	9.2		7.9	78		
		156	10.5		5.9	75		
	125-230B	195	9.1	1450	6.2	78	2.7	
		223	7.7		6.3	74		
		125-290A	215	29.2	1450	20.8	82.3	2.4
269			27	23.6		84		
323			23.5	25.2		82		
125-290A		195	24.4	1450	16.1	80.3	2.4	
		243	22		17.8	82		
		292	19.6		19.5	80		
	125-290A	178	20	1450	12.3	79	2.3	
		223	18		13.7	80		
		268	15.5		14.4	78.3		
		161	16.3		9.3	77		
	125-290A	202	14.2	1450	10	78	2.3	
		242	11.8		10.2	76.2		

Model	Flow Range m³/h	Head m	Speed r/min	Power Range kW	Eff. %	NPSH mm		
125-290B	193	27.5	1450	17.8	81	2.4		
	241	25		19.8	83			
	290	21.3		20.6	80			
	125-290B	174	23.4	1450	13.9	80	2.3	
		218	21		15.2	82		
		261	17.5		16	78		
		125-290B	157	19	1450	10.4	78	2.2
			196	17.5		11.8	79	
			235	15		12.3	78	
	135		15.1	7.7		74.3		
	125-290B	173	13.7	1450	8.5	76	2.2	
		207	11.3		8.6	74		
125-290B		245	50	1450	41.2	82	2.6	
		310	47		47.2	84		
		360	44		52.3	82		
125-365A		225	41.6	1450	31.8	80	2.8	
		281	39		36	83		
		337	35.6		40.4	81.2		
	125-365A	205	33.7	1450	24.2	76	2.9	
		256	31.5		26.8	82		
		307	28.2		29.8	79.5		
		1847	25.5		16.9	76		
	125-365A	230	24	1450	18.8	80	3.0	
		278	20.9		20.2	78		
		125-365B	222	46.3	1450	35.4	79.5	2.9
277			43	40.1		81		
333			38.8	44		80		
125-365B	202	39.8	1450	28	78.5	2.8		
	252	37		31.8	80			
	302	32.8		34.2	79			
	125-365B	182	32.6	1450	21.4	76.5	2.8	
		227	30.5		24.5	78.5		
		272	27.5		26.8	76		
		158	26.3		14.9	77.8		
	125-500A	198	24.5	1450	17.4	78	2.7	
		238	21.8		18.8	75.2		
		125-500A	262	82	1450	73.7	79.5	2.8
328			76	82.7		82		
393			70	96.4		77.8		
125-500A		233	70	1450	56.7	78.5	2.7	
		292	66.5		67.3	80		
		342	62		74.8	77.2		
	125-500A	205	60	1450	44	76	2.5	
		256	56		50.6	77		
		307	51.5		56.6	76		
		184	50		34.2	73.5		
	125-500A	230	47	1450	38.8	76.5	2.5	
		252	45		40.7	76		

Technical Parameter

Model	Flow Range m³/h	Head m	Speed r/min	Power Range kW	Eff. %	NPSH mm			
125-500B	235	75	1450	61.7	77.7	3.2			
	293	69.5		70.3	79				
	352	63		78.5	77				
	125-500B	217	65	1450	50.1	76.8	2.9		
		272	60.5		57.4	78			
		236	55		64.3	76			
		125-500B	181	57	1450	37.5	75.1	2.6	
			227	53		42.5	77		
			272	48.3		47.3	75.8		
	125-500B	161	47.5	1450	28.2	74	2.5		
		202	45		32.5	76			
		234	40		34.5	74			
150-290A		354	24		1450	27.1		85.6	2.9
		443	21			29.1		87	
	543	17.5	30.3	83.5					
	323	21	22.2	83					
150-290A	403	18	1450	23	86	2.9			
	484	15		24	82.3				
	302	17.5		18	80				
	150-290A	378	15	1450	18.4	84	2.9		
		454	12.3		19.1	79.4			
		280	13.7		13.9	75			
	150-290A	350	11.5	1450	14.2	77	3.0		
396		10	14.2		76				
150-290B		317	23.4		1450	24		84.2	3.0
		396	20.4			25.6		86	
		475	16.6			25.7		83.5	
150-290B	302	20	1450	19.9	82.8	3.1			
	378	17		20.6	85				
	454	13.7		20.7	82				
	282	17.5		16.6	80.6				
	150-290B	353	14.5	1450	16.6	84	3.1		
		423	11.3		16.5	79			
		265	14		13	76.7			
		331	11.5		13	80			
150-360A	378	9.8	1450	13.3	76	3.1			
	150-360A	357		41.3	1450		48.4	83	3.0
		446		38			54.3	85	
		536		34.2			60.4	82.7	
	150-360A	323		34.2	1450		36.9	81.5	3.0
		403		31			41	83	
		484		26.3			42.9	80.8	
		298		28.7			29.4	79	
		370		25			31.2	81	
	150-360A	445		21	1450		32.3	78.8	3.0
		265		23.4			22.1	76.5	
331		20	23.1	78					
398		16.7	23.3	77.6					

Model	Flow Range m³/h	Head m	Speed r/min	Power Range kW	Eff. %	NPSH mm			
150-360B	325	39.2	1450	42.3	82.1	3.0			
	107	35		46.2	84				
	488	30		49.3	81				
	150-360B	294	33	1450	32.8	80.5	3.0		
		367	29.5		36	82			
		440	25		37.5	80			
		150-360B	267	27.5	1450	25.4	78.8	3.0	
			334	25		28.5	80		
			400	21.3		29.8	78		
	233		22.8	19.2		75.7			
150-460A	292	20.5	1450	20.9	78	3.0			
	350	17.5		22	76				
	412	71		1450	99.4		80.2	3.5	
	515	66			112.8		82		
	618	60			126.2		80		
	150-460A	377		58	1450		75.2	79.3	4.0
		472		54.5			86.4	81	
		566		48			94.9	78	
		346		47.5			57	78.5	
		150-460A		432	53.5		1450	64	80
516			37	69.7	75				
317			38	42.6	77				
150-460A	396	35	1450	48.1	78.5	3.3			
	475	28.2		50.7	72				
	350	65		1450	78.3		79.5	3.9	
	440	60			88.6		81		
	527	53.5			97.6		78.7		
150-460B	323	54	1450	60.3	78.7	3.7			
	403	50		68.2	80.5				
	484	44.5		75.2	78				
	300	44.4		46.5	78				
	150-460B	375	40	1450	51	80	3.4		
		450	34.5		57.1	74			
		260	35.5		33.5	74.8			
		324	33		37.3	78			
	150-605A	390	28.4	1450	40.7	74	3.2		
		467	112		182.6	78			
583		105	206		81				
700		95.5	233.4		78				
150-605A		440	96		1450	151.1		76.3	4.0
		550	88.5			168		79	
		648	81			187.5		76.3	
150-605A		412	82		1450	120		76.6	3.8
		515	75			134.8		78	
		605	68			151.4		74	
		378	67.5			82.3		75.5	
	472	61.5	102.6	77					
	526	55.5	106.8	74					

Technical Parameter

Model	Flow Range m³/h	Head m	Speed r/min	Power Range kW	Eff. %	NPSH mm			
150-605B	430	98	1450	149.2	76.8	4.7			
	536	90		166.4	79				
	617	82		181.5	76				
	150-605B	392	85	1450	118.9	76.3	4.2		
		490	78		133.3	78			
		576	70		148.1	74.2			
		150-605B	357	75.5	1450	96.2	75.9	4.0	
			446	68.5		108.2	77		
			535	60		118.4	74		
	323		62.5	73.4		74.9			
150-605B	403	57.5	1450	83.1	76	3.6			
	484	50		91.6	72				
	556	34		1450	60		86	3.8	
	695	30			64.9		87.5		
	834	25			67.2		84.5		
	200-320A	518		29	1450		48.8	84	4.0
		648		25.5			52	86.5	
778		31.3	54	83.5					
481		25	40.7	80.5					
200-320A		601	21.3	1450	41	85	4.1		
		720	17.2		42.3	80			
		440	18.9		29	78			
		550	17		32.3	79			
		612	15.3		32.9	77.5			
		200-320B	510		32.3	1450		52.7	85.2
637	28		56.2	86.5					
765	23.4		58	84					
475	28.5		44	83.8					
594	24.5		46.1	86					
713	20		46.9	82.9					
200-320B	445		23.8	1450	35.6		81.3	3.4	
	558	21	38		84				
	670	17.2	38.4		81.8				
	412	20	28.8		78				
	200-320B	515	17	1450	29.1	82	3.8		
		595	14.2		29.5	78			
		567	57		1450	104		84.5	3.9
		709	52			116		86.5	
850	47	129	84.5						
200-420A	504	47.5	1450	79.1	82.5	3.8			
	530	42.5		86.3	84.5				
	756	37.5		93.1	83				
	458	40		62	80.5				
	200-420A	572	35.5	1450	66.7	83	3.9		
		684	30		68.8	81.6			
		409	32.5		45.8	79			
		511	27.5		49	81			
		613	24		50.1	80			

Model	Flow Range m³/h	Head m	Speed r/min	Power Range kW	Eff. %	NPSH mm
200-420B	518	54	1450	90.8	84	3.5
	648	48.5		99.1	85.5	
	778	42		107	83.5	
	467	45		69.8	82	
	583	40.5		76.6	84	
200-420B	700	35	1450	81.9	81.5	3.5
	423	38		54.8	80	
	530	34.5		60.6	82	
	635	29		63.1	79.5	
	375	31.5		41.5	77.5	
	468	28		45.8	78	
	562	24		47.5	77.3	
200-520A	654	97	1450	210	82.2	4.0
	817	91		241	84	
	980	83		272	81.5	
	605	82.5		170	80.2	
	756	76.5		192	83	
200-520A	907	70	1450	215	80.4	4.5
	565	67		132	78.1	
	706	62.5		148	81	
	847	55		163	78	
	518	52.3		98	75.5	
	648	47.5		107	78.5	
	778	42		117	76.2	
200-520B	588	88	1450	175	80.3	3.5
	734	81.7		197	83	
	880	73.2		219	80.3	
	556	74		141	79.6	
	695	68		159	81	
200-520B	834	60	1450	172	79.8	3.8
	524	60		109	78.5	
	655	55		123	80	
	783	48.5		134	78	
	478	48		81	76.8	
	598	43.5		91	78	
	717	38		98	76	
200-670A	634	157.5	1450	350	77.7	3.6
	792	150		404	80	
	936	140		457	78.2	
	596	134.5		285	76.7	
	745	127		328	78.5	
	894	114.5		367	76	
	562	114.5		231	76	
	702	107		266	77	
	842	95.5		293	74.8	
	527	95.5		183	74.8	
200-670A	659	88	1450	208	76	3.0
	770	80		227	74	

Technical Parameter

Model	Flow Range m³/h	Head m	Speed r/min	Power Range kW	Eff. %	NPSH mm	
200-670B	576	142	1450	289	77.2	3.4	
	720	132.5		329	79		
	864	120		372	76		
	200-670B	530	123	1450	231	76.8	3.3
		662	114.5		263	78.5	
		795	104		296	76	
		493	106		187	76.1	
		616	98.5		212	78	
	200-670B	720	90	1450	232	76	3.2
		455	90		149	74.8	
569		83	167		77		
683		73	184		74		
250-370A		840	44		1450	118	
	1051	39	127	88			
	1260	33.5	137	84			
	250-370A	795	37.5	1450	99	82.3	5.0
		994	33		107	86	
		1192	27.7		109	82.3	
		755	31.5		83	78	
		946	27		83.6	83	
	250-370A	1131	21	1450	83.6	77.5	5.0
		756	23		62.3	76	
871		20	61.2		77.5		
1008		16	57.8		76		
250-370B		823	42.3		1450	112	
	1029	37	119	87			
	1235	31	124	84.3			
	250-370B	775	37	1450	94.9	82.3	4.7
		968	32		98.1	86	
		1162	27		103.6	82.5	
		732	32		79.7	80	
		914	27		80	84	
	250-370B	1097	22	1450	82.2	80	4.7
		680	25.6		61.6	77	
850		22	62.1		82		
1020		17	61.3		77		
250-480A		938	73.5		1450	222	
	1173	66	239	88			
	1408	58	262	85			
	250-480A	864	60.5	1450	166	82.8	3.95
		1080	55		188	86	
		1296	47.5		202	83	
		800	50		136	80	
		1000	45.5		149	83	
	250-480A	1200	38	1450	160	77.6	3.95
		743	42		110	77	
929		37.5	119		80		
1115		32	126		77		

Model	Flow Range m³/h	Head m	Speed r/min	Power Range kW	Eff. %	NPSH mm	
250-480B	864	62	1450	177	82.5	4.1	
	1044	55.5		191	84		
	1296	45		199	80		
	250-480B	780	53.5	1450	141	81	4.1
		976	47		149	84	
		1171	42		163	82	
		708	45		111	78.6	
		886	40.5		121	80.5	
	250-480B	1063	34	1450	126	78	3.6
		642	40		94.6	74	
803		34.5	96.1		78.5		
963		28.5	98.4		76		
250-600A		994	126		1450	411	
	1242	116	467	84			
	1490	105	520	82			
	250-600A	933	108	1450	333	82.5	4.5
		1166	100		380	83.5	
		1400	90		421	81.5	
		867	90		262	81.3	
		1084	83		295	83	
	250-600A	1300	73.5	1450	322	81	4.3
		800	74		204	80.3	
1000		66	218		82.5		
1200		60	244		80.5		
250-600B		835	114		1450	320	
	1044	104	356	83			
	1253	91.5	381	82			
	250-600B	772	98	1450	255	80.8	3.6
		965	90		287	82.5	
		1158	80		311	81.3	
		700	80.3		192	80	
		875	74.5		218	81.5	
	250-600B	1050	66	1450	235	80.3	3.3
		640	67.5		149	79	
800		62	168		80.5		
960		56.5	186		79.5		
250-700A		904	184		1450	579	
	1130	175	674	80			
	1356	164	775	78.2			
	250-700A	782	161	1450	444	77.2	3.3
		978	152		513	79	
		1174	141		578	78	
		738	136		358	76.5	
		922	128		415	77.5	
	250-700A	1106	111	1450	465	76.5	3.2
		692	113		280	76.1	
865		106	325		76.5		
1038		99	360		75.5		

Technical Parameter

Model	Flow Range m³/h	Head m	Speed r/min	Power Range kW	Eff. %	NPSH mm	
300-300A	878	28.8	1450	83.8	82.3	5.3	
	1098	24.5		85.2	86.5		
	1318	20		89.4	80.3		
	300-300A	835	23.5	1450	66.4	80.5	5.5
		1044	19.8		66.6	84.5	
		1253	15		63.2	81	
		806	19		52.8	79	
		1008	15.5		51.9	82	
	300-300A	1210	11.4	1450	48.2	78	5.7
		772	15		41.5	76	
865		11.5	37.8		80		
1158		75	32		74		
300-300B		745	26.2		1450	64.4	
	936	23	69	85			
	1123	20	72.9	84			
	300-300B	691	24	1450	56.2	80.5	4.0
		864	20		56	84	
		1037	15.8		55.1	81	
		639	20		45.5	76.5	
		800	16.7		44.9	81	
	300-300B	960	13.5	1450	44.6	79	4.2
		560	17.5		37.1	72	
700		15	37.1		77		
840		12	36.1		76		
300-435A		1342	60		1450	257	
	1677	53	275	89			
	2012	46	295	85.5			
	300-435A	1262	52	1450	213	84	7.2
		1577	45		223	86.5	
		1892	37.5		230	84	
		1181	42.5		171	80	
		1476	36.5		175	84	
	300-435A	1771	28.5	1450	172	80	7.4
		1088	33.8		132	76	
1360		27.5	129		79		
1530		24	128		78		
300-435B		1396	57.5		1450	240	
	1620	51.5	260	88			
	1944	43.5	273	84.5			
	300-435B	1215	51.5	1450	206	83	6.9
		1519	45		215	86.5	
		1823	37.5		222	84	
		1138	43.5		168	80.5	
		1422	37.5		173	84	
	300-435B	1706	30	1450	174	80	6.9
		1066	35		130	78	
1332		30.5	136		81.5		
1598		24.8	138		77.5		

Model	Flow Range m³/h	Head m	Speed r/min	Power Range kW	Eff. %	NPSH mm	
300-560A	1397	101.5	1450	454	85.2	5.7	
	1746	94		520	87		
	2095	83.5		570	83.5		
	300-560A	1316	83.5	1450	357	83.8	6.4
		1645	76		398	85.5	
		1974	67		433	83.3	
		1258	68		281	83	
		1573	62		313	85	
	300-560A	1888	54	1450	339	82	6.7
		1213	57		232	81.2	
1516		50	247		83.5		
1819		42	260		80		
300-560B		1238	88.5		1450	359	
	1548	80	399	85			
	1858	70	427	83			
	300-560B	1158	75	1450	286	82.7	5.55
		1447	67		316	83.5	
		1736	57		331	81.5	
		1089	64		235	81	
		1361	57		255	83	
	300-560B	1633	50	1450	273	81.5	6.15
		1026	53		186	79.5	
1282		47.5	204		82		
1538		41	213		80.8		
300-700A		1469	170		1450	810	
	1836	160	941	86			
	2070	151	1012	84.2			
	300-700A	1388	147	1450	662	84	4.95
		1735	136		760	84.6	
		2082	125		854	83	
		1298	122		521	82.8	
		1623	112		567	84.3	
	300-700A	1948	100	1450	648	82	5.0
		1230	100		408	82.2	
1537		91	454		84		
1845		80	500		80.5		
300-700B		1350	152		1450	679	
	1688	139	765	83.5			
	2026	124	840	81.5			
	300-700B	1258	130	1450	544	82	4.85
		1573	119		614	83	
		1888	105		667	81	
		1160	108		422	81	
		1450	99		474	82.5	
	300-700B	1740	87	1450	512	80.5	4.35
		1074	90		328	80.3	
1342		81	361		82		
1610		71.5	391		80.3		

Technical Parameter

Model	Flow Range	Head	Speed	Power Range	Eff.	NPSH		
	m³/h	m	r/min	kW	%	mm		
350-360A	1385	37.5	1450	171	83	8.05		
	1731	32		175	86.5			
	2077	25		175	81			
	1354	32	1450	146	81	8.4		
	1692	26.5		144	85			
	2030	20		138	80			
	350-360B	1313	26.5	1450	120	78.8	8.7	
		1641	21		113	83		
		1969	15		103	78		
		350-430A	1282	20	1450	91	76.3	8.9
1602			15	81		80.5		
1922			9	64		74		
350-430B			1138	35.5	1450	133	83	6.2
			1422	31		140	85.5	
			1706	25.8		144	83.3	
			350-510A	1068	30.5	1450	110	81
	1335			26.3	114		84	
	1602			21.3	115		81	
	350-510B			1016	25.6	1450	90	79
		1270		22.5	95		82	
		1524		17.5	93		78	
		350-590A		950	21.5	1450	74	75.5
1188				17.8	74		78	
1397				13.7	71		74	
350-590B				2194	49.5	1450	353	84
			2743	43.5	371		87.5	
			3292	35	371		84.7	
			350-590C	2108	41.5	1450	291	82
	2635			35	294		85.5	
	3162			27	281		82.8	
	350-590D			2050	33	1450	231	80
		2563		27.5	229		84	
		3076		20	210		80	
		350-590E		1987	27	1450	187	78
2484				21.5	180		81	
2981				15	160		76.3	
350-590F				1786	48	1450	277	84.2
			2232	42.5	299		86.5	
			1678	35	303		84.2	
			350-590G	1670	42.5	1450	237	81.5
	2088			36	242		84.5	
	2506			38.8	240		82	
	350-590H			1590	35	1450	193	78.5
		1987		30	198		82	
		2384		23.5	195		78.2	
		350-590I		1486	30	1450	160	76
1858				25	161		78.5	
2230				18.5	148		76	

YSC Structure

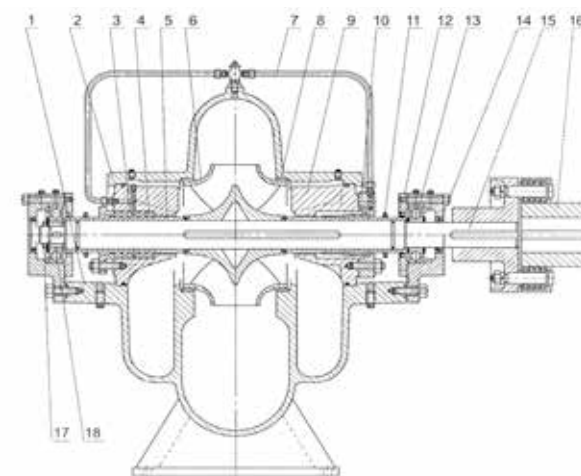

No.	Part	No.	Part
1	Pump Body	12	Bearing House
2	Impeller	13	Shaft
3	Pump Cover	14	Skeleton Oil Seal
4	Flushing Pipe	15	Circlip
5	Seal Ring	16	Bearing Block Ring
6	Vent Plug	17	Bearing
7	O-Ring	18	Shaft Sleeve
8	Seal House	19	Mechanical Seal or Stuffing Seal
9	Seal Gland or Packing Gland	20	Bearing Sleeve
10	Block Water Rin	21	Nut
11	Bearing Cover		

YSCL Structure

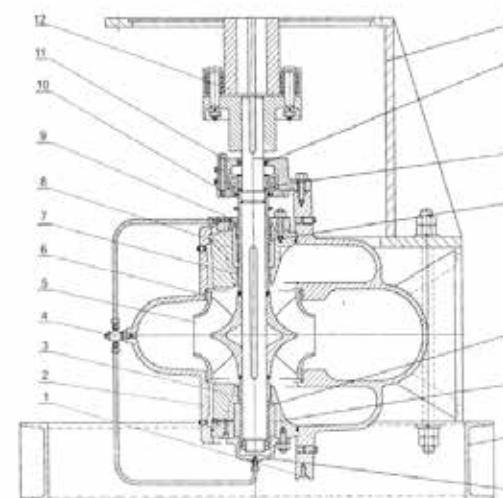

No.	Part	No.	Part
1	Pump Body	14	Bearing Washer
2	Pump Cover	15	Bearing Block Ring
3	Shaft Sleeve	16	Circlip
4	Shaft	17	Skeleton Oil Seal
5	Impeller	18	Bearing
6	Seal Ring	19	Motor Base
7	Shaft Sleeve	20	Mechanical Seal or Stuffing Seal
8	Vent Plug	21	Shaft Sleeve
9	Seal House	22	Water Pilot Bearing
10	Flushing Pipe	23	O-Ring
11	Seal Gland or Packing Gland	24	Water Pilot Bearing Cover
12	Bearing Cover	25	Base
13	Bearing House		

Flange Size

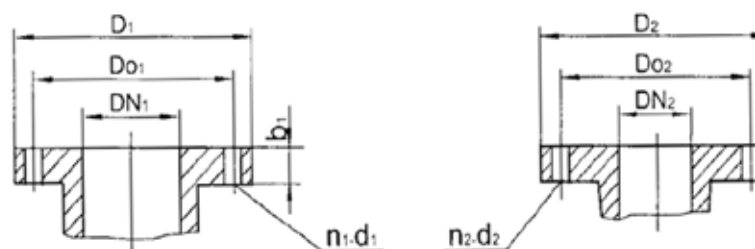

Model	Inlet Flange							Discharge Flange								
	D1	D1	DN1	b1	n1-d1	DO1	n1-d1	D2	D2	DN2	b2	n2-d2	DO2	n2-d2		
80-210																
80-270	270	210	125	30	8-φ18	220	8-φ26	195	160	80	26	8-φ18	160	8-φ18		
80-370																
100-250	300	240	150	34	8-φ23	250	8-φ25	230	180	100	28	8-φ18	190	8-φ23		
100-310								254								
100-375	318															
125-230	365	295	200	34	12-φ23	310	12-φ26	275	210	125	35	8-φ18	220	8-φ26		
125-290							12-φ28							8-φ28		
125-365																
125-500																
150-290	360	295	200	34	12-φ23	310	12-φ26	300	240	150	34	8-φ23	250	8-φ26		
150-360																
150-460																
150-605															365	310
200-320	425	355	250	36	12-φ26	370	12-φ30	360	295	200	41	12-φ23	310	12-φ26		
200-420								365								
200-520								360								
200-670								365							310	12-φ26
250-370	485	410	300	40	12-φ23	430	16-φ30	425	350	250	36	12-φ23	370	12-φ30		
250-480					12-φ26										12-φ26	
250-600					16-φ30										16-φ30	
300-300					550										460	350
300-435	610	515	400	50	16-φ26	550	16-φ36									
300-560	525				16-φ30			410								
300-700	550				16-φ36			430								
350-360	580	515	400	53	16-φ26	525	16-φ30	525	460	350	45	16-φ23	470	16-φ26		
350-430	645	565	450	50	20-φ26	585	20-φ30									
350-510	597	515	400	38	16-φ26	525	16-φ30								533	36

Other flange designs are available on request.

YSC Outlet Flange 80-350 Dimensions

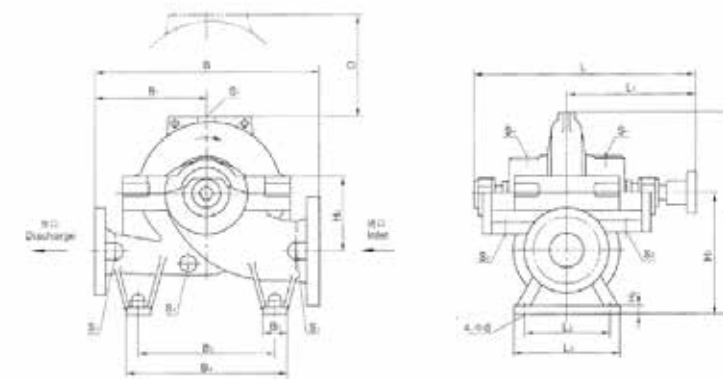

Model	L	L1	L2	L3	B	B1	B2	B3	B4	H	H1	H2	H3	O	S1	S2	4-φd
80-210	716	416	270	320	600	300	70	340	410	485	315	22	140	340	RC1/2"	C1/2"	4-17.5
80-270	716	416	270	320	600	300	70	340	410	485	315	22	140	380	RC1/2"	C1/2"	4-17.5
80-370	716	416	270	320	660	330	70	340	410	540	315	22	140	450	RC1/2"	C1/2"	4-17.5
100-250	716	416	270	320	660	330	70	400	470	550	355	22	170	390	RC1/2"	C1/2"	4-17.5
100-310	716	416	270	320	660	330	70	400	470	580	355	22	170	450	RC1/2"	C1/2"	4-17.5
100-375	715	415	270	320	740	370	70	400	470	715	355	20	170	520	RC1/2"	C3/4"	4-18
125-230	880	515	340	390	740	370	80	450	530	630	400	22	200	420	RC1/2"	C1/2"	4-18
125-290	880	515	340	390	740	370	80	450	530	630	400	22	200	460	RC1/2"	C1/2"	4-18
125-365	880	515	340	390	740	370	80	450	530	670	400	22	200	520	RC1/2"	C3/4"	4-23
125-500	880	515	340	390	900	450	80	560	630	705	400	22	200	610	RC1/2"	C3/4"	4-18.5
150-290	880	515	340	400	740	370	80	450	530	645	400	22	200	490	RC1/2"	C1/2"	4-18.5
150-360	880	515	340	390	800	400	80	450	530	675	400	22	200	530	RC1/2"	C3/4"	4-18.5
150-460	1011	590	430	480	900	450	70	560	630	700	400	20	200	610	RC1/2"	C3/4"	4-23
150-605	1011	590	430	480	1100	500	70	700	770	870	500	20	300	740	RC1/2"	C1/2"	4-17.5
200-320	1011	590	430	480	900	450	70	560	630	785	500	20	240	570	RC1/2"	C3/4"	4-23
200-420	1011	590	430	480	1000	500	70	560	630	810	500	20	240	620	RC1/2"	C3/4"	4-23
200-520	1129	655	430	480	1100	500	70	700	770	830	560	26	300	740	RC1/2"	C3/4"	4-23
200-670	1127	655	400	480	1200	550	100	700	800	1035	600	26	350	860	RC1/2"	C3/4"	4-23
250-370	1129	655	400	480	1000	500	100	700	800	930	600	26	300	640	RC1/2"	C3/4"	4-23
250-480	1245	729	520	600	1100	550	100	700	800	965	600	26	300	710	RC1/2"	C3/4"	4-22
250-600	1245	729	520	600	1200	550	100	700	800	1045	630	26	350	830	RC1/2"	C1/2"	4-22
300-300	1129	655	400	480	1050	500	100	700	800	990	630	26	300	720	RC1/2"	C3/4"	4-22
300-435	1244	729	520	600	1200	550	100	700	800	1035	670	26	350	730	RC1/2"	C3/4"	4-22
300-560	1403	808	520	600	1350	650	100	950	1050	1140	710	26	350	860	RC1/2"	C3/4"	4-22
300-700	1403	808	520	600	1400	650	100	950	1050	1250	750	26	400	960	RC1/2"	C3/4"	4-22
350-360	1244	729	520	600	1200	550	100	700	800	1085	670	26	350	820	RC1/2"	C3/4"	4-22
350-430	1403	808	520	600	1400	650	100	950	1050	1215	750	26	400	930	RC1/2"	C3/4"	4-22
350-510	1405	810	520	600	1350	650	100	950	1050	1215	750	26	400	840	RC1/2"	C3/4"	4-22

Note: The dimensions to be maintained around the casing cover for dismantling of the rotor.



YSCL Outlet Flange 80-350 Dimensions

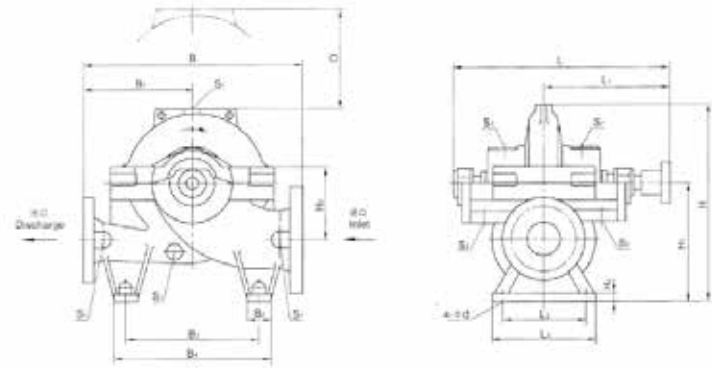

Model	A	A1	B	B1	B2	B3	B4	B5	b1	b2	H	h1	h2	h3	O
80-210	340	450	600	300	100	270	380	640	34.1	28.6	320	735	140	170	340
80-270	340	450	600	300	100	275	380	640	34.1	28.6	320	735	140	170	380
80-370	340	450	660	330	100	275	380	640	34.1	28.6	320	735	140	225	450
100-250	400	500	660	330	115	315	420	695	36.5	31.8	320	735	170	195	390
100-310	400	500	660	330	115	315	420	695	36.5	31.8	320	735	170	225	450
100-375	400	500	740	370	115	315	420	695	36.5	31.8	320	735	170	360	520
125-230	450	600	740	370	210	360	475	855	41.3	34.9	355	870	200	230	420
125-290	450	600	740	370	210	360	475	855	41.3	34.9	355	870	200	230	460
125-365	450	600	740	370	210	360	475	855	41.3	34.9	355	870	200	270	520
125-500	560	700	900	450	210	360	475	855	41.3	34.9	355	870	200	305	610
150-290	450	600	740	370	210	360	475	855	41.3	36.5	355	870	200	245	490
150-360	450	600	800	400	210	360	475	855	41.3	36.5	355	870	200	275	530
150-460	560	700	900	450	210	360	475	855	41.3	36.5	400	990	200	300	610
150-605	700	900	1100	500	315	460	575	1060	41.3	36.5	400	990	300	370	740
200-320	560	700	900	450	315	460	575	1060	47.6	41.3	400	990	240	285	570
200-420	560	700	1000	500	315	460	575	1060	47.6	41.3	400	990	240	310	620
200-520	700	900	1100	500	315	520	635	1120	47.6	41.3	440	1095	300	370	740
200-670	700	900	1200	550	315	560	685	1180	47.6	41.3	440	1095	350	435	860
250-370	700	900	1000	500	315	560	685	1180	50.8	47.6	440	1095	300	330	640
250-480	700	900	1100	550	315	560	685	1180	50.5	47.6	500	1230	300	365	710
250-600	700	900	1200	500	315	590	715	1210	51	48	500	1230	350	415	830
300-300	700	900	1050	500	315	590	715	1210	54	50.8	440	1095	300	360	720
300-435	700	900	1200	550	315	630	755	1250	57.5	50.8	500	1230	350	345	730
300-560	950	1200	1350	650	400	670	795	1375	57.5	50.8	570	1380	350	430	860
300-700	950	1200	1400	650	400	710	835	1415	57.5	50.8	570	1380	400	500	960
350-360	700	900	1200	550	315	630	755	1250	52.7	54	500	1230	350	415	820
350-430	950	1200	1400	650	400	710	835	1415	60.3	54	570	1380	400	465	930
350-510	950	1200	1350	650	400	710	835	1415	57.2	54	570	1380	400	465	840

Note: The dimensions to be maintained around the casing cover for dismantling of the rotor.

XA/XAT

Standardized End Suction Centrifugal Pump



Product Description

XA and XAT series standardized end suction centrifugal pumps are both designed according to EN733 / DIN24255 standard, with axial suction and radial discharge. XA series are long coupled structure, while XAT series are closed coupled structure. Various medium can be pumped by using different types of materials and mechanical seals. The back pull out design allows disassembling the casing cover and the rotary components without removing the casing and pipelines, which makes it much more convenient for the maintenance.

Application

They are used for clean water or medium with physical and chemical properties similar to water, and suitable for the usages from industrial applications to irrigation, from air conditioning and heating to washing systems such as: water treatment, textile industry, washing and cleaning, chemical industry, marine, paper-making, power plant, etc.

Medium

They are used for clean water or medium with physical and chemical properties similar to water. The medium contains solid insoluble matter, the particle size should be less than 3mm, the volume content should be less than 2%, and the viscosity should be less than 150cst. When the viscosity is from 20cst to 150cst, the performance should be corrected.

Operating Conditions

Medium temperature: -20°C ~ +85°C
 Maximum ambient temperature: +40°C
 Altitude: less than 1000m
 Relative humidity: less than 95%

Model Implication

XA (XAT) 200 / 40 A, B, C, D, E

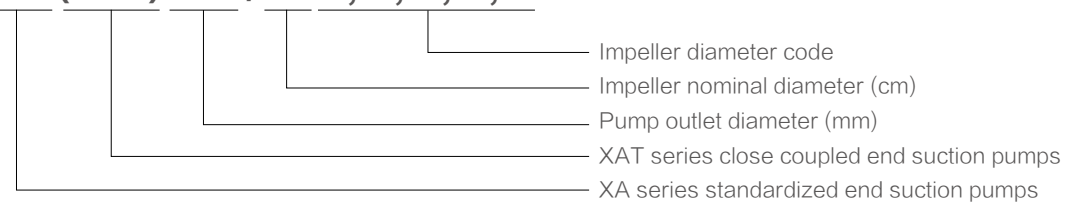

The parameters of XA series and XAT series (maximum power 90KW) are same. And they share the same casings and impellers.

Technology Applications

The pumps are mounted in horizontal, with axial suction and radial discharge and back pull out design. The stainless steel pumps adopt the precision casting, pickling oxidation treatment. They are constructed according to EN733 / DIN24255 standard.

Technical Parameters

Suc. Flange: DN50 ~ DN350mm
 Dis. Flange DN32 ~ DN300
 Qmax: 1440 m³/h
 Hmax: 150m
 Speed: 2900r/min, 1450r/min
 Working pressure: 1.6 ~ 2.5MPa
 Rotation direction: clockwise, viewed from driven end
 When the frequency is 60Hz, please refer to the selection chart.

Motor

IE3 is the standard motor, IE2, IE4 and IE5 motors are optional. Explosion-proof, variable frequency or other types of motors can be made by order too.

Scope of Performance

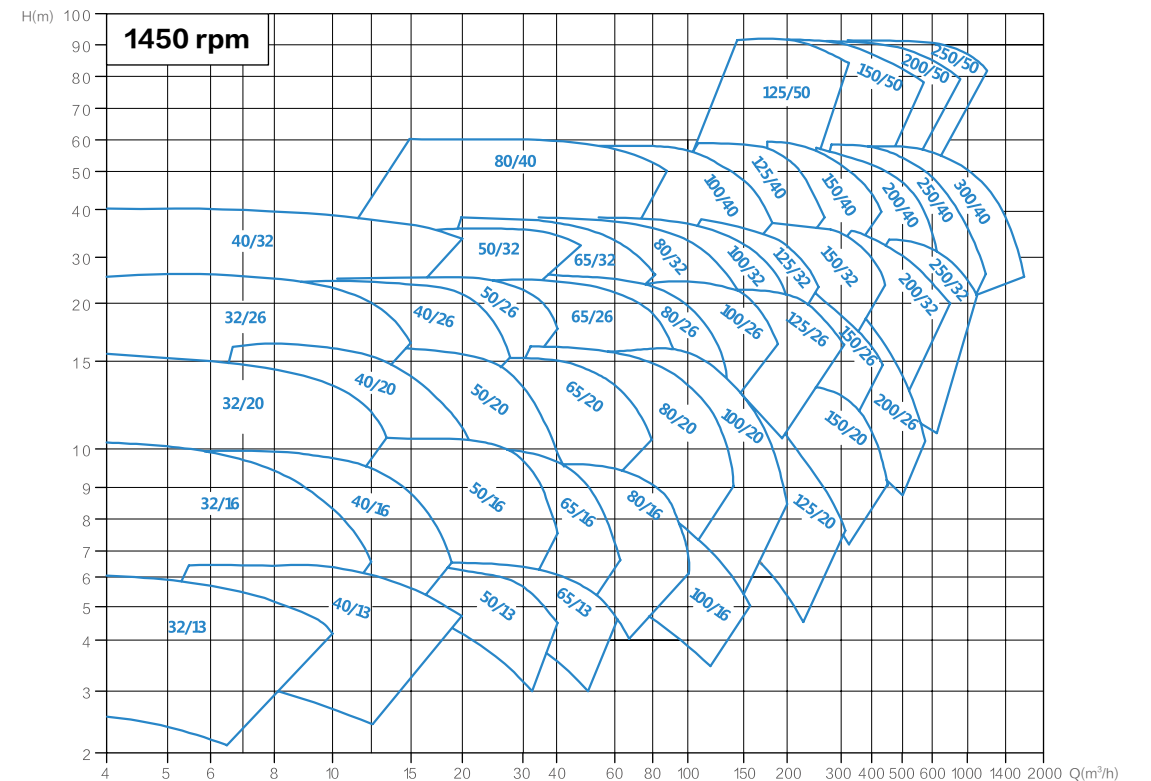
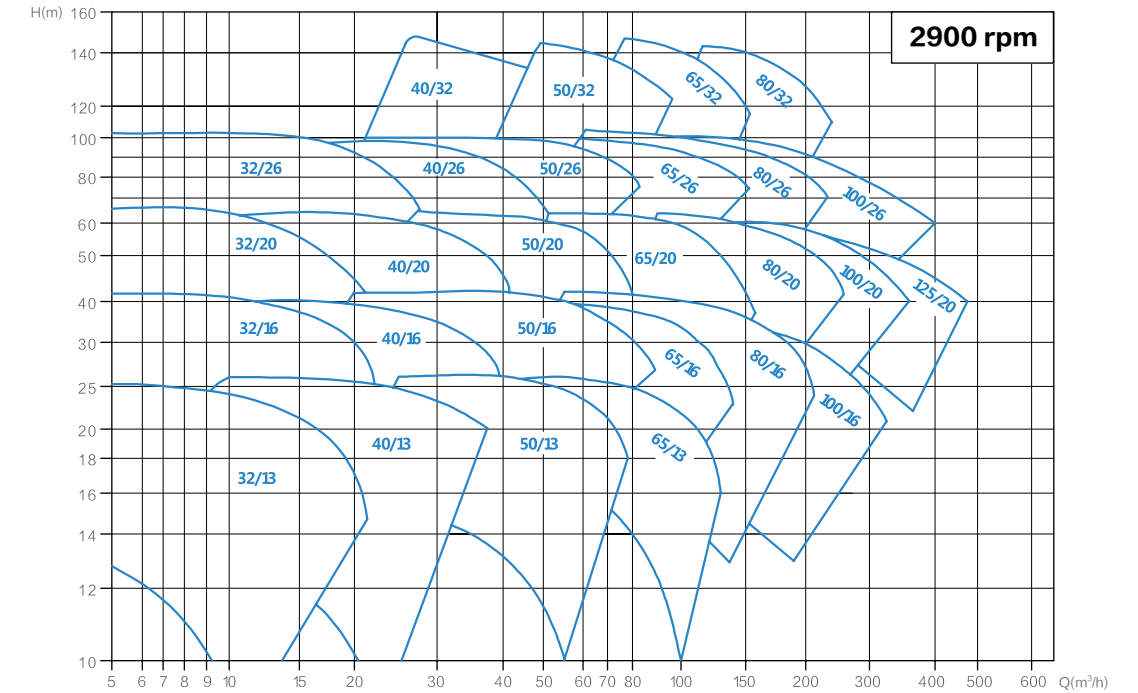

Scope of Performance

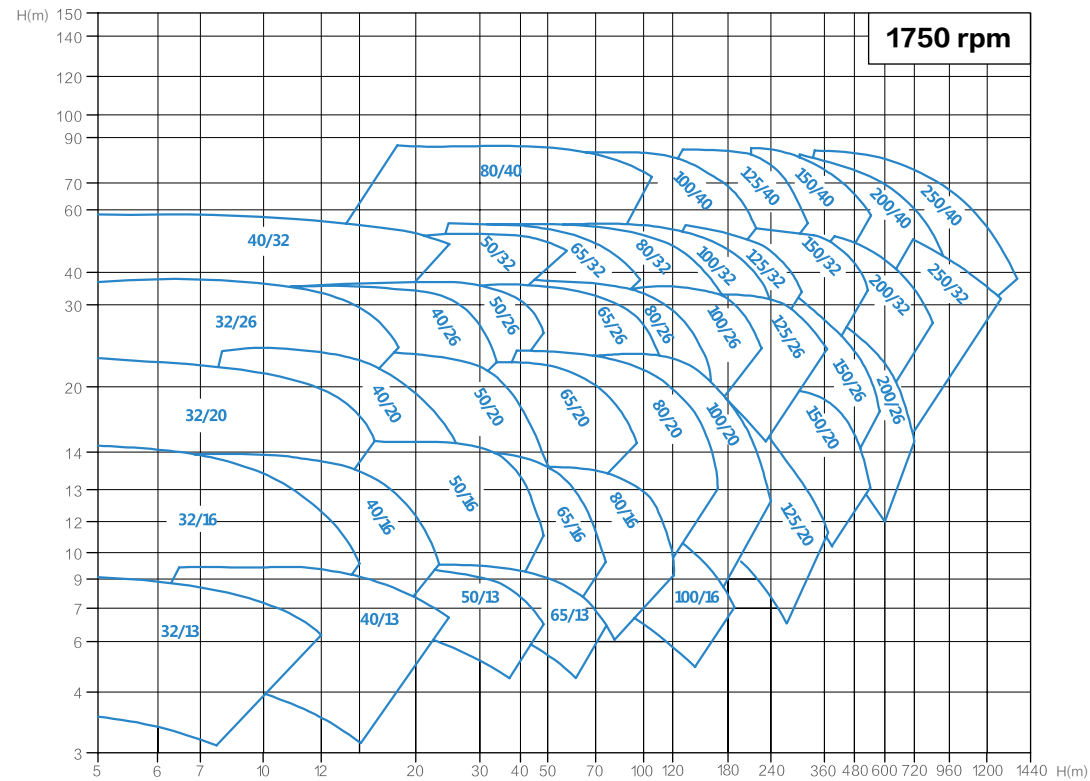
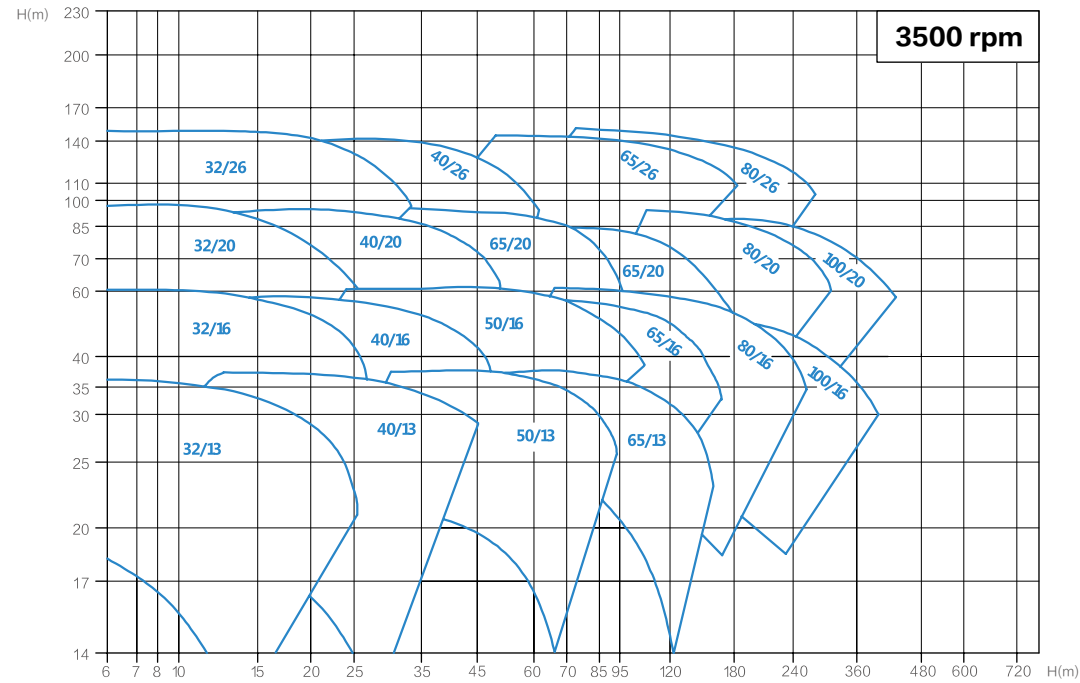

XA(T) 32/13-2900r/min Performance curve

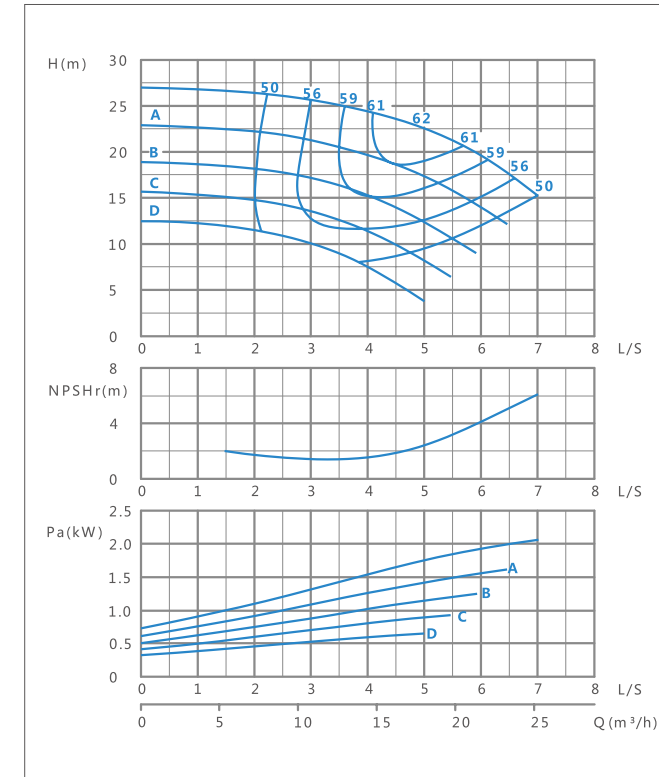

XA(T) 32/16-2900r/min Performance curve

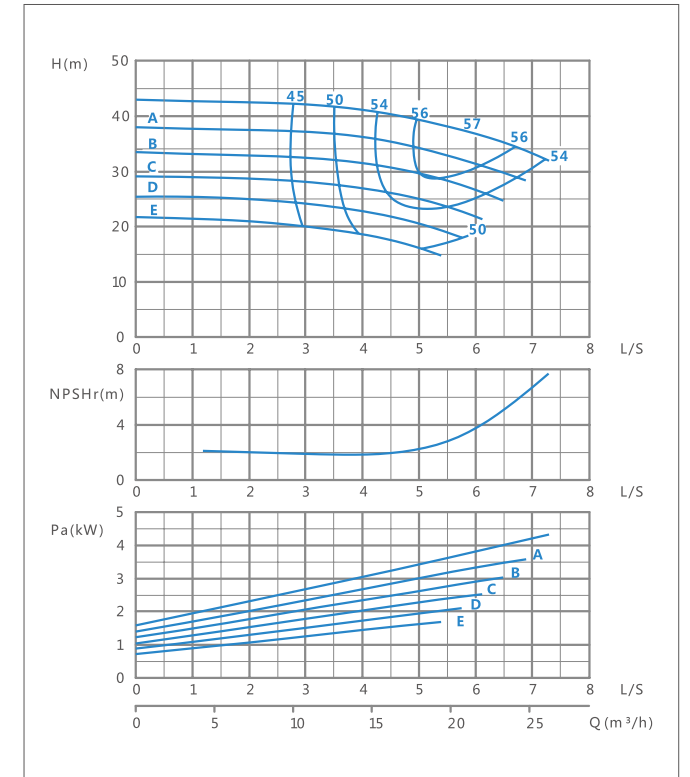

XA(T) 32/20-2900r/min Performance curve

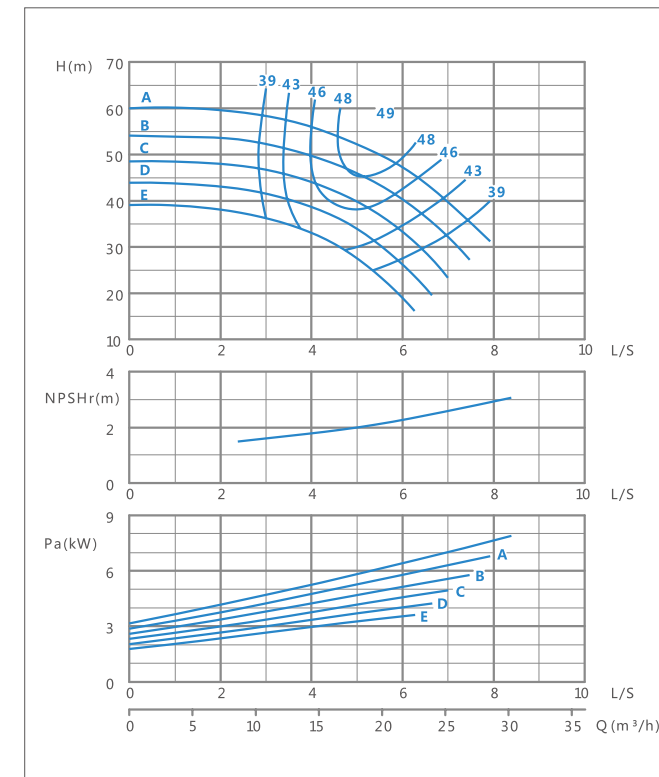

XA(T) 32/26-2900r/min Performance curve

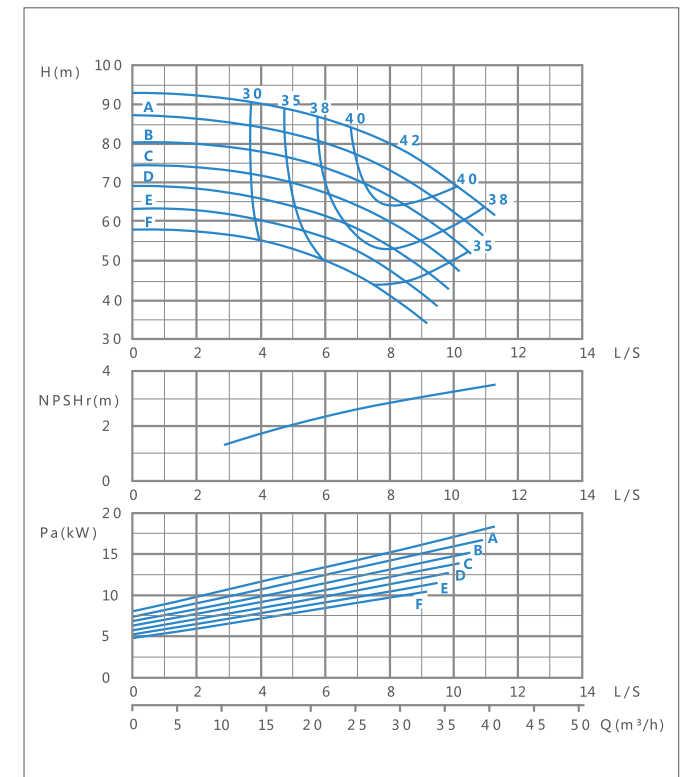

XA(T) 40/13-2900r/min Performance curve

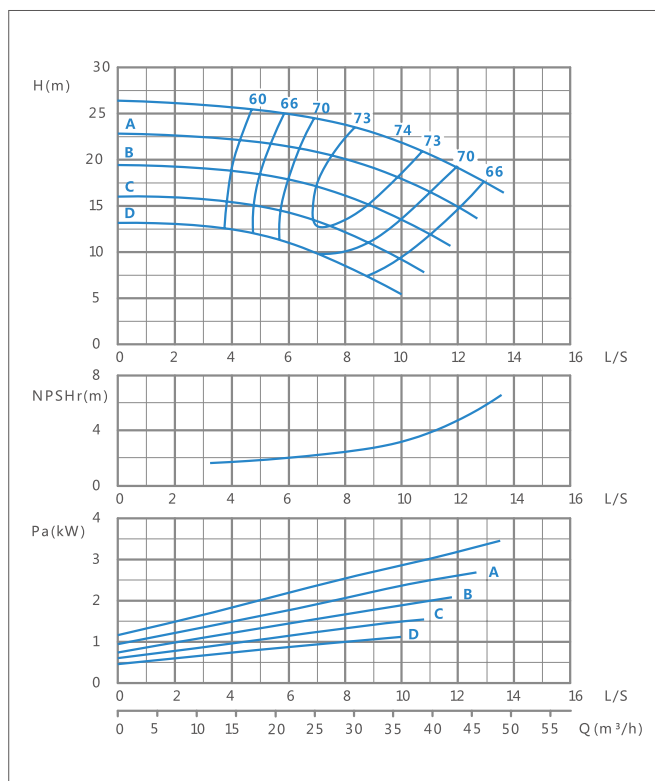

XA(T) 40/16-2900r/min Performance curve

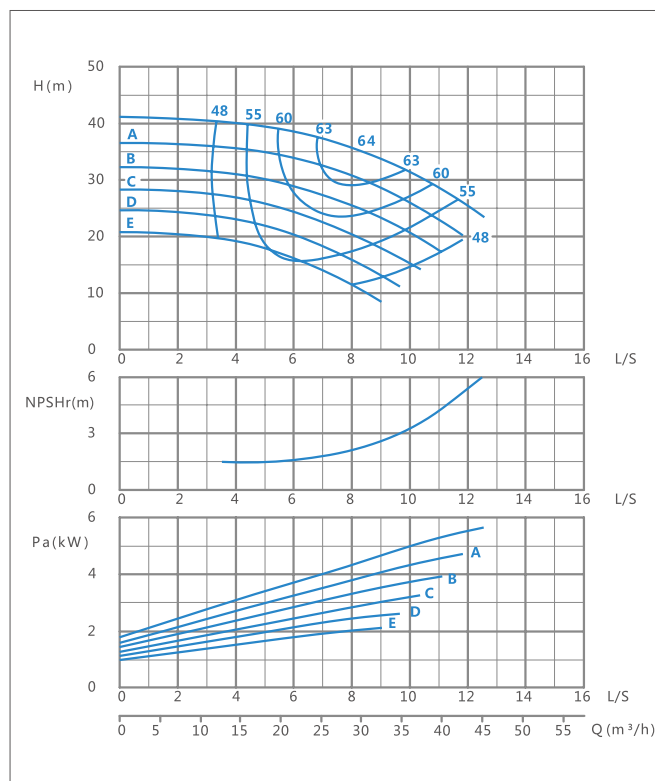

XA(T) 40/32-2900r/min Performance curve

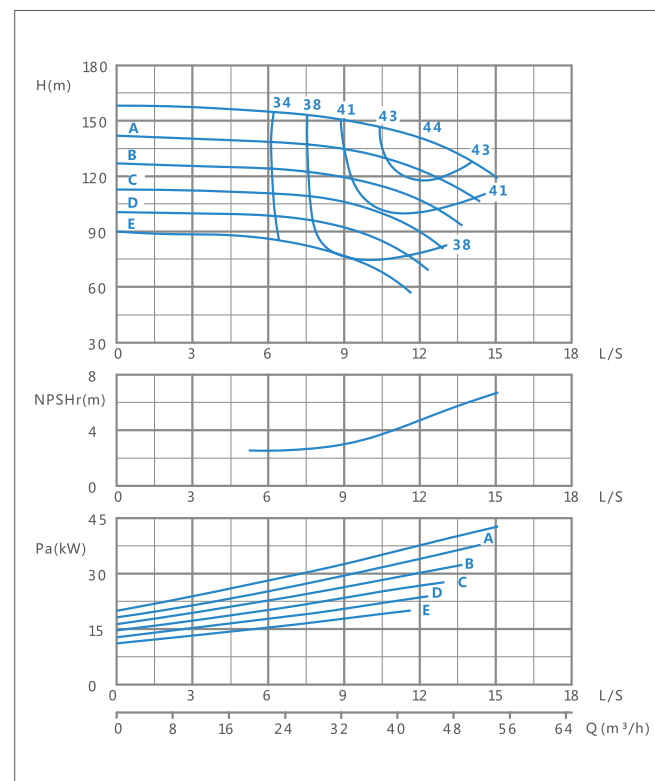

XA(T) 50/13-2900r/min Performance curve

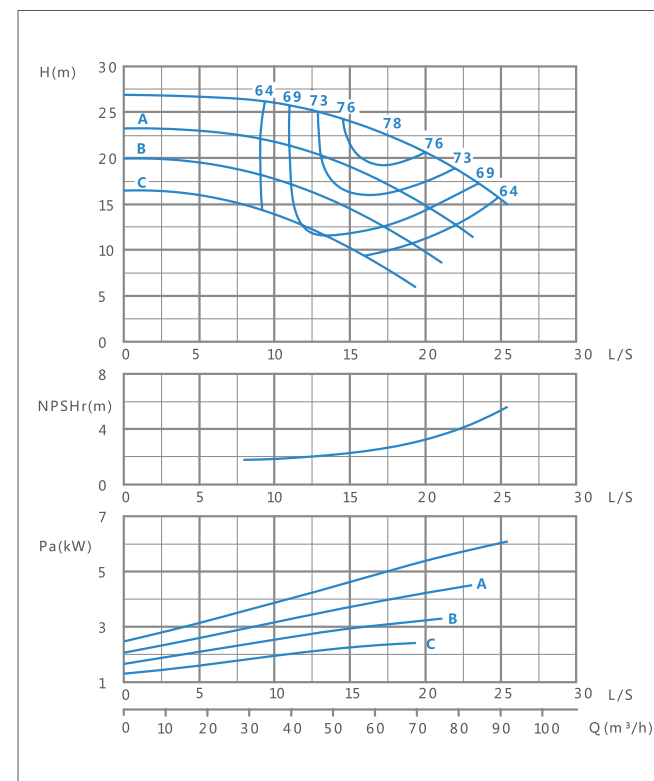

XA(T) 40/20-2900r/min Performance curve

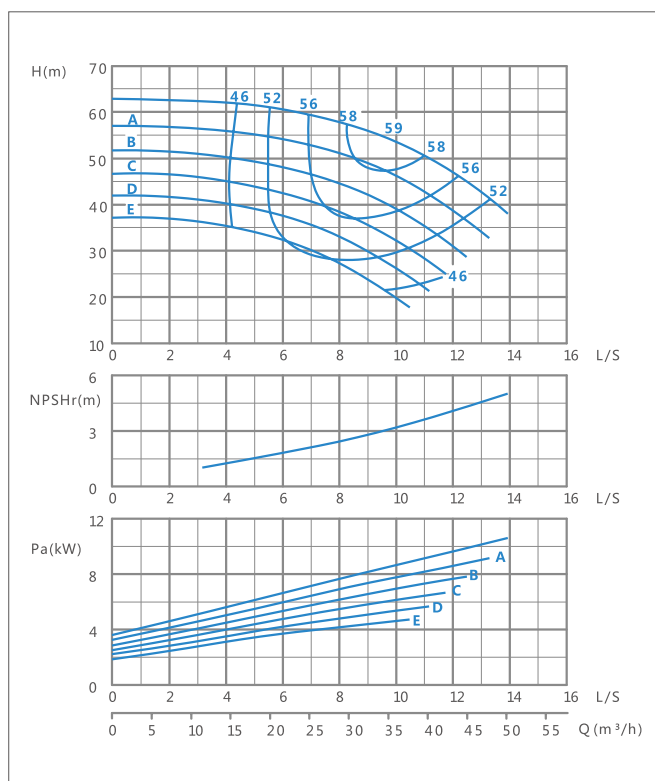

XA(T) 40/26-2900r/min Performance curve

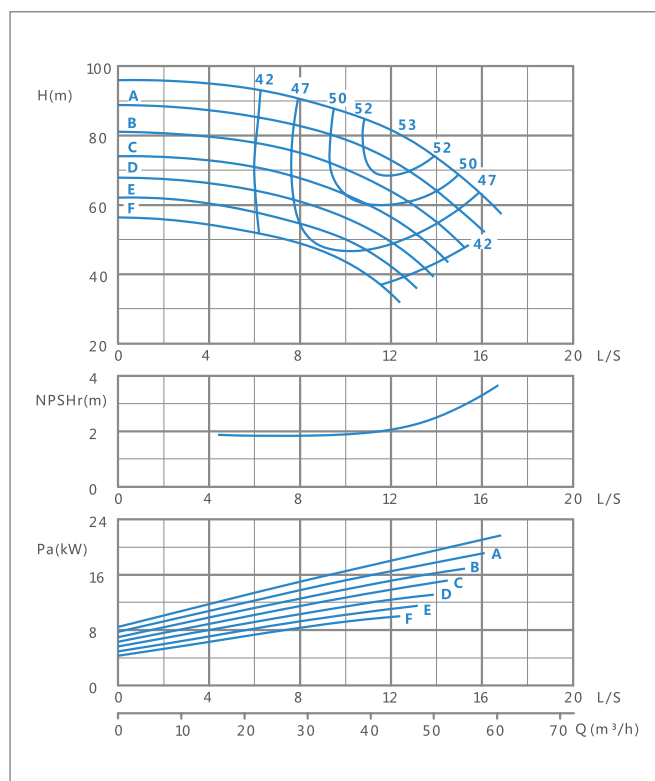

XA(T) 50/16-2900r/min Performance curve

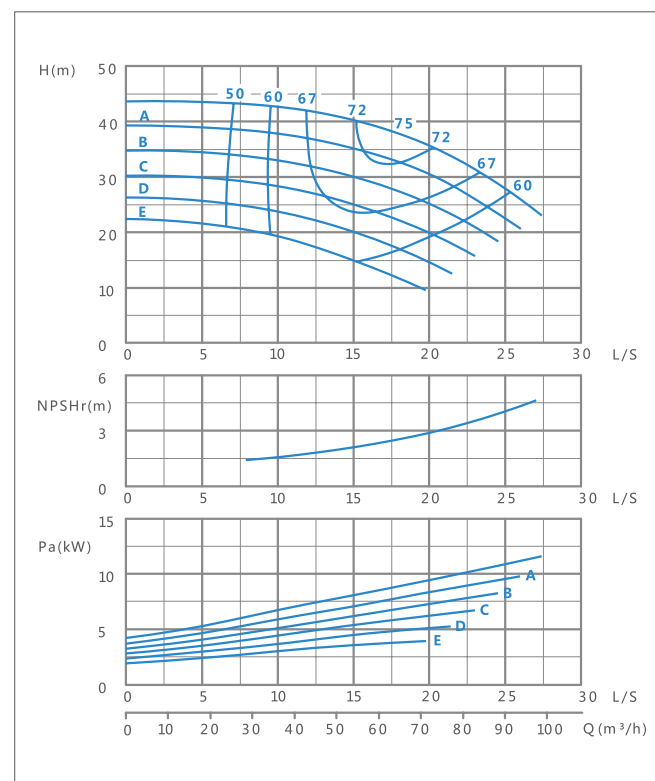

XA(T) 50/20-2900r/min Performance curve

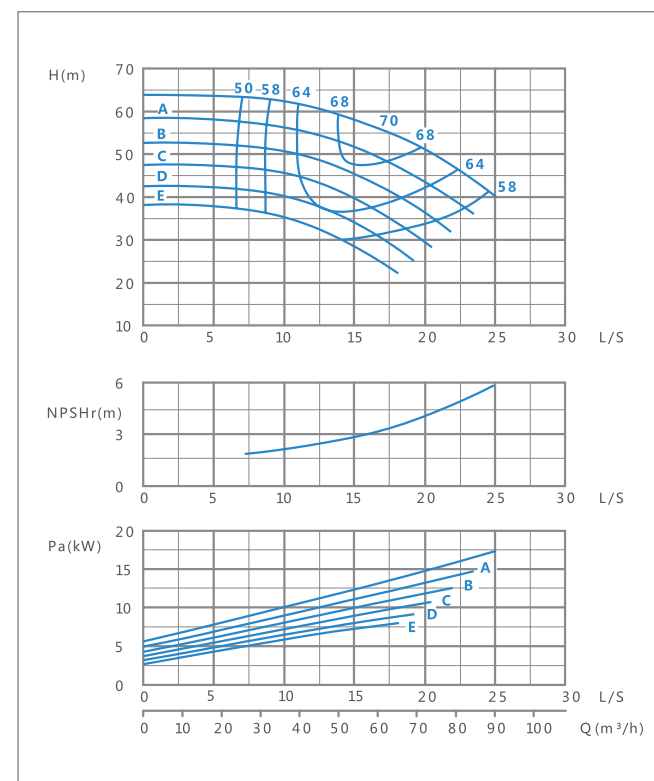

XA(T) 50/26-2900r/min Performance curve

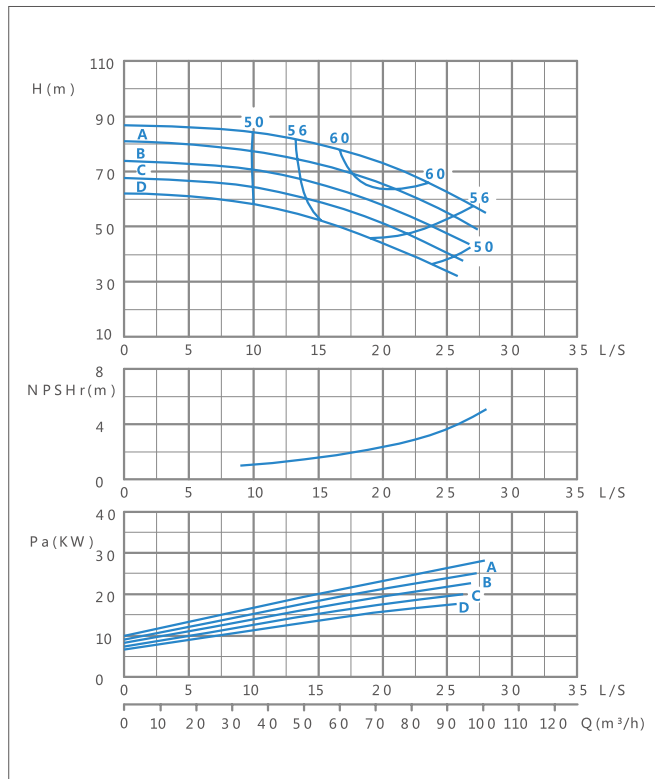

XA(T) 50/32-2900r/min Performance curve

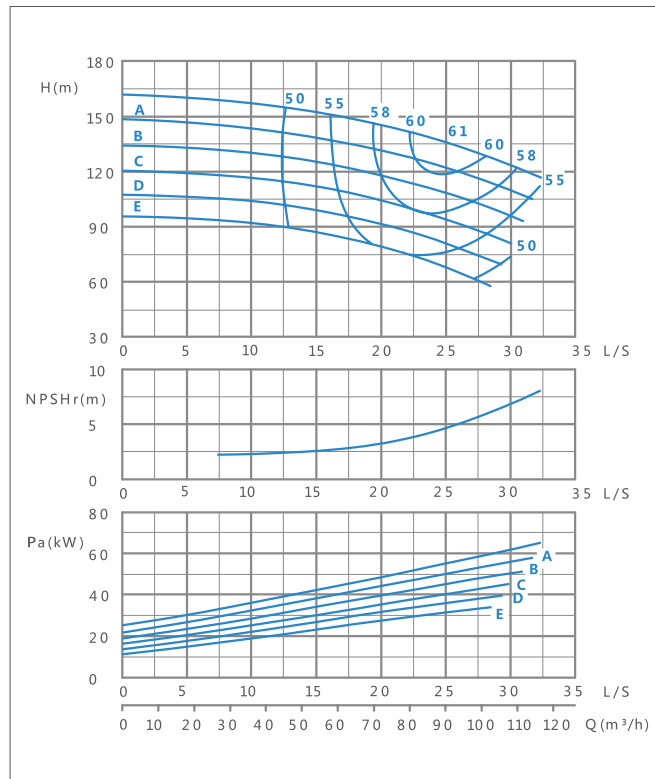

XA(T) 65/20-2900r/min Performance curve

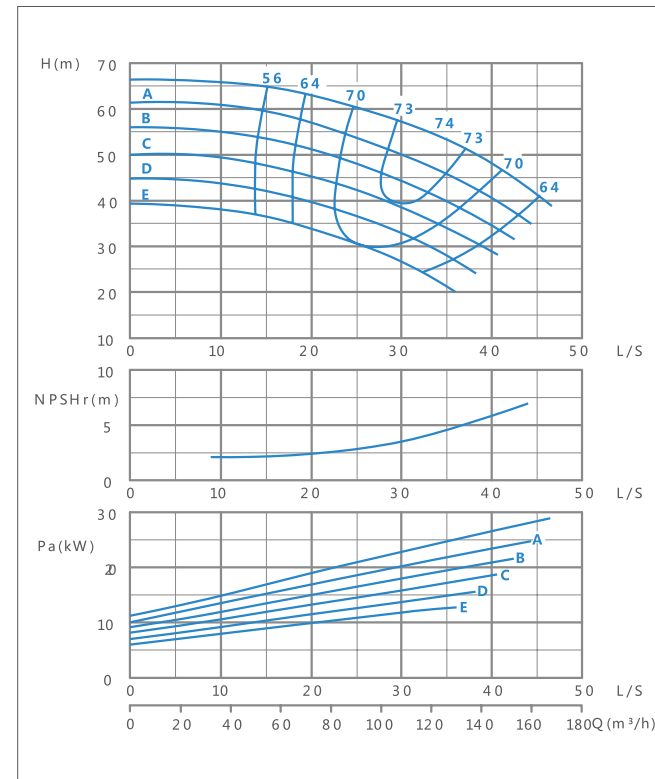

XA(T) 65/26-2900r/min Performance curve

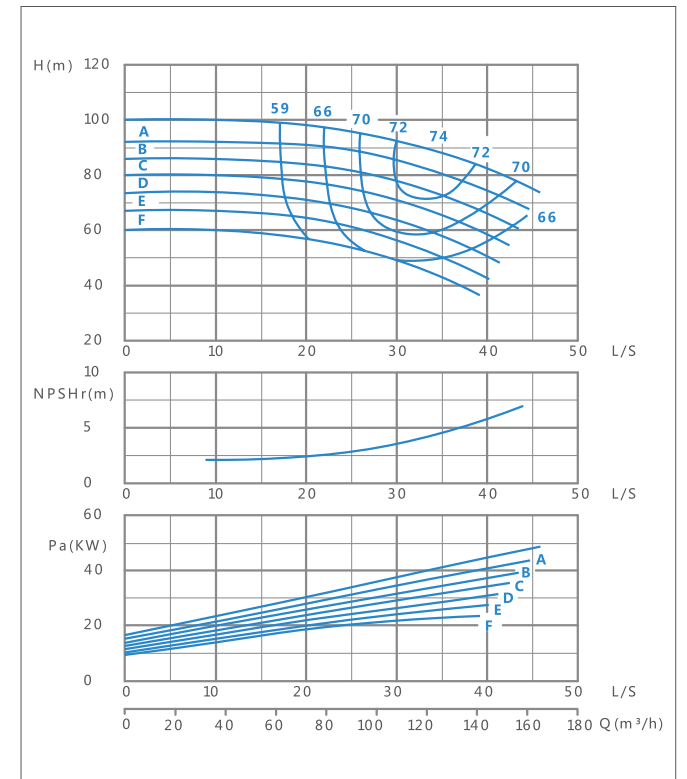

XA(T) 65/13-2900r/min Performance curve

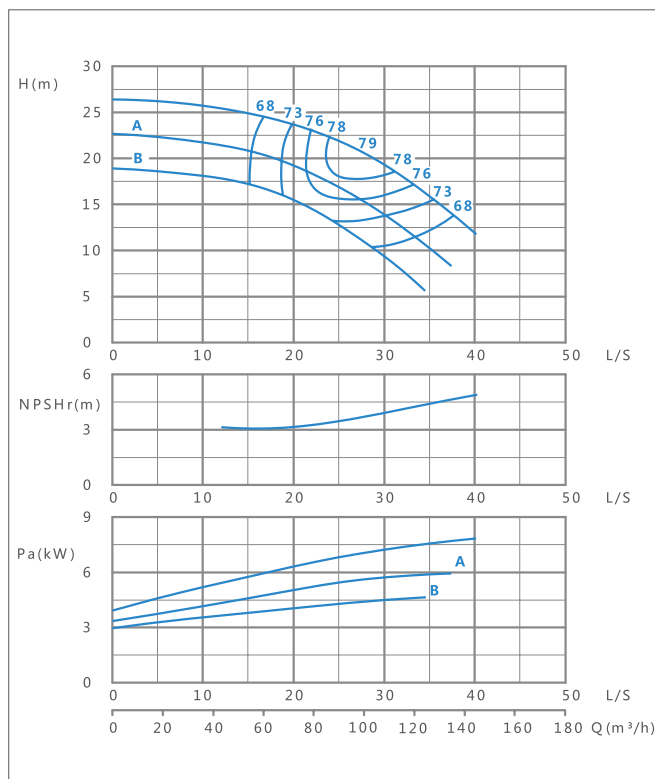

XA(T) 65/16-2900r/min Performance curve

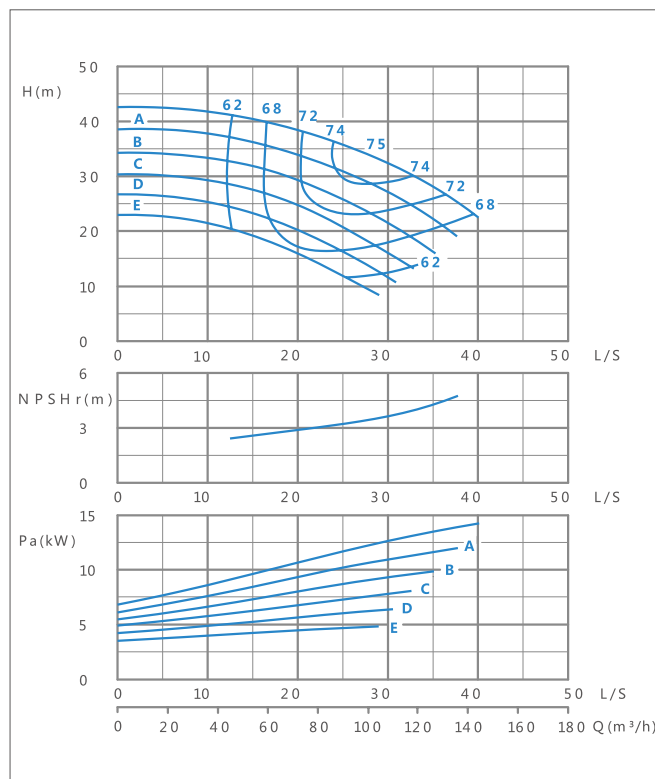

XA(T) 65/32-2900r/min Performance curve

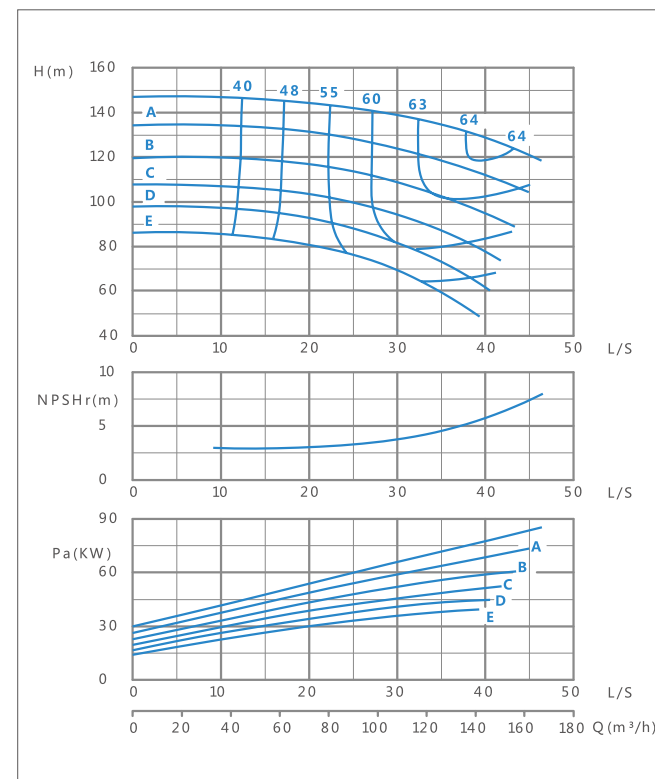

XA(T) 80/16-2900r/min Performance curve

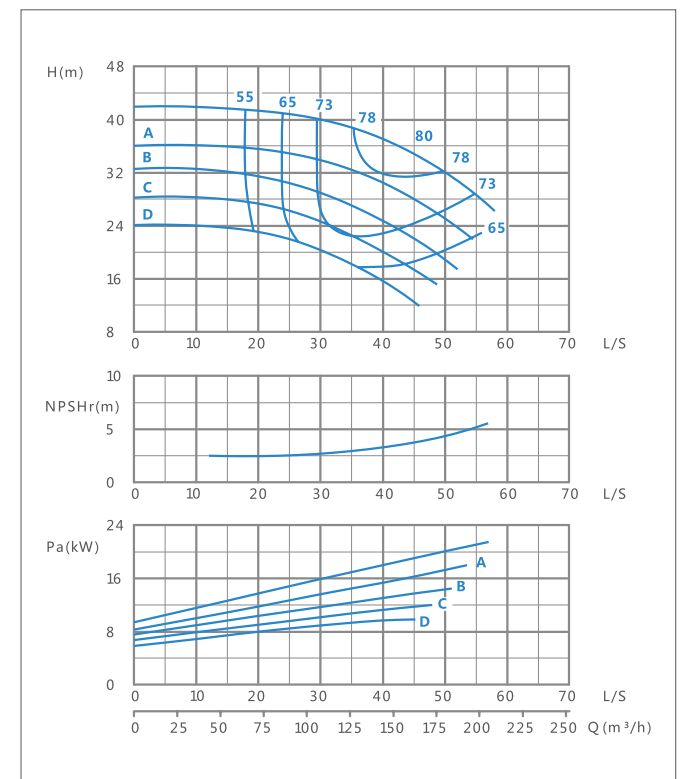

XA(T) 80/20-2900r/min Performance curve

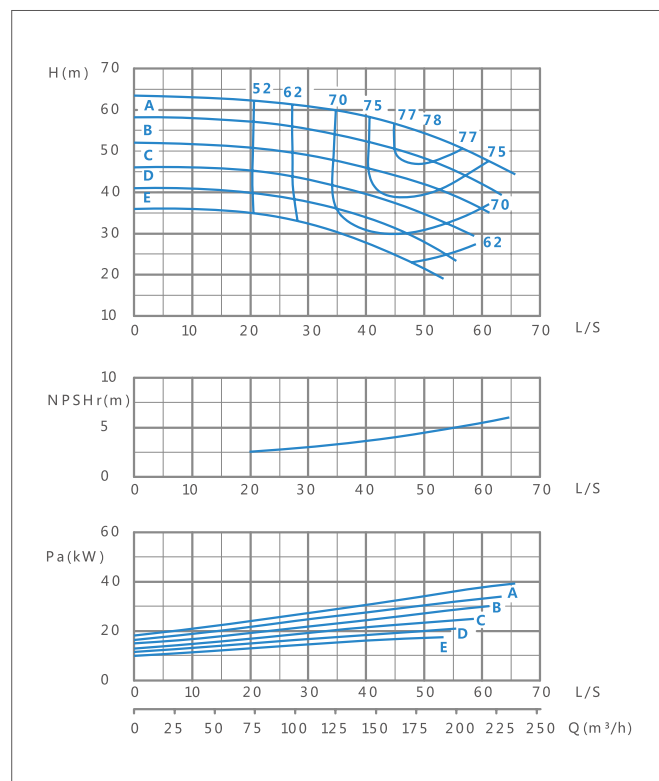

XA(T) 80/26-2900r/min Performance curve

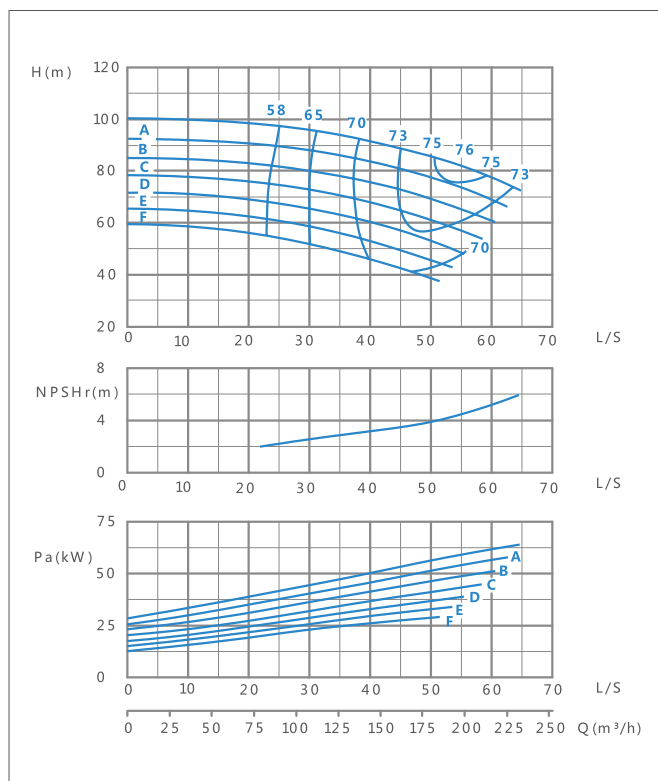

XA(T) 100/20-2900r/min Performance curve

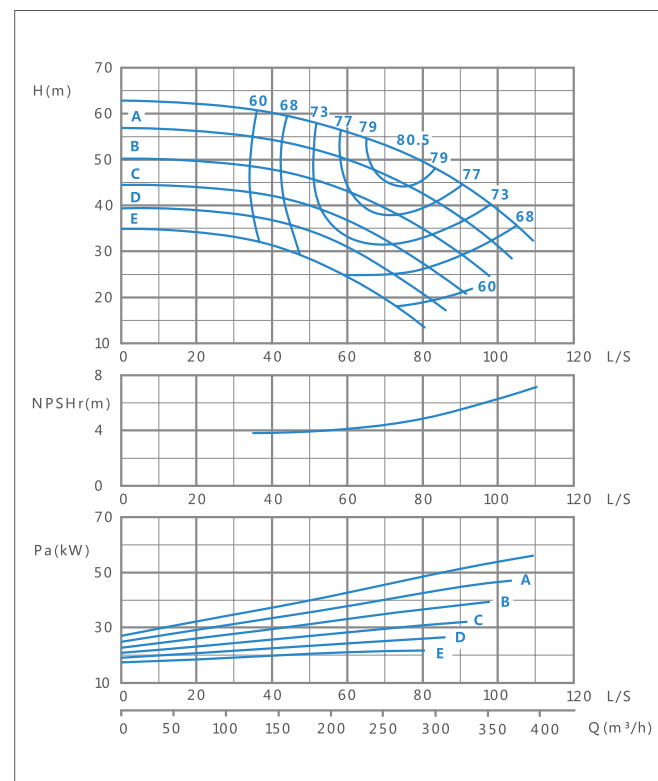

XA(T) 100/26-2900r/min Performance curve

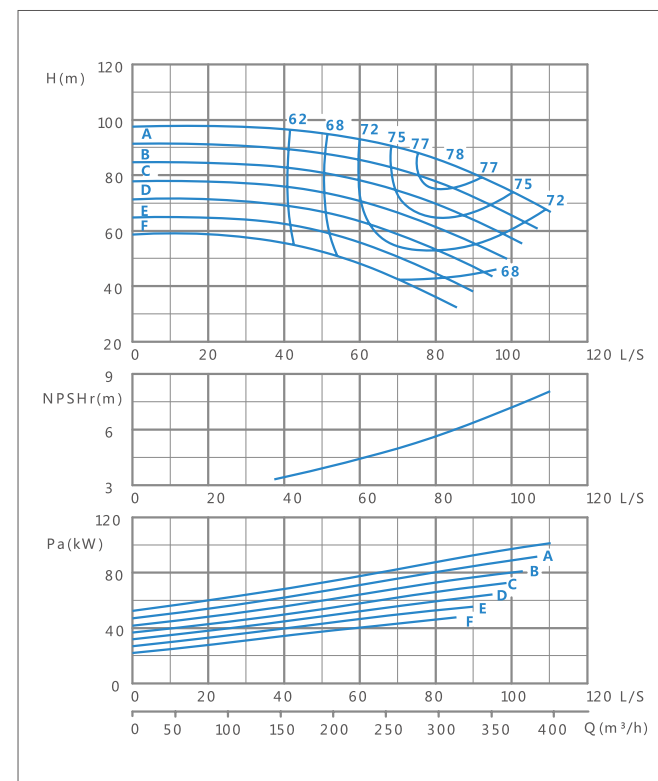

XA(T) 80/32-2900r/min Performance curve

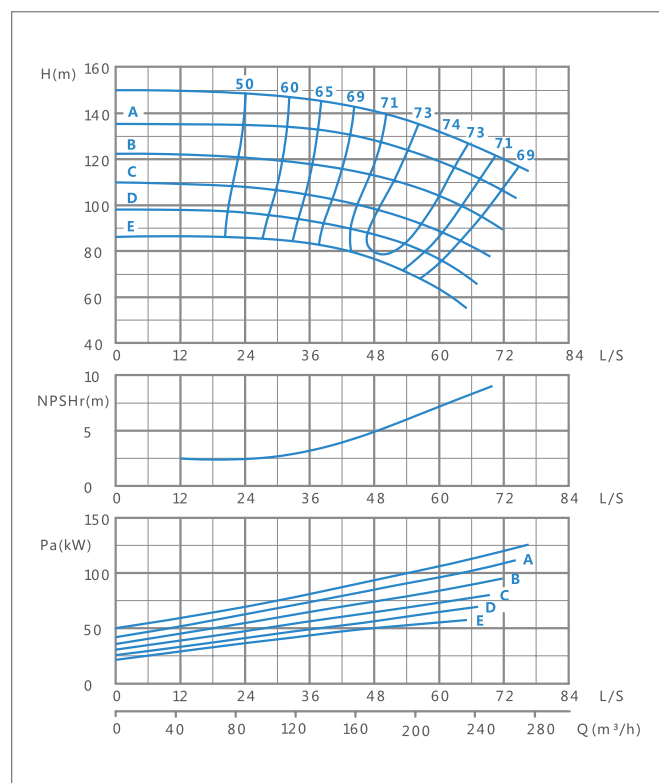

XA(T) 100/16-2900r/min Performance curve

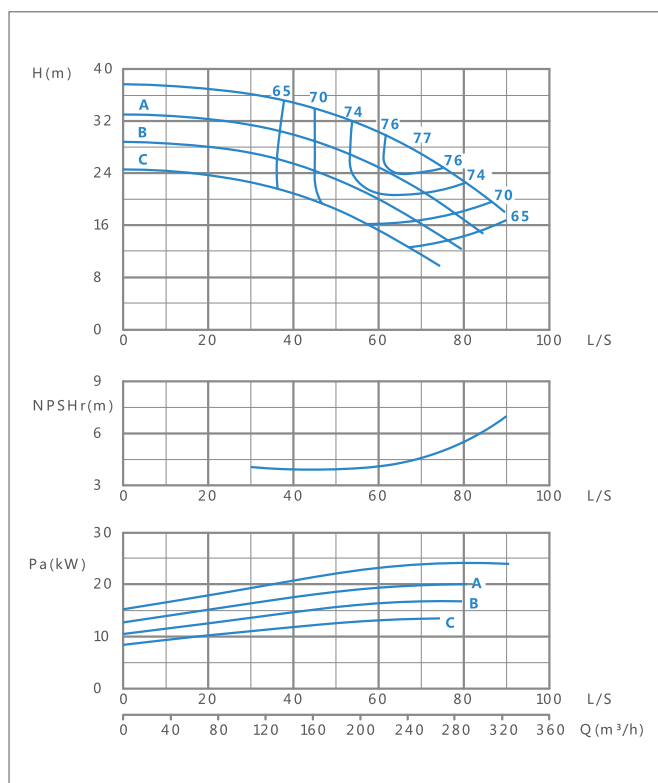

XA(T) 125/20-2900r/min Performance curve

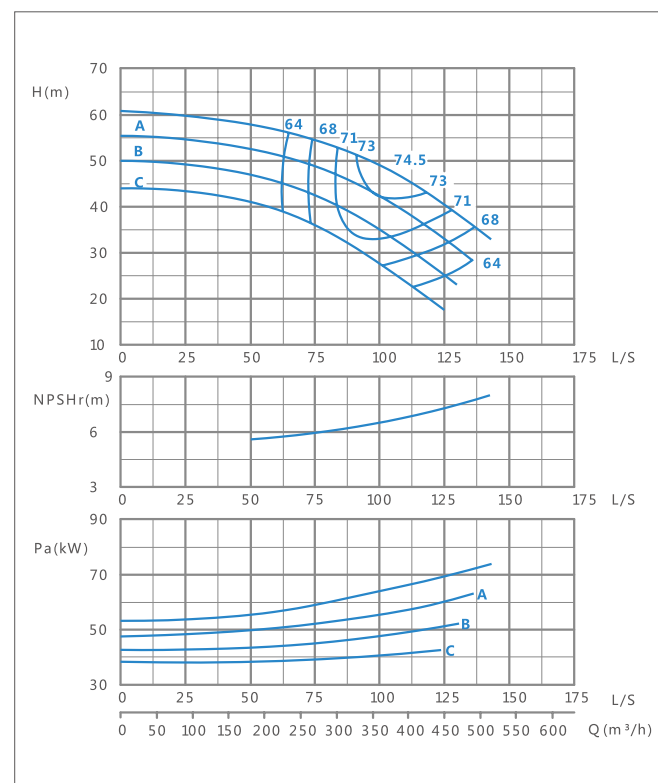

XA(T) 32/13-1450r/min Performance curve

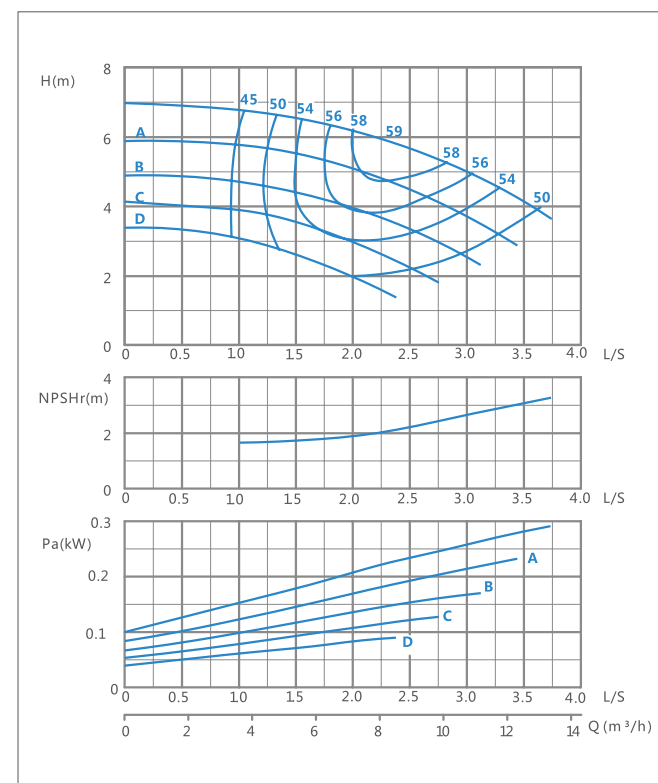

XA(T) 32/16-1450r/min Performance curve

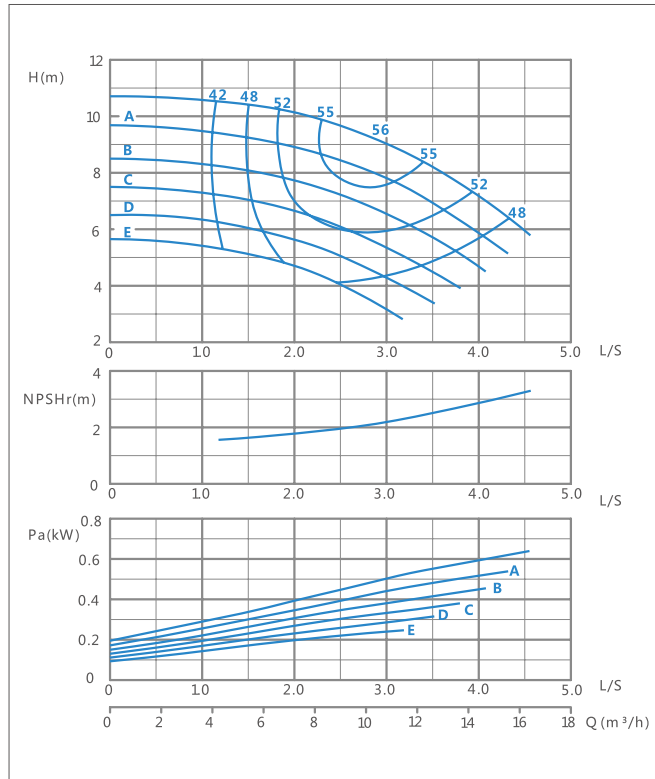

XA(T) 32/20-1450r/min Performance curve

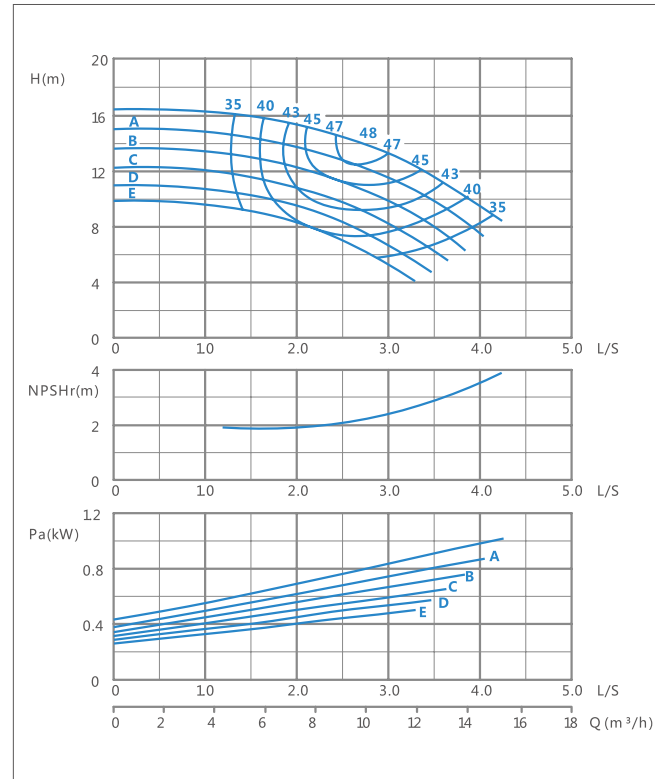

XA(T) 40/16-1450r/min Performance curve

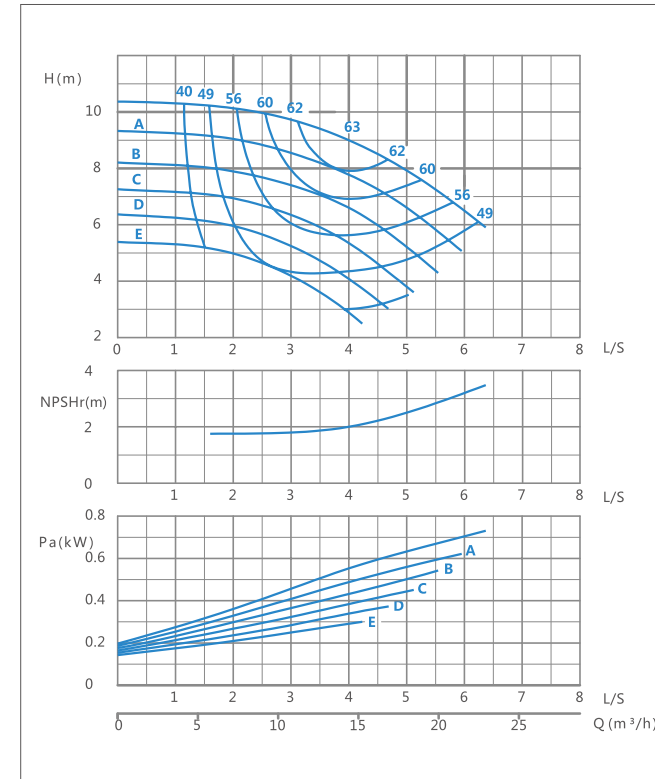

XA(T) 40/20-1450r/min Performance curve

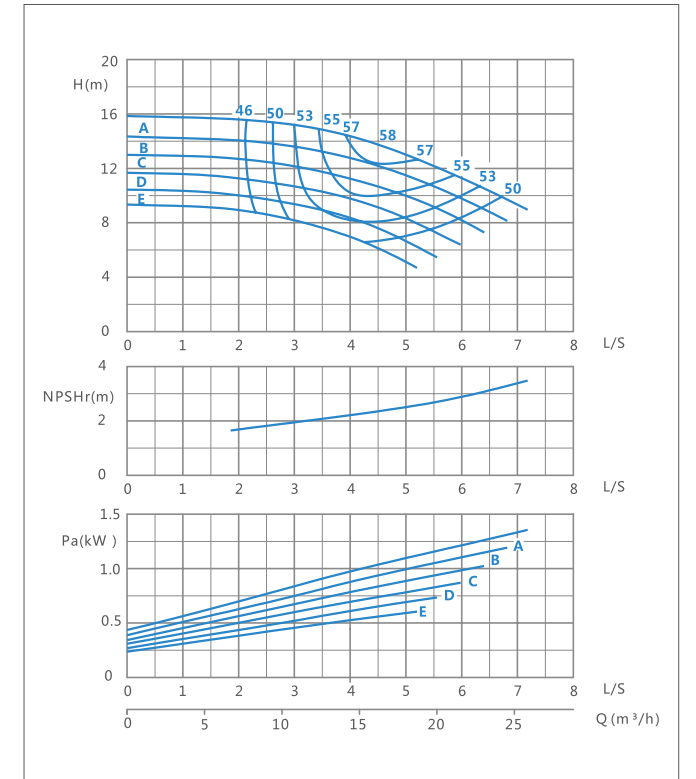

XA(T) 32/26-1450r/min Performance curve

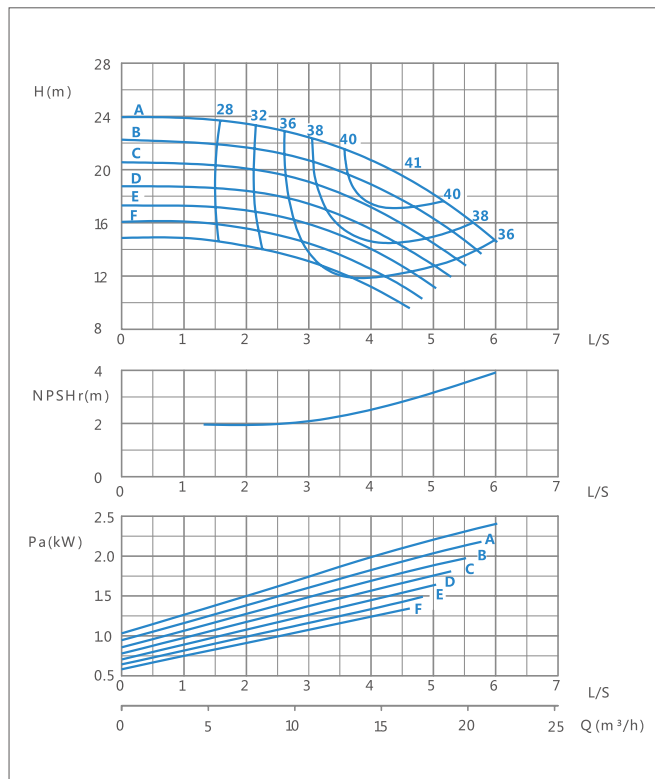

XA(T) 40/13-1450r/min Performance curve

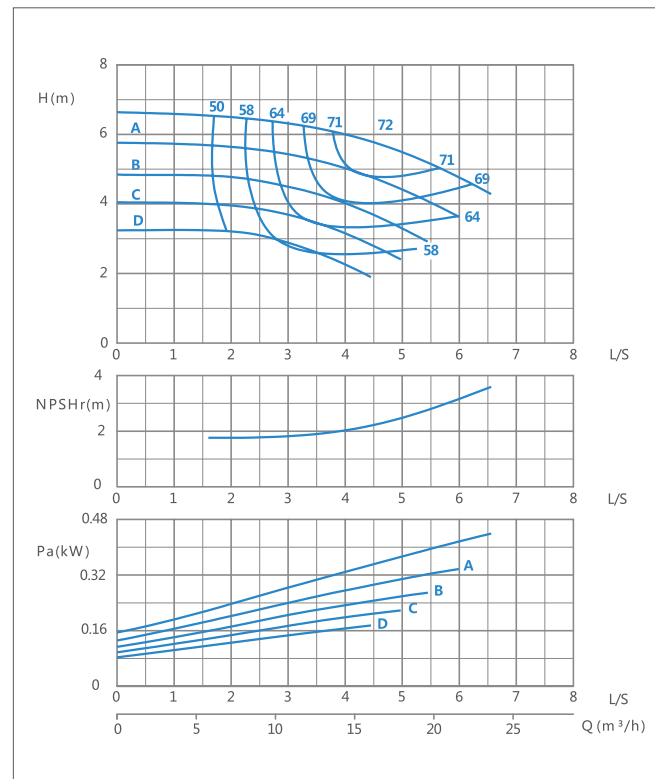

XA(T) 40/26-1450r/min Performance curve

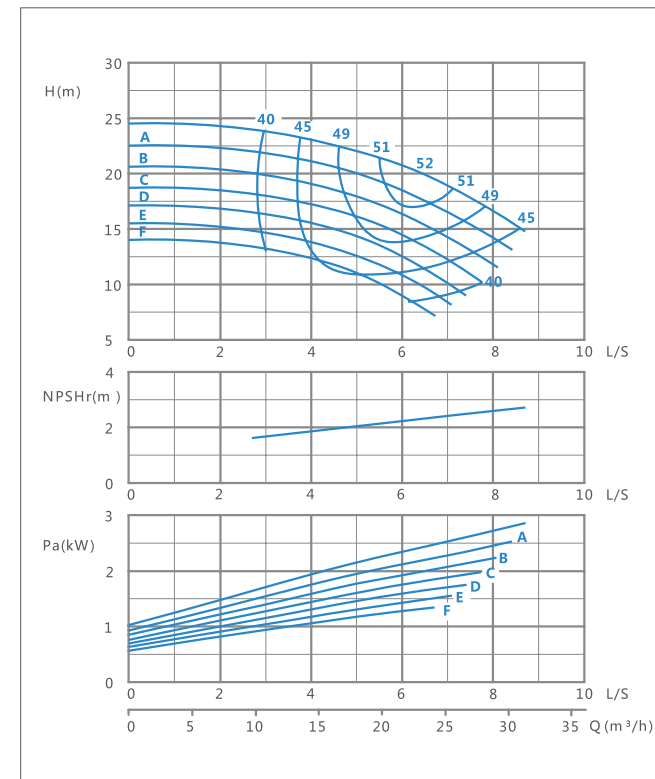

XA(T) 40/32-1450r/min Performance curve

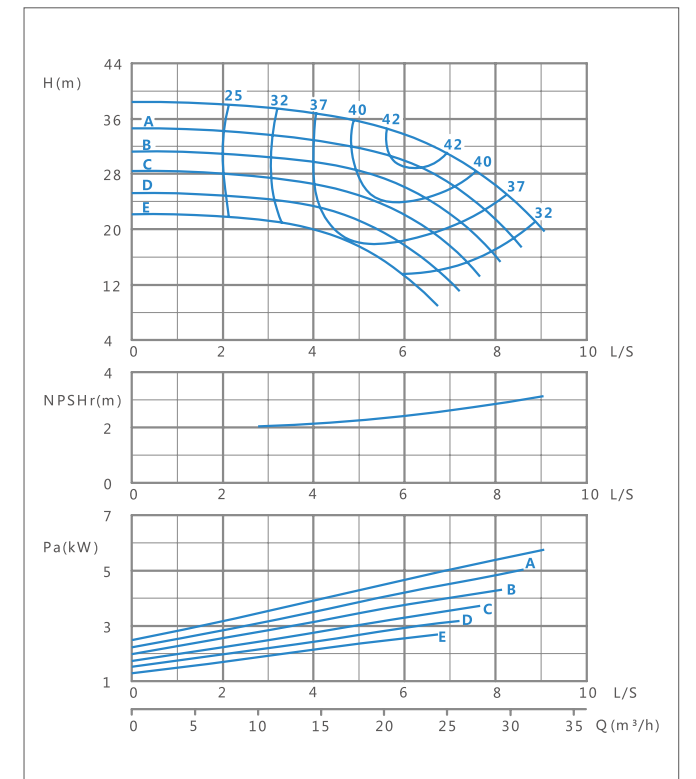

XA(T) 50/13-1450r/min Performance curve

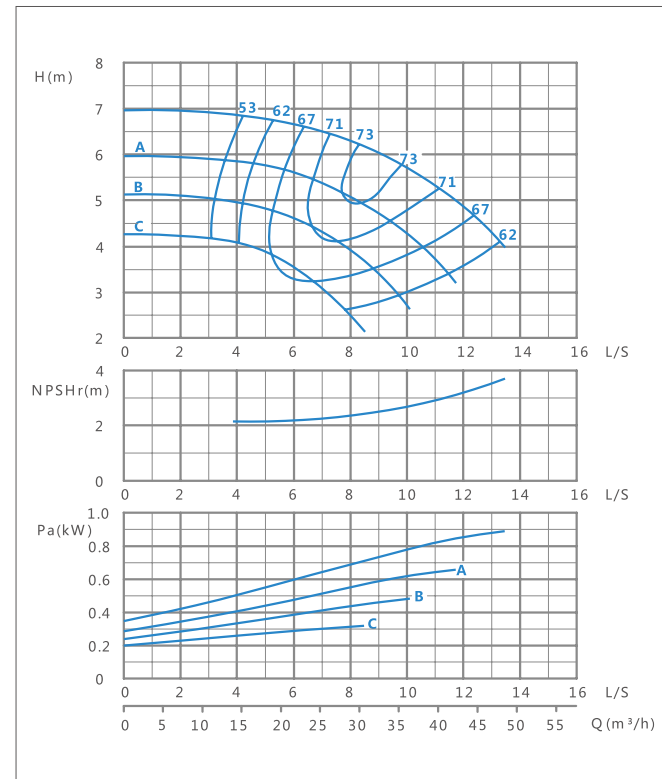

XA(T) 50/16-1450r/min Performance curve

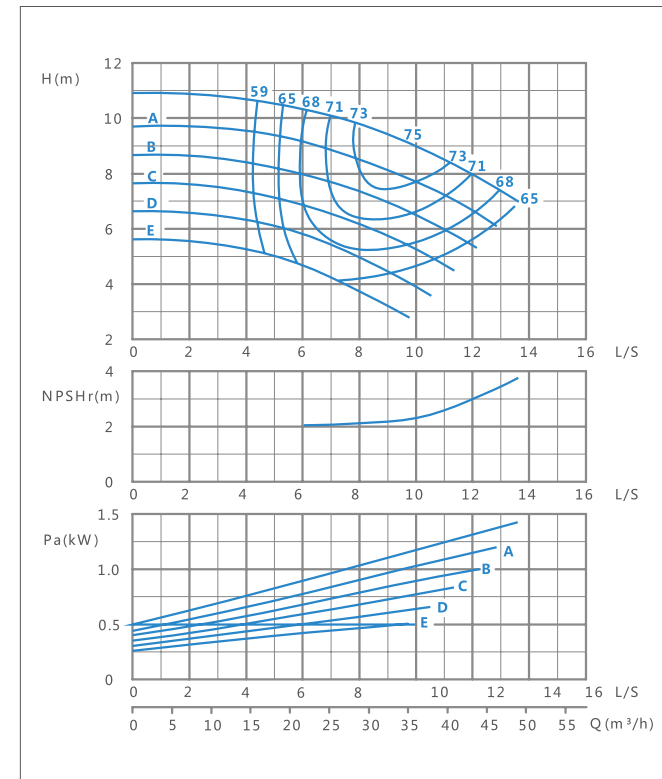

XA(T) 50/32-1450r/min Performance curve

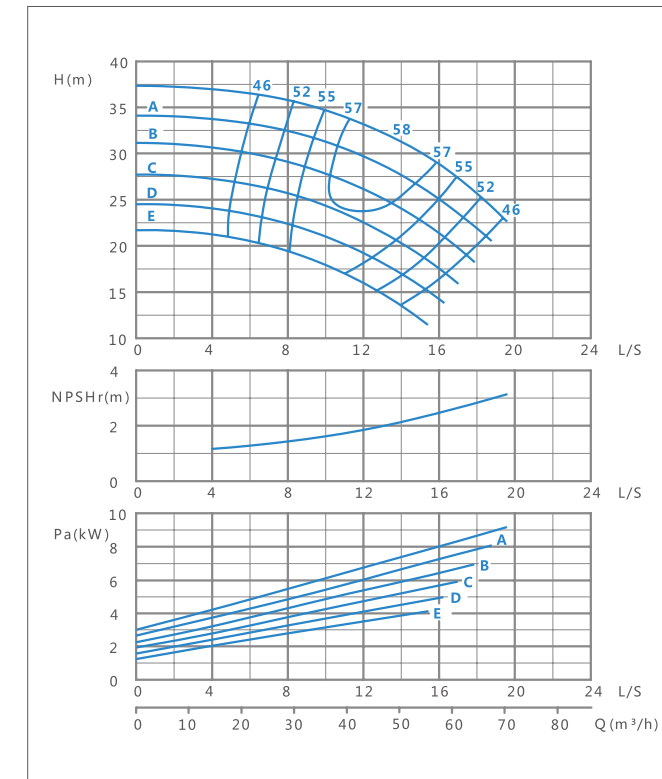

XA(T) 65/13-1450r/min Performance curve

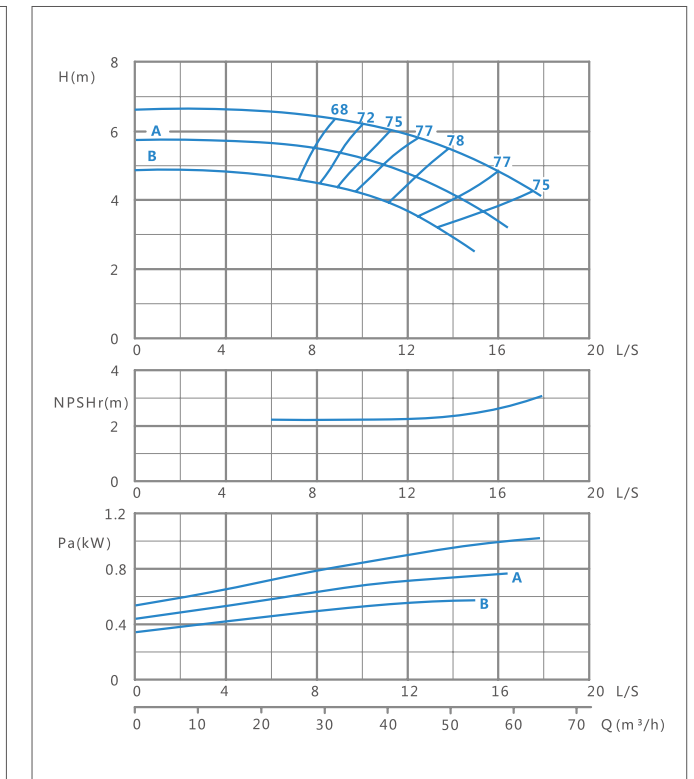

XA(T) 50/20-1450r/min Performance curve

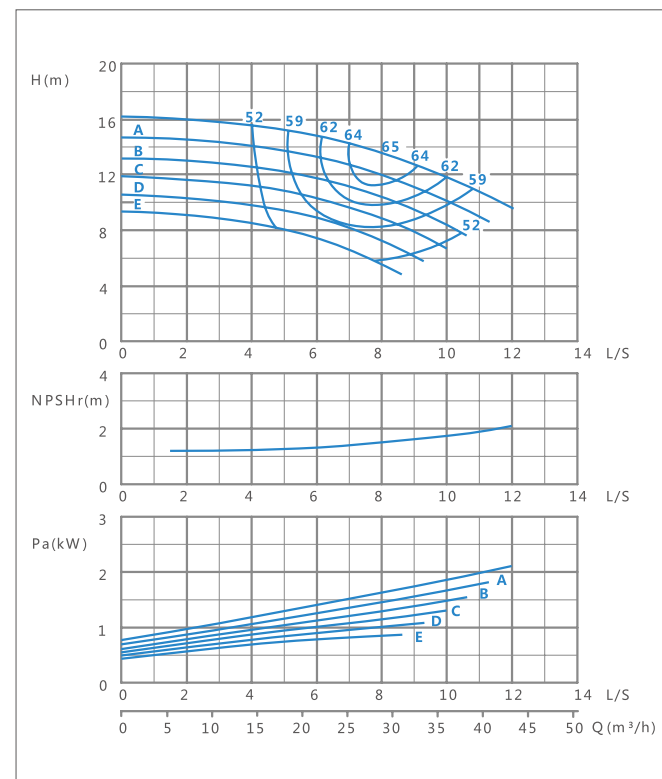

XA(T) 50/26-1450r/min Performance curve

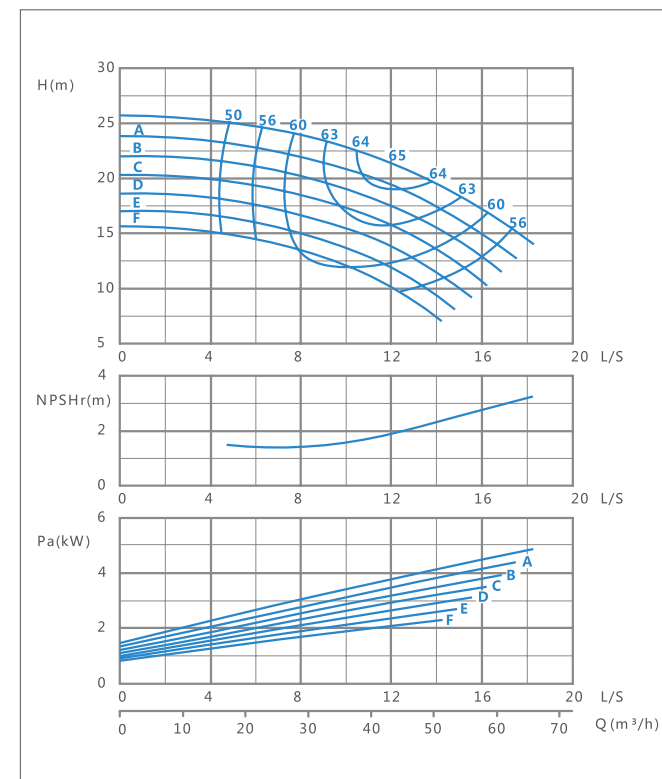

XA(T) 65/16-1450r/min Performance curve

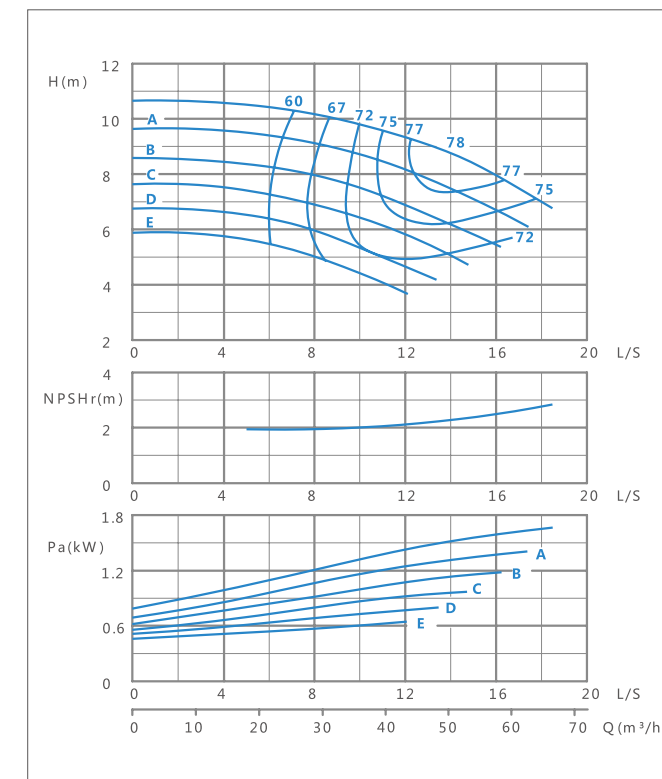

XA(T) 65/20-1450r/min Performance curve

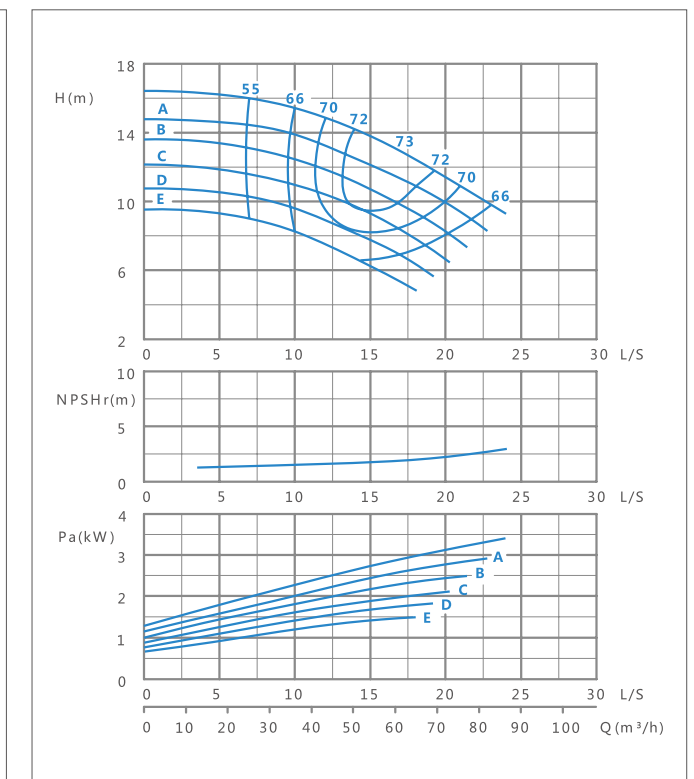

XA(T) 65/26-1450r/min Performance curve

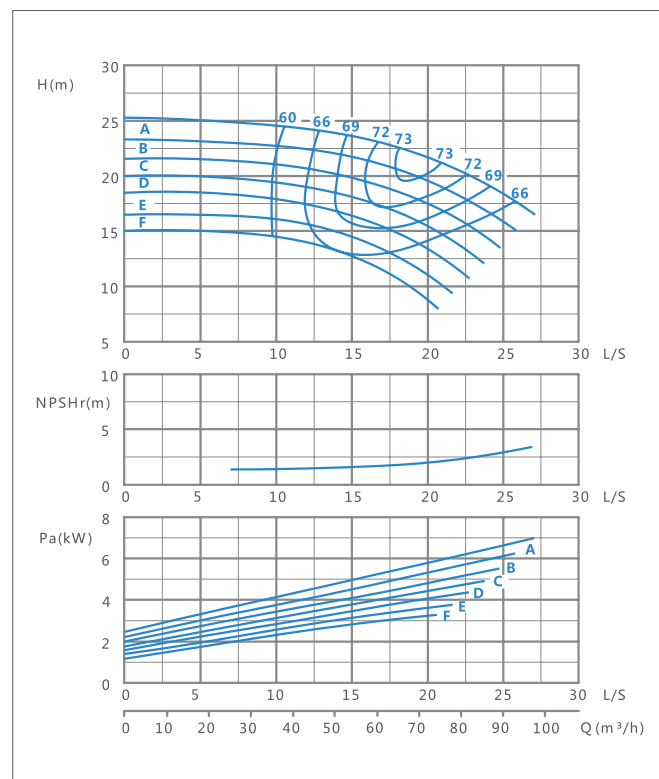

XA(T) 65/32-1450r/min Performance curve

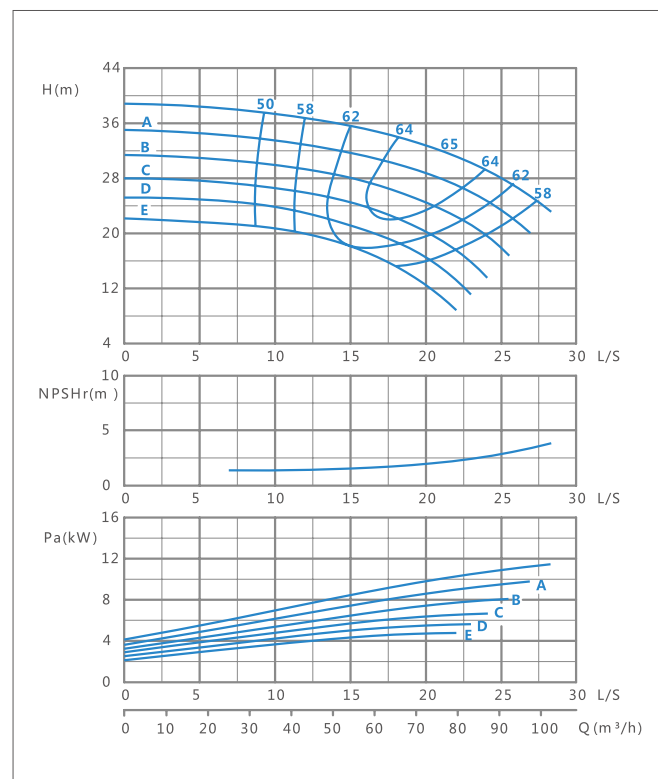

XA(T) 80/26-1450r/min Performance curve

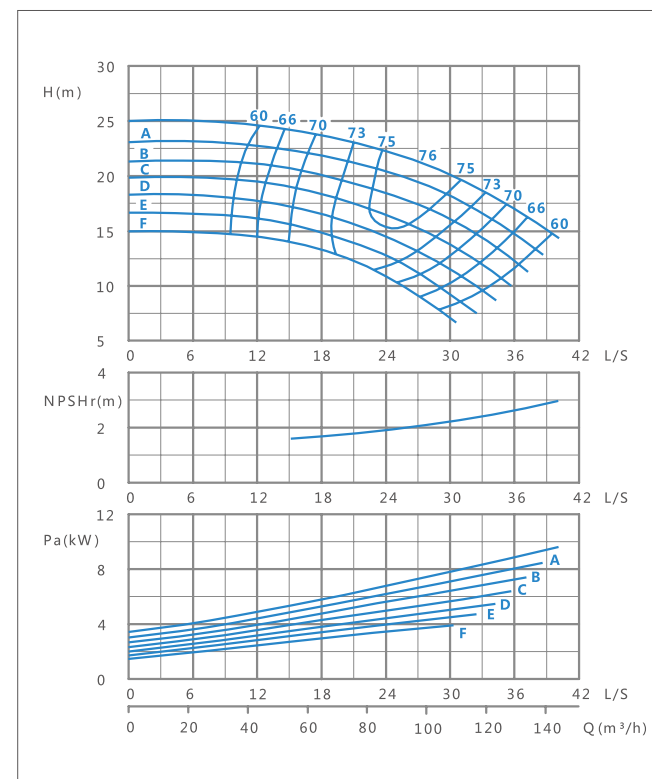

XA(T) 80/32-1450r/min Performance curve

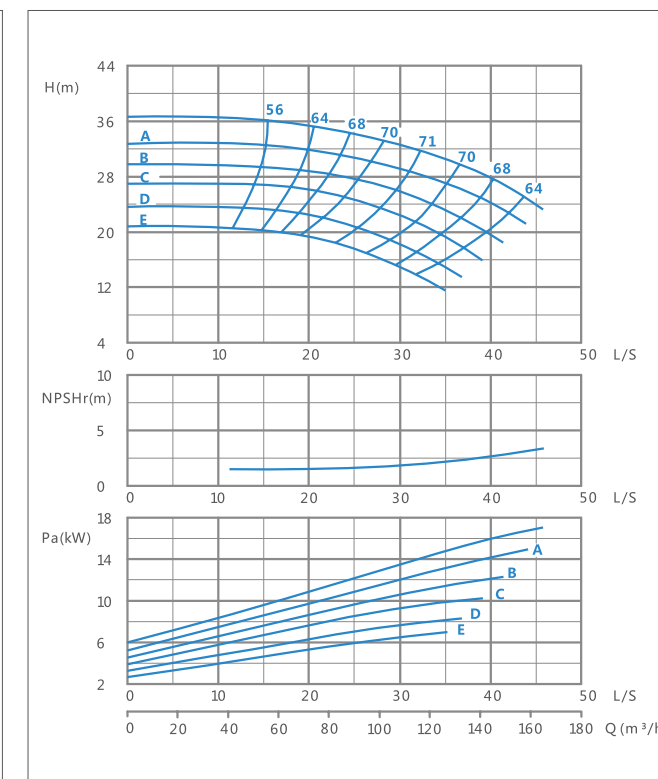

XA(T) 80/16-1450r/min Performance curve

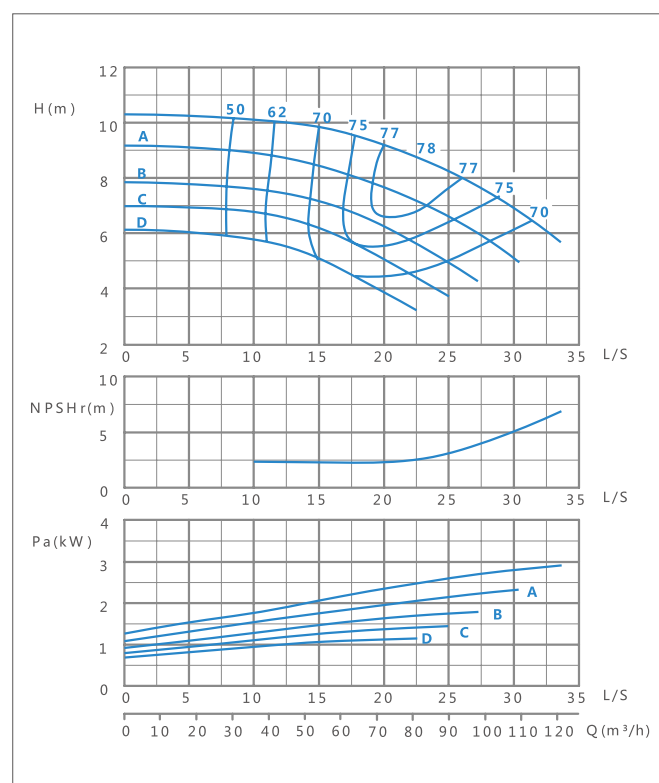

XA(T) 80/20-1450r/min Performance curve

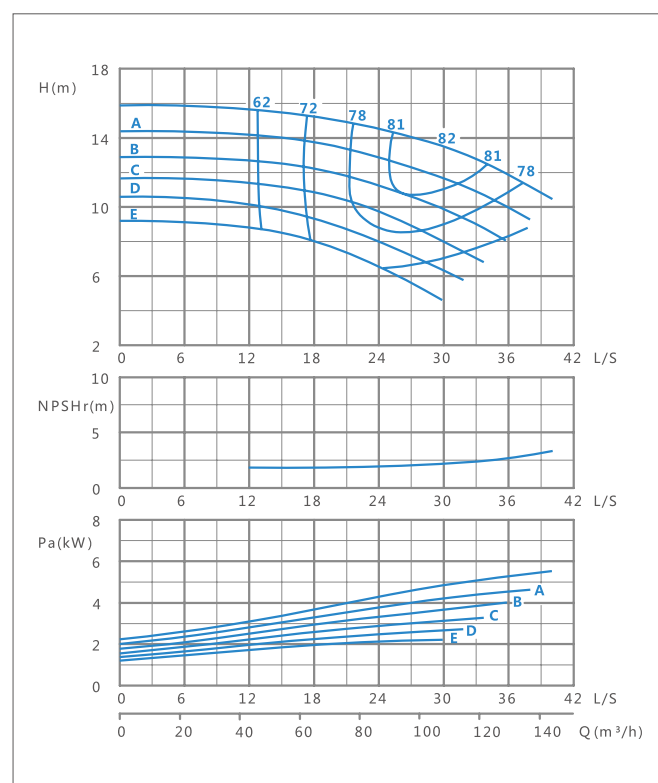

XA(T) 80/40-1450r/min Performance curve

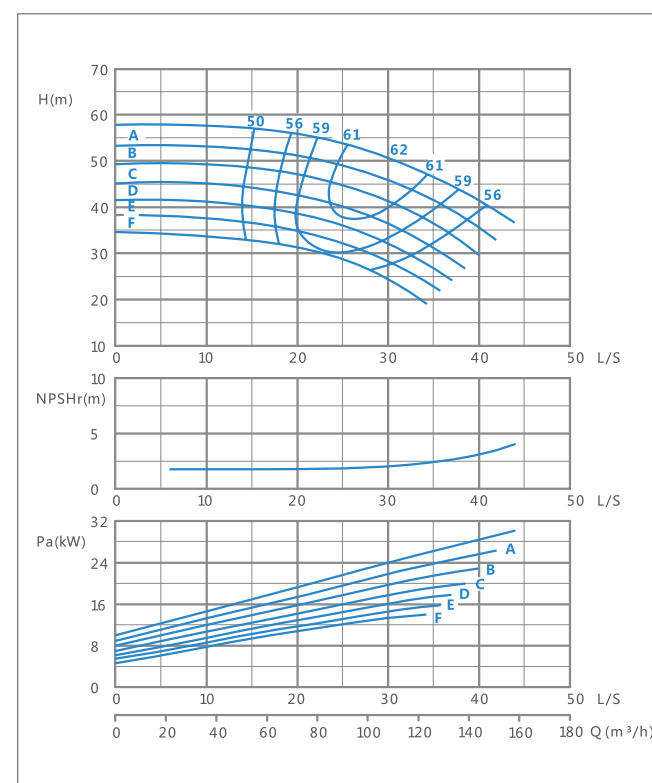

XA(T) 100/16-1450r/min Performance curve

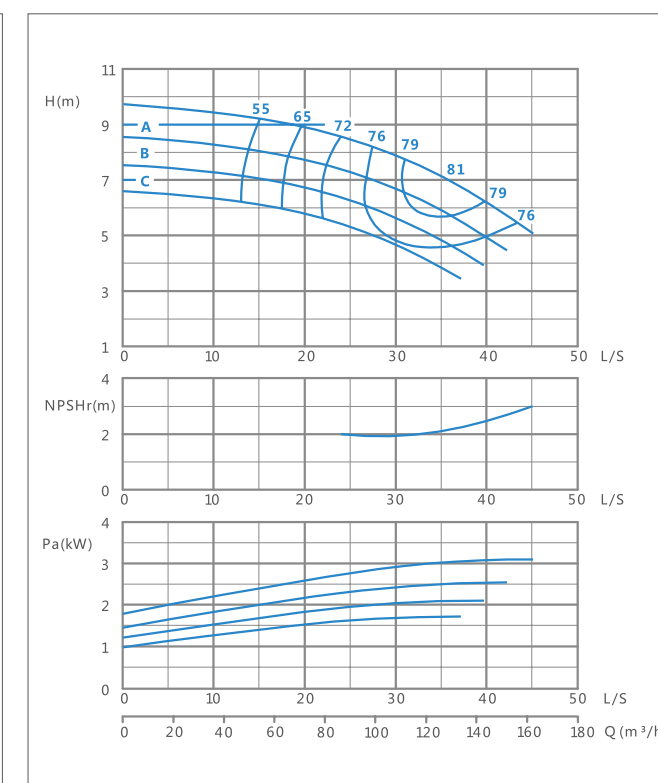

XA(T) 100/20-1450r/min Performance curve

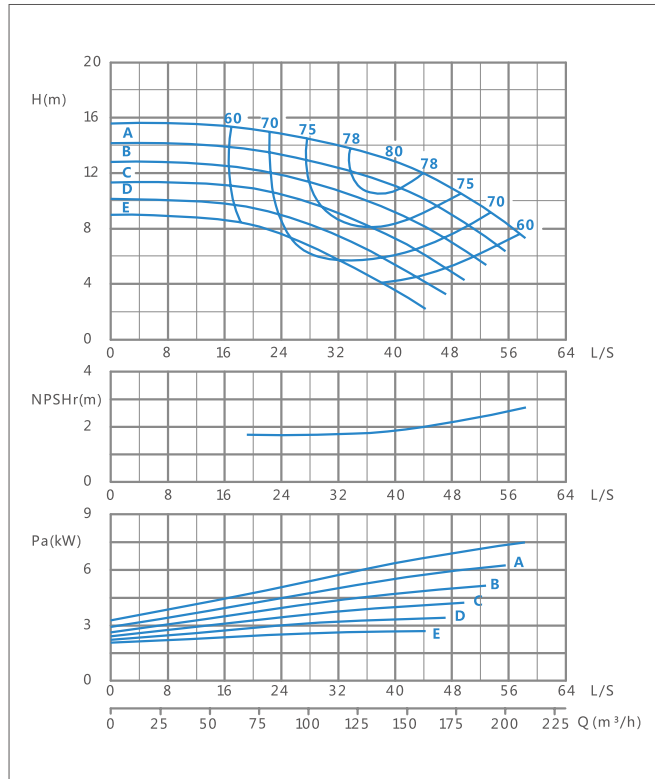

XA(T) 100/26-1450r/min Performance curve

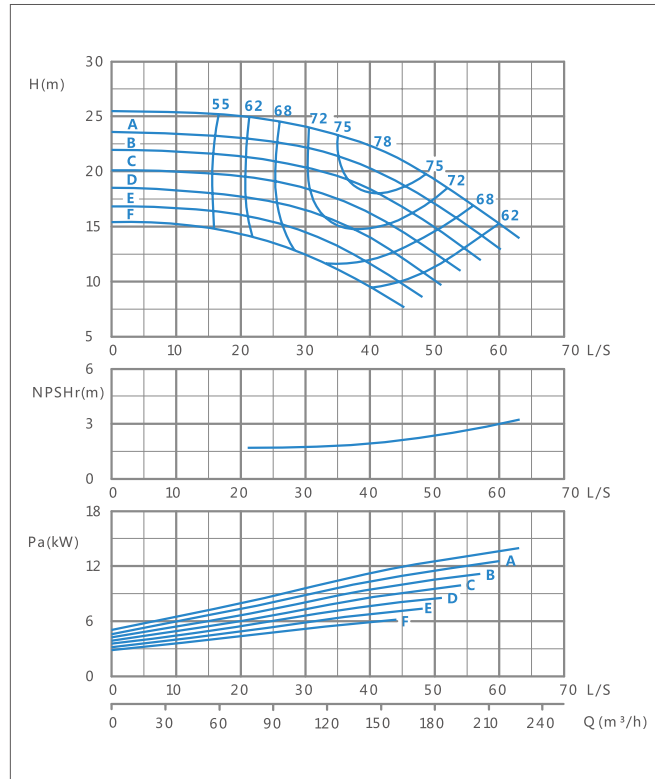

XA(T) 125/20-1450r/min Performance curve

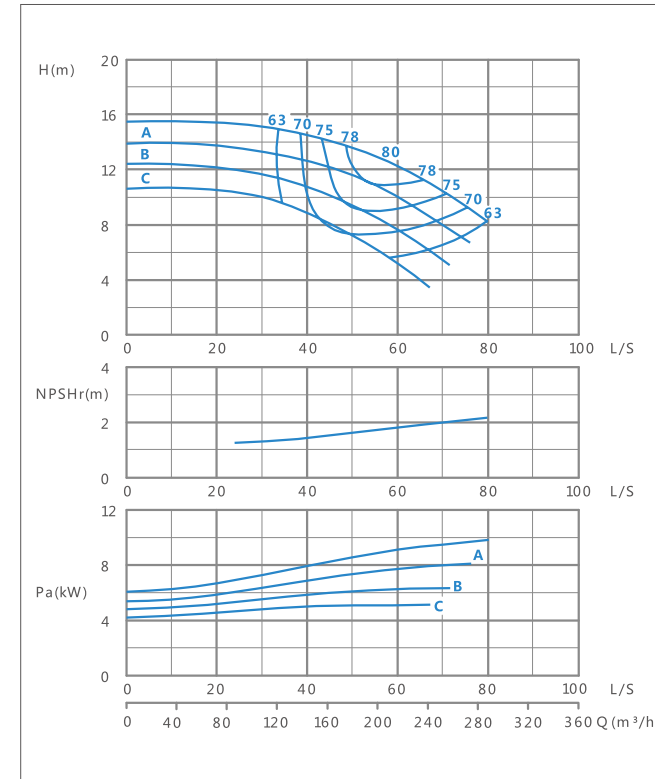

XA(T) 125/26-1450r/min Performance curve

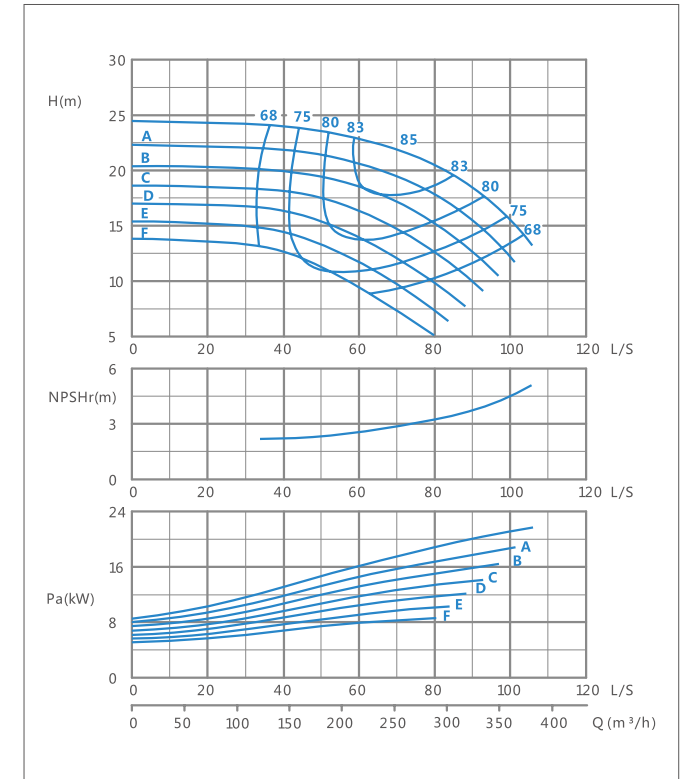

XA(T) 100/32-1450r/min Performance curve

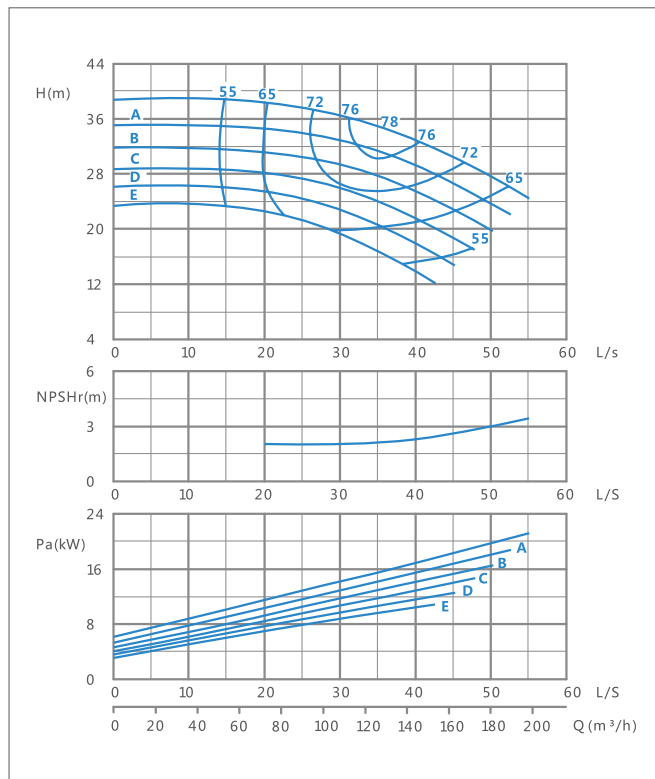

XA(T) 100/40-1450r/min Performance curve

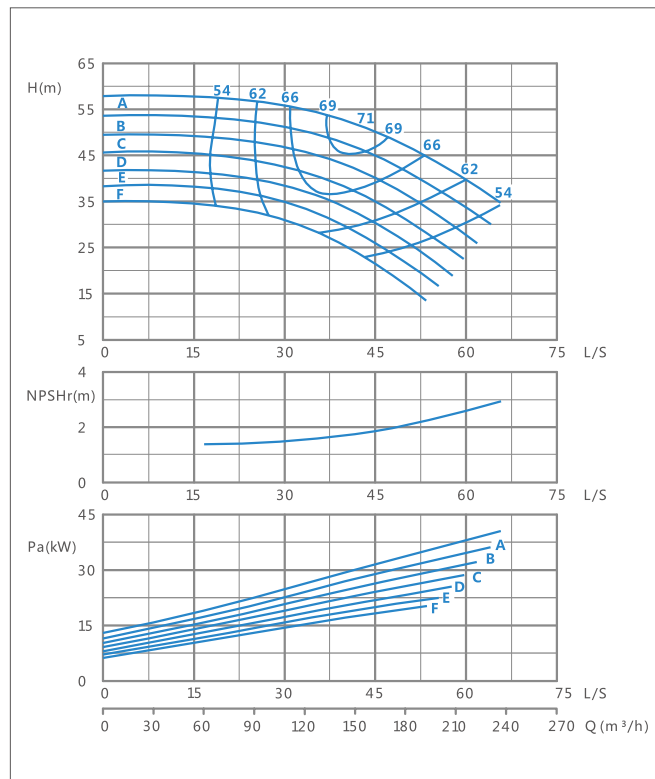

XA(T) 125/32-1450r/min Performance curve

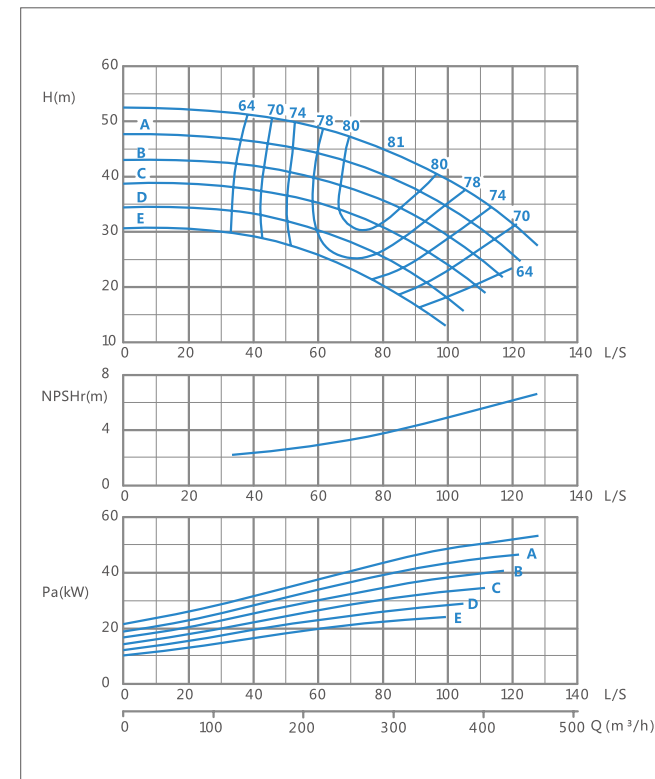

XA(T) 125/40-1450r/min Performance curve

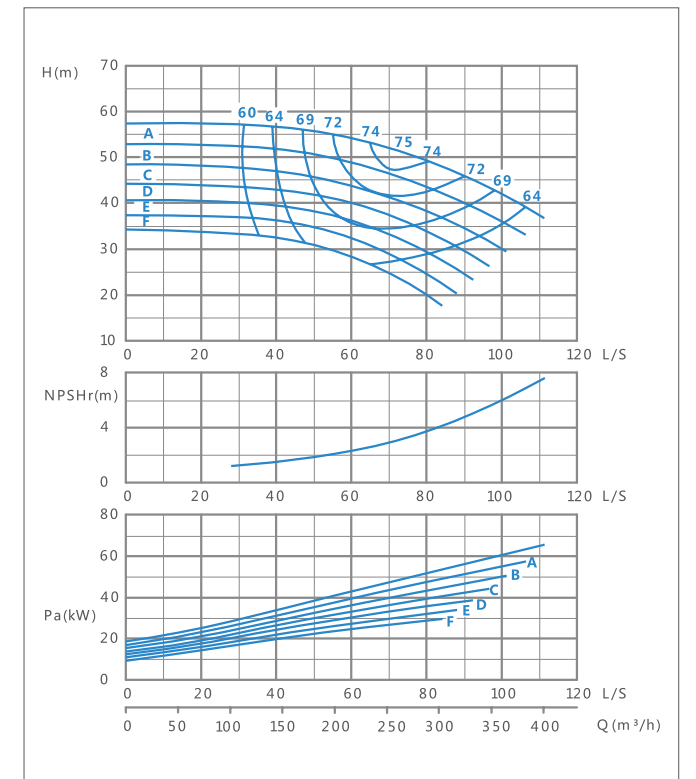

XA(T) 125/50-1450r/min Performance curve

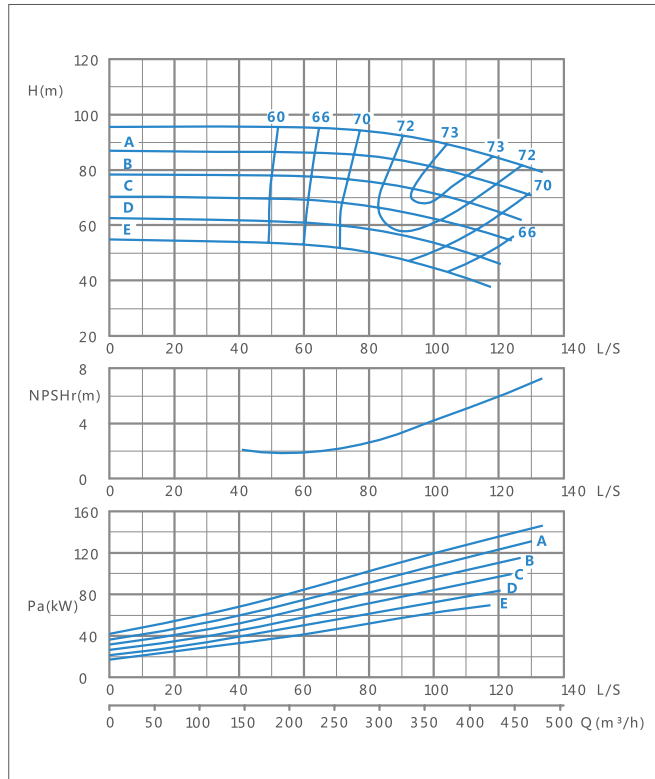

XA(T) 150/20-1450r/min Performance curve

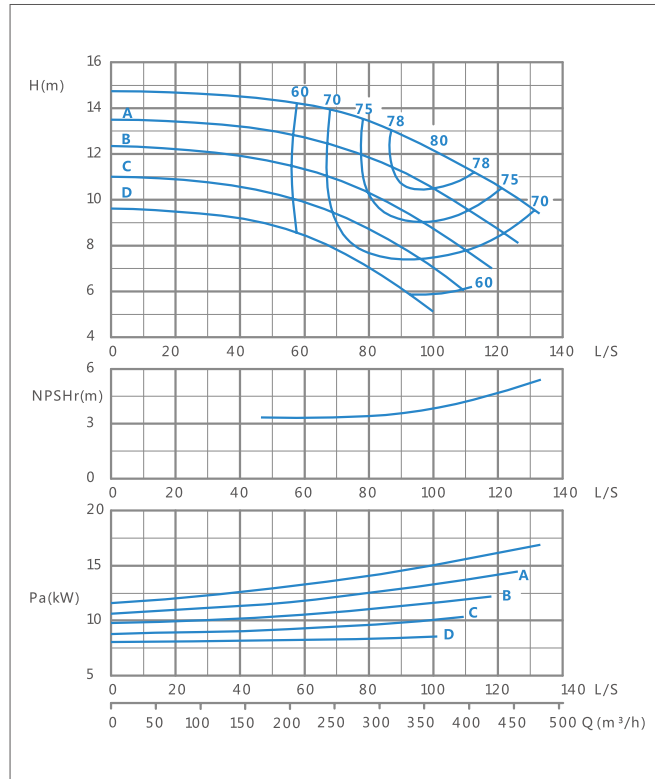

XA(T) 150/40-1450r/min Performance curve

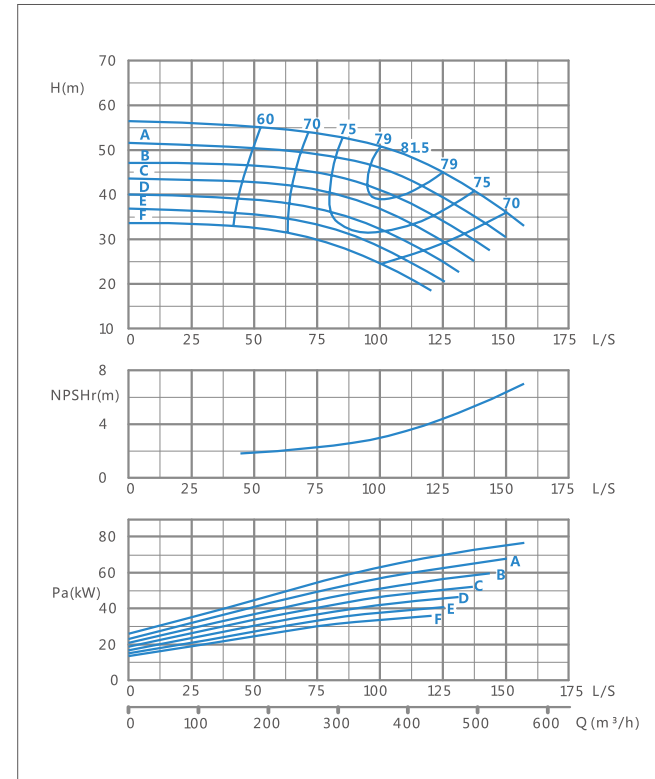

XA150/50-1450r/min Performance curve

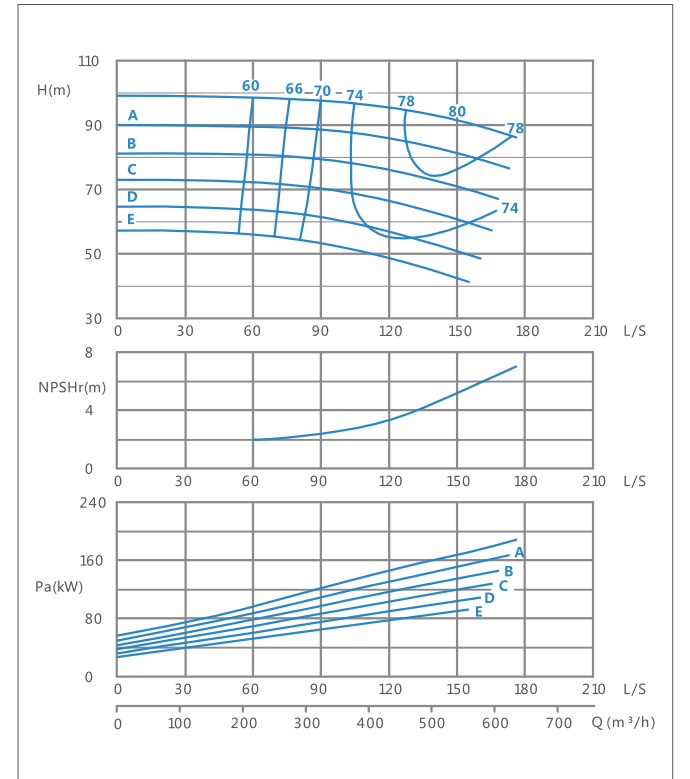

XA(T) 150/26-1450r/min Performance curve

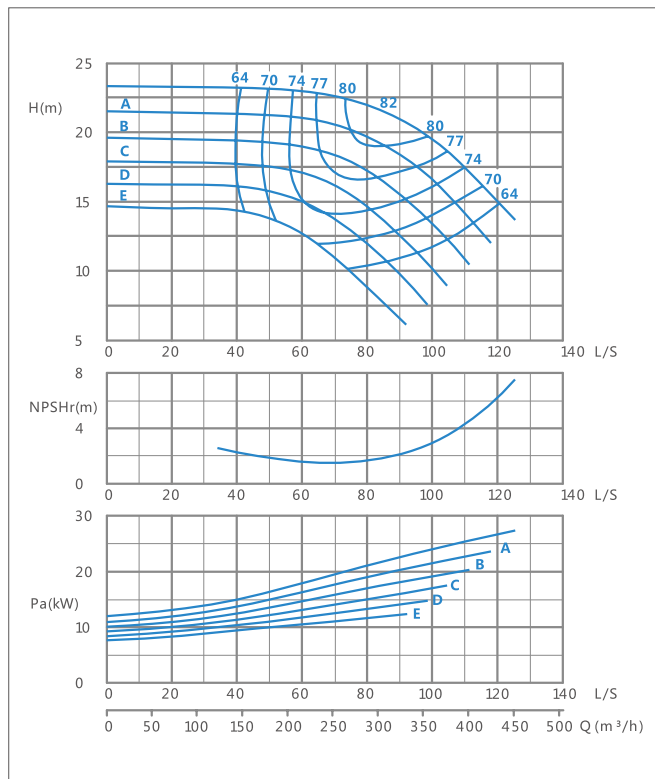

XA(T) 150/32-1450r/min Performance curve

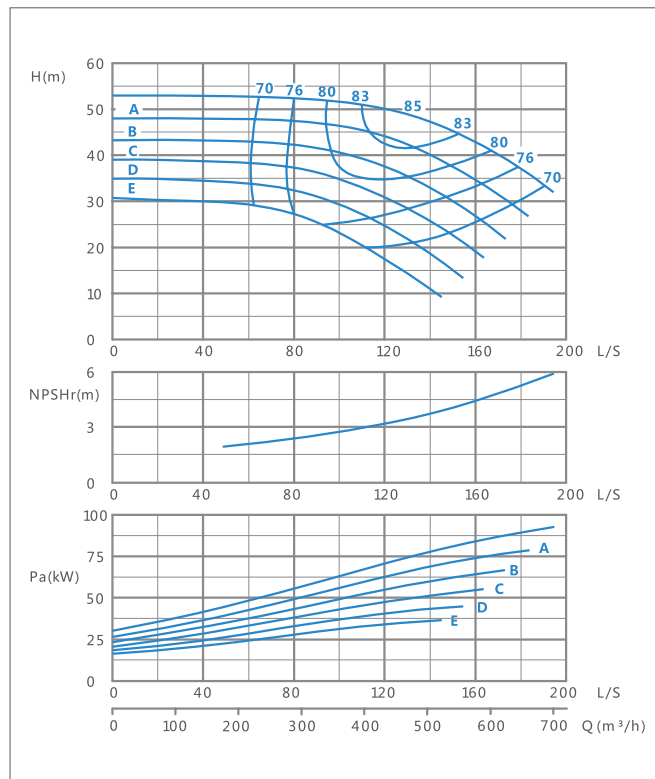

XA200/26-1450r/min Performance curve

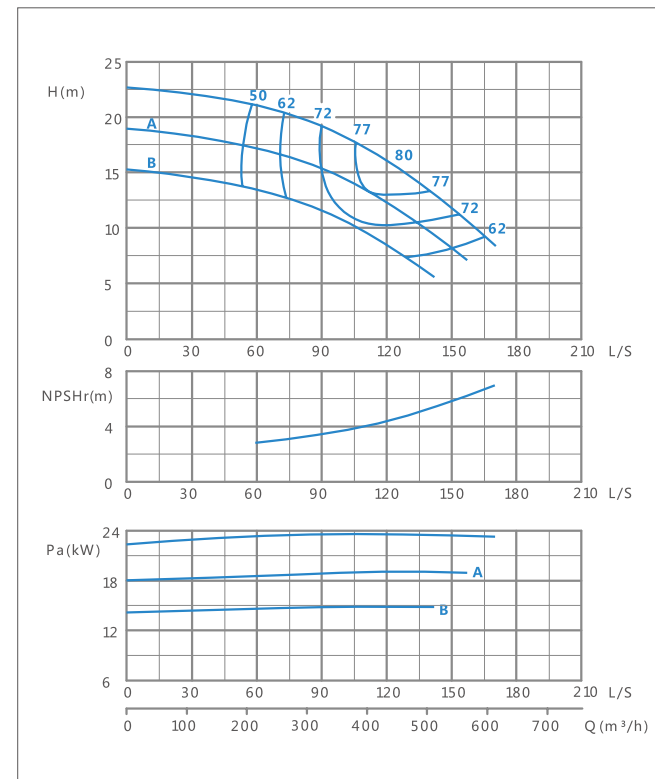

XA200/32-1450r/min Performance curve

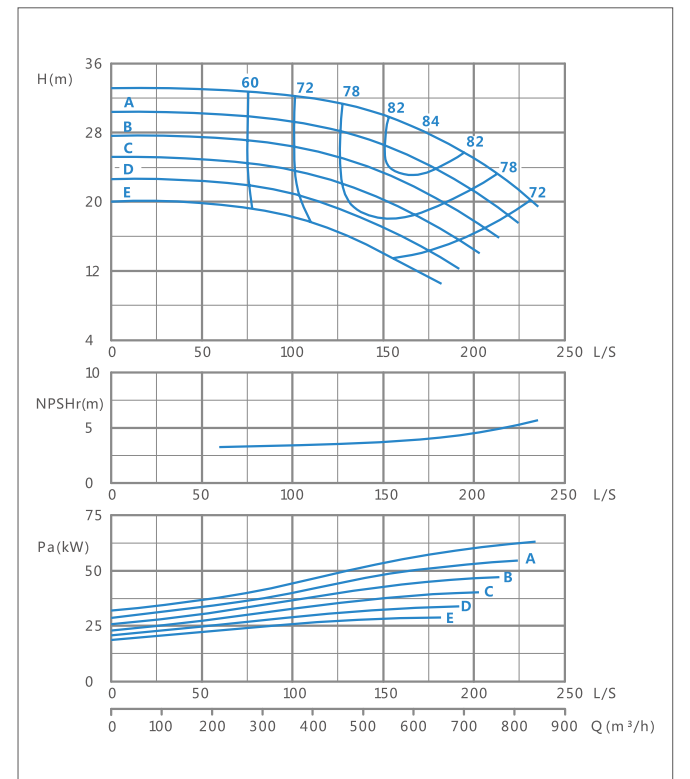

XA200/40-1450r/min Performance curve

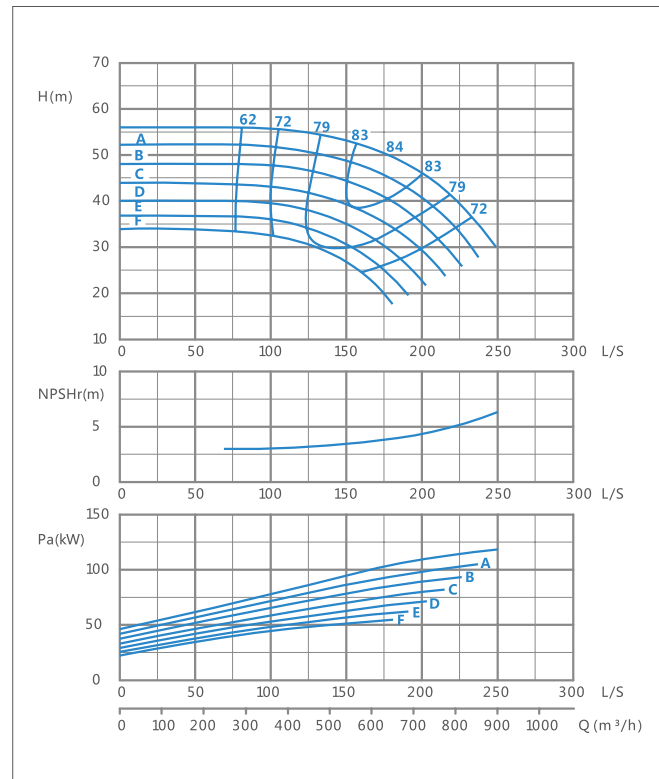

XA200/50-1450r/min Performance curve

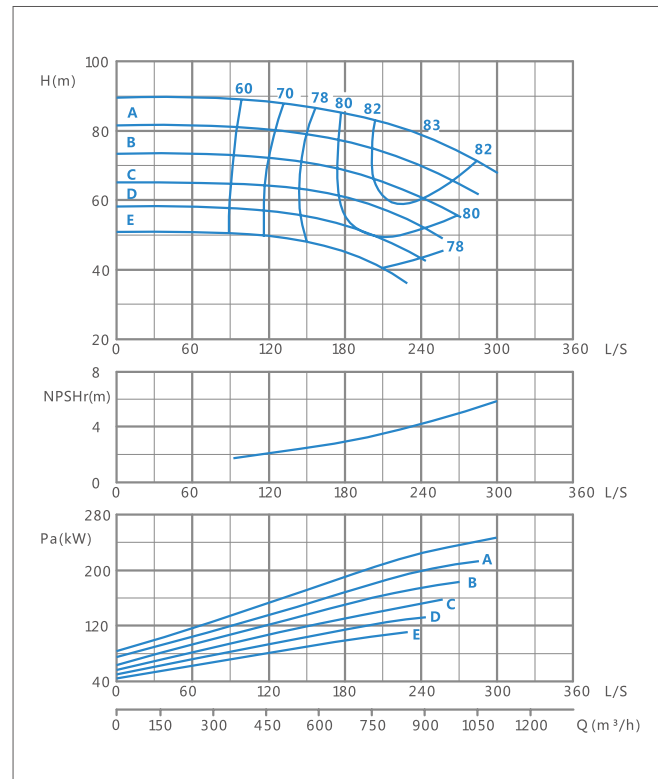

XA250/50-1450r/min Performance curve

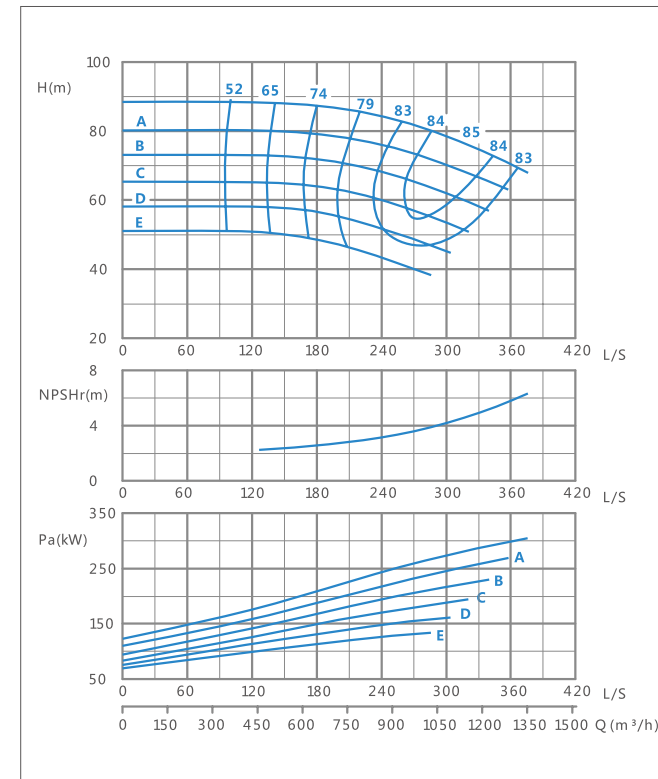

XA300/40-1450r/min Performance curve

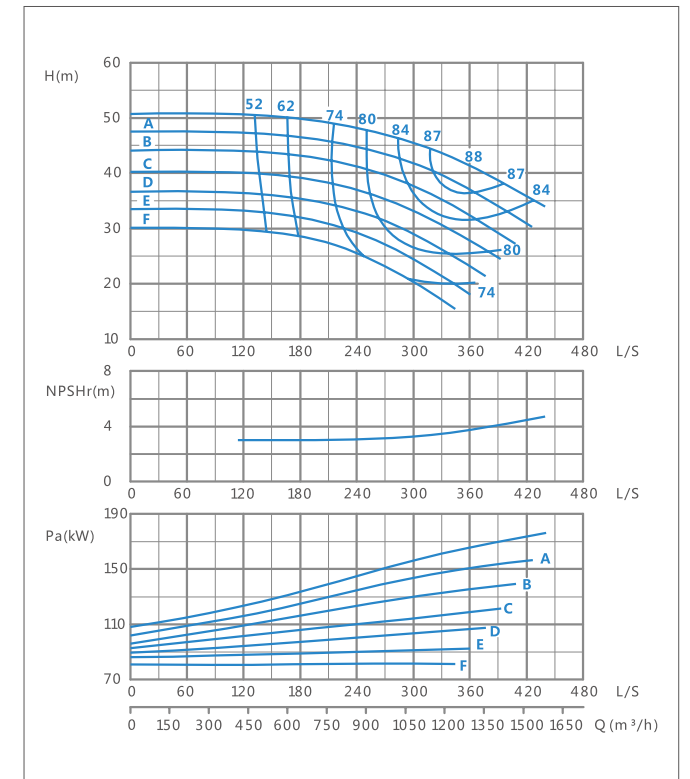

XA250/32-1450r/min Performance curve

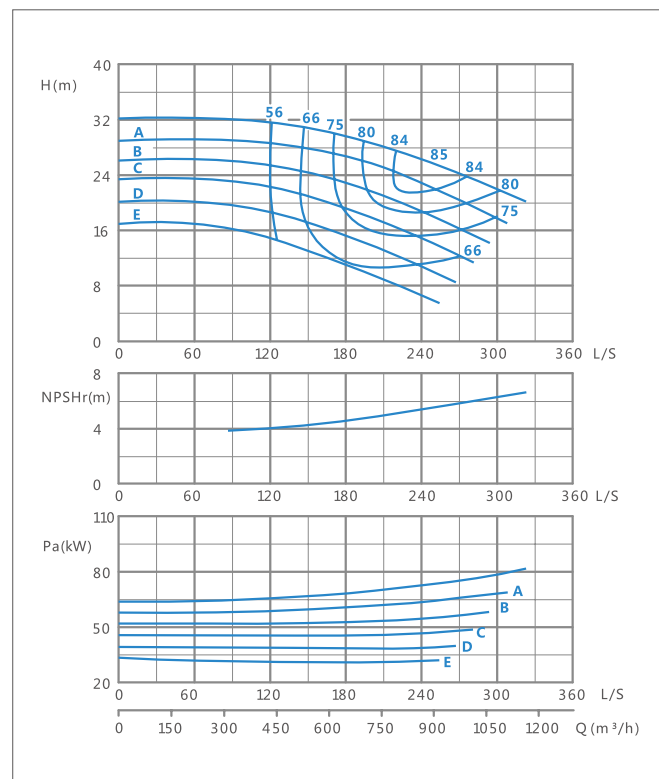

XA250/40-1450r/min Performance curve

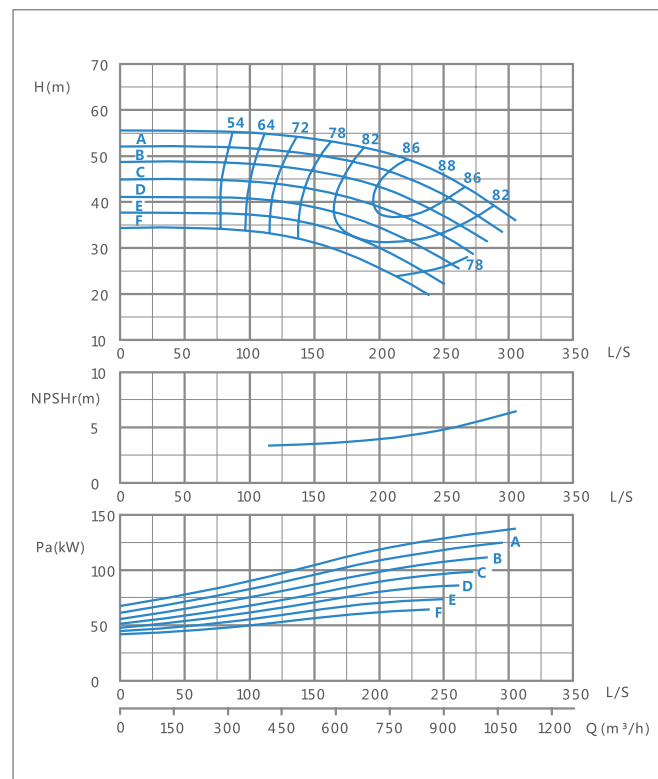

Technical Parameter

Model	Capacity		Head (m)	Speed (r/min)	Eff. (%)	Motor power (kW)	NPSHr (mm)
	m³/h	L/s					
XA(T)32/13	9.0	2.5	26.0	2900	52.0	1.5	1.4
	15.0	4.2	24.0		61.0	2.2	1.7
	18.0	5.0	22.5		62.0	2.2	2.5
XA(T)32/13A	8.4	2.3	22.0	2900	51.5	1.5	1.4
	14.0	3.9	19.7		60.0	1.5	1.7
	16.8	4.7	18.0		60.5	2.2	2.5
XA(T)32/13B	7.8	2.2	18.0	2900	51.0	1.1	1.4
	13.0	3.6	16.2		58.5	1.1	1.7
	15.6	4.3	14.5		58.0	1.5	2.5
XA(T)32/13C	7.1	2.0	14.8	2900	50.0	1.1	1.4
	11.9	3.3	13.0		57.0	1.1	1.7
	14.3	4.0	11.4		55.5	1.1	2.5
XA(T)32/13D	6.5	1.8	11.7	2900	48.0	0.75	1.4
	10.8	3.0	10.1		52.0	0.75	1.7
	13.0	3.6	8.7		52.0	1.1	2.5
XA(T)32/16	10.8	3.0	42.0	2900	46.5	3	1.9
	18.0	5.0	39.0		56.0	4	2.2
	21.6	6.0	36.5		56.7	5.5	3.7
XA(T)32/16A	10.2	2.8	37.0	2900	45.5	3	1.9
	17.1	4.7	34.6		55.5	3	2.2
	20.5	5.7	32.1		56.3	4	3.7
XA(T)32/16B	9.6	2.7	32.3	2900	44.0	3	1.9
	16.0	4.5	30.5		54.5	3	2.2
	19.2	5.3	28.7		56.0	4	3.7
XA(T)32/16C	9.0	2.5	28.3	2900	43.0	2.2	1.9
	15.0	4.2	26.5		53.0	3	2.2
	18.0	5.0	25.0		54.5	3	3.7
XA(T)32/16D	8.4	2.3	24.6	2900	40.0	2.2	1.9
	14.0	3.9	22.7		51.0	2.2	2.2
	16.8	4.7	21.4		52.5	2.2	3.7
XA(T)32/16E	7.8	2.2	20.5	2900	39.0	1.1	1.9
	12.9	3.6	19.2		48.5	2.2	2.2
	15.5	4.3	18.0		51.0	2.2	3.7
XA(T)32/20	10.8	3.0	64.2	2900	39.0	5.5	1.7
	18.0	5.0	58.5		48.4	7.5	2.0
	21.6	6.0	54.1		48.3	11	2.3
XA(T)32/20A	10.3	2.9	58.3	2900	38.6	5.5	1.6
	17.2	4.8	53.0		48.2	7.5	2.0
	20.7	5.7	48.3		48.1	7.5	2.2
XA(T)32/20B	9.8	2.7	52.2	2900	38.6	5.5	1.6
	16.4	4.6	47.7		47.5	7.5	2.0
	19.7	5.5	43.2		47.0	7.5	2.2
XA(T)32/20C	9.3	2.6	47.2	2900	37.0	4	1.6
	15.6	4.3	42.5		46.5	5.5	2.0
	18.7	5.2	38.2		46.0	5.5	2.2
XA(T)32/20D	8.8	2.5	42.2	2900	36.0	4	1.6
	14.7	4.1	38.0		45.0	5.5	2.0
	17.7	4.9	34.2		44.2	5.5	2.2
XA(T)32/20E	8.3	2.3	37.5	2900	35.5	2.2	1.6
	13.9	3.9	33.8		43.0	4	2.0
	16.7	4.6	30.4		43.4	4	2.2

Model	Capacity		Head (m)	Speed (r/min)	Eff. (%)	Motor power (kW)	NPSHr (mm)
	m³/h	L/s					
XA(T)32/26	16.2	4.5	89.3	2900	33.5	15	2.1
	27.0	7.5	82.0		41.5	19	2.6
	32.4	9.0	75.3		40.8	18.5	3.1
XA(T)32/26A	15.6	4.3	83.6	2900	33.0	15	2.1
	26.1	7.2	76.0		40.3	15	2.6
	31.3	8.7	70.5		40.5	18.5	3.1
XA(T)32/26B	15.0	4.2	77.5	2900	31.0	15	2.1
	25.1	7.0	70.2		39.5	15	2.6
	30.1	8.4	65.0		40.2	15	3.1
XA(T)32/26C	14.4	4.0	72.0	2900	31.0	15	2.1
	24.0	6.7	65.0		39.0	15	2.6
	28.8	8.0	59.8		40.0	15	3.1
XA(T)32/26D	13.8	3.8	66.0	2900	30.5	11	2.1
	23.0	6.4	59.6		37.5	15	2.6
	27.6	7.7	54.8		38.0	15	3.1
XA(T)32/26E	13.2	3.7	60.8	2900	30.0	11	2.1
	22.0	6.1	55.0		36.2	11	2.6
	26.4	7.3	51.0		37.0	11	3.1
XA(T)32/26F	12.6	3.5	58.0	2900	28.5	11	2.1
	21.0	5.8	50.8		34.5	11	2.6
	25.2	7.0	46.2		35.0	11	3.1
XA(T)40/13	18.0	5.0	25.3	2900	61.0	2.2	1.8
	30.0	8.3	23.5		73.0	3	2.0
	36.0	10.0	21.8		73.5	4	3.0
XA(T)40/13A	16.8	4.7	22.0	2900	62.0	2.2	1.8
	28.0	7.8	20.2		73.2	3	2.0
	33.7	9.3	18.5		73.2	3	3.0
XA(T)40/13B	15.5	4.3	18.5	2900	61.0	1.5	1.8
	25.9	7.2	17.0		73.0	2.2	2.0
	31.1	8.6	15.3		73.0	2.2	3.0
XA(T)40/13C	14.2	4.0	15.5	2900	60.0	1.5	1.8
	23.7	6.6	13.7		72.0	1.5	2.0
	28.5	7.9	12.2		72.0	2.2	3.0
XA(T)40/13D	12.9	3.6	12.5	2900	58.0	1.1	1.8
	21.6	6.0	11.0		70.0	1.5	2.0
	25.9	7.2	9.5		69.0	1.5	3.0
XA(T)40/16	18.0	5.0	39.5	2900	57.0	5.5	1.5
	30.0	8.3	35.0		64.0	5.5	2.2
	36.0	10.0	31.5		61.5	7.5	3.3
XA(T)40/16A	17.1	4.7	34.8	2900	56.0	4	1.5
	28.4	7.9	30.5		63.2	5.5	2.2
	34.1	9.5	27.6		61.0	5.5	3.3
XA(T)40/16B	16.0	4.5	30.5	2900	55.0	4	1.5
	26.7	7.4	26.5		61.2	4	2.2
	32.1	8.9	23.4		59.0	4	3.3
XA(T)40/16C	15.0	4.2	26.7	2900	53.0	3	1.5
	25.0	6.9	22.5		58.5	4	2.2
	30.0	8.3	19.5		56.0	4	3.3
XA(T)40/16D	14.0	3.9	23.1	2900	50.0	3	1.5
	23.3	6.5	19.5		57.0	3	2.2
	27.9	7.8	16.5		55.0	3	3.3
XA(T)40/16E	12.9	3.6	19.5	2900	48.0	3	1.5
	21.5	6.0	16.0		55.0	3	2.2
	25.9	7.2	13.5		51.0	3	3.3

Technical Parameter

Model	Capacity		Head (m)	Speed (r/min)	Eff. (%)	Motor power (kW)	NPSHr (mm)
	m³/h	L/s					
XA(T)40/20	18.0	5.0	61.5	2900	48.0	7.5	1.8
	30.0	8.3	56.5		58.0	11	2.0
	36.0	10.0	53.0		58.5	11	2.7
XA(T)40/20A	17.2	4.8	55.4	2900	48.0	7.5	1.8
	28.7	8.0	51.0		57.5	11	2.0
	34.5	9.6	47.3		58.0	11	2.7
XA(T)40/20B	16.4	4.6	49.5	2900	47.0	5.5	1.8
	27.3	7.6	47.5		56.5	7.5	2.0
	32.8	9.1	42.0		57.0	11	2.7
XA(T)40/20C	15.6	4.3	44.6	2900	46.0	7.5	1.8
	25.9	7.2	40.5		55.5	7.5	2.0
	31.1	8.6	36.5		55.0	7.5	2.7
XA(T)40/20D	14.7	4.1	39.9	2900	45.0	5.5	1.8
	24.5	6.8	36.0		54.0	7.5	2.0
	29.4	8.2	32.2		53.5	7.5	2.7
XA(T)40/20E	13.9	3.9	35.4	2900	44.5	5.5	1.8
	23.1	6.4	31.5		52.0	5.5	2.0
	27.7	7.7	28.2		51.5	5.5	2.7
XA(T)40/26	21.6	6.0	93.0	2900	40.0	15	1.8
	36.0	10.0	86.5		51.0	18.5	2.0
	43.2	12.0	81.5		53.0	22	2.5
XA(T)40/26A	20.9	5.8	86.0	2900	40.0	15	1.8
	34.8	9.7	80.0		50.3	18.5	2.0
	41.7	11.6	74.5		52.3	18.5	2.5
XA(T)40/26B	20.0	5.6	78.3	2900	39.0	15	1.8
	33.4	9.3	72.0		50.0	15	2.0
	40.1	11.1	66.0		51.0	18.5	2.5
XA(T)40/26C	19.2	5.3	71.0	2900	38.0	15	1.8
	32.0	8.9	66.2		48.5	15	2.0
	38.5	10.7	60.7		50.0	15	2.5
XA(T)40/26D	18.4	5.1	65.1	2900	38.0	11	1.8
	30.7	8.5	60.2		48.0	15	2.0
	36.8	10.2	55.7		48.5	15	2.5
XA(T)40/26E	17.6	4.9	59.4	2900	37.5	11	1.8
	29.3	8.1	54.3		47.0	11	2.0
	35.2	9.8	50.8		47.5	15	2.5
XA(T)40/26F	16.8	4.7	54.0	2900	37.5	11	1.8
	28.0	7.8	49.5		46.0	11	2.0
	33.5	9.3	45.5		46.5	11	2.5
XA(T)40/32	21.6	6.0	155.0	2900	33.5	30	2.7
	36.0	10.0	148.0		42.5	37	3.2
	43.2	12.0	140.0		44.0	45	4.8
XA(T)40/32A	20.7	5.7	139.0	2900	32.0	30	2.7
	34.5	9.6	133.0		41.5	37	3.2
	41.4	11.5	126.0		43.2	37	4.8
XA(T)40/32B	19.7	5.5	124.5	2900	31.0	30	2.7
	32.8	9.1	118.0		40.5	30	3.2
	39.4	10.9	114.0		42.0	37	4.8
XA(T)40/32C	18.7	5.2	111.0	2900	30.0	22	2.7
	31.2	8.7	107.0		39.5	30	3.2
	37.4	10.4	100.0		40.0	30	4.8
XA(T)40/32D	17.7	4.9	99.0	2900	28.0	22	2.7

Technical Parameter

Model	Capacity		Head (m)	Speed (r/min)	Eff. (%)	Motor power (kW)	NPSHr (mm)
	m³/h	L/s					
XA(T)50/26	36.2	10.1	84.0	2900	50.0	18.5	1.7
	60.3	16.8	78.0		60.0	30	2.5
	72.4	20.1	73.0		61.0	30	3.2
XA(T)50/26A	34.7	9.6	77.5	2900	49.5	18.5	1.7
	57.8	16.1	71.0		59.0	22	2.5
	69.4	19.3	66.0		60.0	30	3.2
XA(T)50/26B	33.2	9.2	71.0	2900	49.0	15	1.7
	55.4	15.4	65.0		57.5	22	2.5
	66.5	18.5	60.5		59.0	22	3.2
XA(T)50/26C	31.8	8.8	65.0	2900	48.0	15	1.7
	52.9	14.7	59.4		56.5	18.5	2.5
	63.5	17.6	55.2		57.5	18.5	3.2
XA(T)50/26D	30.3	8.4	59.0	2900	47.0	15	1.7
	50.5	14.0	53.5		55.0	18.5	2.5
	60.5	16.8	49.8		56.0	18.5	3.2
XA(T)50/32	54.0	15.0	151.5	2900	53.5	45	2.8
	90.0	25.0	136.0		61.0	55	4.5
	108.0	30.0	124.0		58.0	75	7.0
XA(T)50/32A	51.7	14.4	139.0	2900	52.5	45	2.8
	86.2	23.9	125.0		60.2	55	4.5
	103.4	28.7	113.5		58.5	75	7.0
XA(T)50/32B	49.2	13.7	126.0	2900	51.5	37	2.8
	82.1	22.8	113.0		59.0	45	4.5
	98.5	27.4	102.5		57.5	55	7.0
XA(T)50/32C	46.8	13.0	114.0	2900	50.5	30	2.8
	78.0	21.7	101.0		58.0	37	4.5
	93.6	26.0	92.0		56.5	45	7.0
XA(T)50/32D	44.3	12.3	101.5	2900	49.0	30	2.8
	73.9	20.5	90.5		56.5	37	4.5
	88.6	24.6	82.0		56.0	45	7.0
XA(T)50/32E	41.9	11.6	90.5	2900	48.5	22	2.8
	69.8	19.4	80.0		55.0	30	4.5
	83.7	23.3	72.5		54.5	37	7.0
XA(T)65/13	60.0	16.7	24.5	2900	68.0	7.5	3.0
	100.0	27.8	20.5		79.0	11	3.8
	120.0	33.3	17.2		76.0	11	4.2
XA(T)65/13A	56.1	15.6	20.6	2900	68.0	7.5	3.0
	93.5	26.0	16.2		76.6	7.5	3.8
	112.2	31.2	13.0		71.0	7.5	4.2
XA(T)65/13B	51.8	14.4	17.2	2900	66.0	5.5	3.0
	86.3	24.0	13.2		73.0	5.5	3.8
	103.6	28.8	10.2		67.0	5.5	4.2

Model	Capacity		Head (m)	Speed (r/min)	Eff. (%)	Motor power (kW)	NPSHr (mm)
	m³/h	L/s					
XA(T)65/16	60.0	16.7	39.7	2900	66.0	15	2.7
	100.0	27.8	34.0		75.0	15	3.5
	120.0	33.3	29.6		73.5	15	4.1
XA(T)65/16A	56.9	15.8	36.0	2900	67.0	11	2.7
	94.8	26.3	30.0		74.0	15	3.5
	113.8	31.6	25.8		72.5	15	4.1
XA(T)65/16B	53.5	14.8	32.0	2900	65.0	11	2.7
	89.1	24.7	26.2		72.6	11	3.5
	106.9	29.7	21.8		70.0	11	4.1
XA(T)65/16C	50.0	13.9	28.0	2900	63.0	7.5	2.7
	83.3	23.2	22.2		71.0	11	3.5
	100.0	27.8	18.2		68.5	11	4.1
XA(T)65/16D	46.6	12.9	24.2	2900	61.0	7.5	2.7
	77.6	21.6	19.2		69.0	7.5	3.5
	93.1	25.9	15.5		65.0	7.5	4.1
XA(T)65/16E	43.1	12.0	20.7	2900	60.0	5.5	2.7
	71.8	20.0	16.0		67.0	5.5	3.5
	86.2	23.9	12.8		63.0	5.5	4.1
XA(T)65/20	66.0	18.3	64.2	2900	59.0	22	2.4
	110.0	30.6	56.5		73.3	30	3.7
	132.0	36.7	52.0		73.2	30	5.2
XA(T)65/20A	63.2	17.6	58.2	2900	62.0	18.5	2.4
	105.4	29.3	50.5		73.0	30	3.7
	126.4	35.1	45.6		72.5	30	5.2
XA(T)65/20B	60.1	16.7	52.9	2900	60.0	18.5	2.4
	100.2	27.8	46.0		72.5	22	3.7
	120.3	33.4	41.4		72.0	22	5.2
XA(T)65/20C	57.0	15.8	47.6	2900	60.0	15	2.4
	95.1	26.4	41.4		72.0	22	3.7
	114.1	31.7	37.3		71.5	22	5.2
XA(T)65/20D	54.0	15.0	42.0	2900	59.0	15	2.4
	89.9	25.0	36.6		71.0	18.5	3.7
	107.9	30.0	32.7		70.5	18.5	5.2
XA(T)65/20E	50.9	14.1	36.8	2900	57.0	11	2.4
	84.8	23.6	32.0		70.0	15	3.7
	101.8	28.3	28.0		68.0	15	5.2
XA(T)65/26	72.0	20.0	98.0	2900	63.0	37	2.4
	120.0	33.3	89.9		73.5	45	4.2
	144.0	40.0	82.3		71.5	55	5.8
XA(T)65/26A	69.5	19.3	91.0	2900	62.0	37	2.4
	115.9	32.2	83.0		73.0	45	4.2
	139.1	38.6	76.0		71.0	45	5.8
XA(T)65/26B	66.8	18.6	84.5	2900	61.0	30	2.4
	111.4	30.9	77.0		72.5	37	4.2
	133.6	37.1	70.0		71.0	45	5.8
XA(T)65/26C	64.1	17.8	78.5	2900	59.0	30	2.4
	106.8	29.7	71.0		71.5	37	4.2
	128.2	35.6	64.0		70.5	37	5.8
XA(T)65/26D	61.4	17.0	72.5	2900	58.0	30	2.4
	102.3	28.4	65.0		70.6	30	4.2
	122.7	34.1	59.0		70.0	37	5.8
XA(T)65/26E	58.6	16.3	66.2	2900	57.5	22	2.4
	97.7	27.1	59.4		68.5	30	4.2
	117.3	32.6	50.8		65.0	30	5.8
XA(T)65/26F	55.9	15.5	59.0	2900	55.0	22	2.4
	93.2	25.9	52.6		65.5	30	4.2
	111.8	31.1	48.0		65.0	30	5.8

Technical Parameter

Model	Capacity		Head (m)	Speed (r/min)	Eff. (%)	Motor power (kW)	NPSHr (mm)
	m³/h	L/s					
XA(T)65/32	78.0	21.7	143.5	2900	54.0	75	3.1
	130.0	36.1	133.5		63.7	90	4.8
	156.0	43.3	124.0		64.0	90	6.8
XA(T)65/32A	74.7	20.7	131.0	2900	53.5	55	3.1
	124.4	34.6	119.0		63.3	75	4.8
	149.3	41.5	110.0		63.3	90	6.8
XA(T)65/32B	71.1	19.8	117.0	2900	51.5	55	3.1
	118.5	32.9	105.0		62.5	75	4.8
	142.2	39.5	95.3		62.0	75	6.8
XA(T)65/32C	67.5	18.8	104.0	2900	51.0	45	3.1
	112.6	31.3	92.0		61.0	55	4.8
	135.1	37.5	82.6		60.0	75	6.8
XA(T)65/32D	64.0	17.8	94.2	2900	50.0	45	3.1
	106.7	29.6	82.0		60.0	55	4.8
	128.0	35.6	71.7		57.5	55	6.8
XA(T)65/32E	60.4	16.8	83.0	2900	49.0	37	3.1
	100.7	28.0	72.3		55.5	37	4.8
	120.9	33.6	62.2		54.5	45	6.8
XA(T)80/16	97.2	27.0	40.3	2900	70.0	18.5	2.7
	162.0	45.0	34.7		80.0	22	3.8
	194.4	54.0	29.3		74.0	30	5.0
XA(T)80/16A	92.2	25.6	34.8	2900	67.5	18.5	2.7
	153.6	42.7	29.1		76.0	18.5	3.8
	184.3	51.2	24.2		69.0	22	5.0
XA(T)80/16B	86.6	24.1	30.7	2900	63.0	15	2.7
	144.3	40.1	24.7		74.0	15	3.8
	173.2	48.1	20.1		66.0	18.5	5.0
XA(T)80/16C	81.0	22.5	26.9	2900	62.0	11	2.7
	135.0	37.5	21.6		72.0	15	3.8
	162.0	45.0	17.4		64.0	15	5.0
XA(T)80/16D	75.4	20.9	22.8	2900	58.0	11	2.7
	125.7	34.9	18.2		66.0	11	3.8
	150.8	41.9	14.4		60.0	11	5.0
XA(T)80/20	114.0	31.7	60.5	2900	67.0	37	3.1
	190.0	52.8	52.7		77.8	45	4.8
	228.0	63.3	46.0		73.5	45	5.8
XA(T)80/20A	109.2	30.3	55.1	2900	65.0	30	4.0
	182.0	50.6	47.9		77.1	37	4.9
	218.4	60.7	41.5		72.5	37	5.9
XA(T)80/20B	103.9	28.9	49.6	2900	62.0	30	4.0
	173.1	48.1	43.6		76.0	30	4.7
	207.8	57.7	37.6		72.0	37	5.5
XA(T)80/20C	98.6	27.4	43.8	2900	62.0	30	4.0
	164.3	45.6	37.2		74.0	30	4.7
	197.1	54.8	31.8		69.0	30	5.5
XA(T)80/20D	93.2	25.9	39.2	2900	66.0	18.5	4.0
	155.4	43.2	33.3		76.0	22	4.7
	186.5	51.8	28.5		75.0	30	5.5
XA(T)80/20E	87.9	24.4	34.8	2900	65.5	15	4.0
	146.5	40.7	29.6		75.5	18.5	4.7
	175.8	48.8	25.3		74.5	22	6

Model	Capacity		Head (m)	Speed (r/min)	Eff. (%)	Motor power (kW)	NPSHr (mm)
	m³/h	L/s					
XA(T)80/26	114.0	31.7	95.0	2900	65.5	55	3
	190.0	52.8	83.5		75.0	75	4</

Technical Parameter

Model	Capacity		Head (m)	Speed (r/min)	Eff. (%)	Motor power (kW)	NPSHr (mm)
	m³/h	L/s					
XA(T)100/20	171.0	47.5	58.7	2900	70.0	45	3.9
	285.0	79.2	50.1		80.0	55	5.8
	342.0	95.0	42.0		74.5	75	6.9
XA(T)100/20A	163.8	45.5	53.2	2900	69.0	45	3.9
	273.0	75.8	44.3		79.0	55	5.8
	327.6	91.0	37.0		73.5	55	6.9
XA(T)100/20B	155.8	43.3	47.0	2900	68.0	37	3.9
	259.7	72.1	38.7		77.0	45	5.8
	311.6	86.6	31.5		70.5	45	6.9
XA(T)100/20C	147.8	41.1	42.0	2900	66.0	30	3.9
	246.4	68.4	33.0		73.5	37	5.8
	295.7	82.1	26.3		67.5	37	6.9
XA(T)100/20D	139.8	38.8	37.2	2900	63.0	30	3.9
	233.1	64.7	28.7		70.0	30	5.8
	279.7	77.7	21.8		64.0	30	6.9
XA(T)100/20E	131.9	36.6	32.0	2900	59.5	30	3.9
	219.8	61.0	24.0		67.5	30	5.8
	263.7	73.3	18.0		60.0	30	6.9
XA100/26	177.0	49.2	95.0	2900	65.0	90	3.9
	295.0	81.9	85.0		78.0	110	5.8
	354.0	98.3	75.0		75.5	110	7.0
XA100/26A	171.0	47.5	88.0	2900	65.0	75	3.9
	284.9	79.1	78.2		77.2	90	5.8
	341.9	95.0	69.0		75.0	110	7.0
XA100/26B	164.3	45.6	81.5	2900	64.0	75	3.9
	273.8	76.0	71.5		75.6	90	5.8
	328.5	91.3	63.0		74.0	90	7.0
XA100/26C	157.5	43.8	75.0	2900	63.0	75	3.9
	262.6	72.9	65.2		74.5	75	5.8
	315.1	87.5	56.8		72.5	75	7.0
XA100/26D	150.8	41.9	68.7	2900	62.0	55	3.9
	251.4	69.8	58.5		72.5	75	5.8
	301.7	83.8	50.5		70.0	75	7.0
XA100/26E	144.1	40.0	62.3	2900	61.5	55	3.9
	240.2	66.7	52.4		70.5	75	5.8
	288.3	80.1	44.5		68.0	75	7.0
XA100/26F	137.4	38.2	56.0	2900	58.0	45	3.9
	229.1	63.6	46.4		69.0	55	5.8
	274.9	76.4	38.0		63.0	55	7.0
XA(T)125/20	216.0	60.0	56.5	2900	59.5	75	4.7
	360.0	100.0	49.0		74.0	90	6.5
	432.0	120.0	42.5		72.5	90	7.2
XA(T)125/20A	206.9	57.5	51.7	2900	58.0	55	4.7
	344.9	95.8	43.6		72.5	75	6.5
	413.8	115.0	37.0		71.3	75	7.2
XA(T)125/20B	196.8	54.7	46.3	2900	57.0	55	4.7
	328.0	91.1	37.8		71.5	55	6.5
	393.6	109.3	31.5		69.0	55	7.2
XA(T)125/20C	186.7	51.9	40.6	2900	54.0	45	4.7
	311.2	86.4	32.3		70.0	45	6.5
	373.5	103.7	26.2		66.0	45	7.2

Model	Capacity		Head (m)	Speed (r/min)	Eff. (%)	Motor power (kW)	NPSHr (mm)
	m³/h	L/s					
XA(T)32/13	4.3	1.2	6.7	1450	47.0	0.55	1.7
	7.2	2.0	6.2		58.0	0.55	2.0
	8.7	2.4	5.8		59.0	0.55	2.1
XA(T)32/13A	4.1	1.1	5.7	1450	46.0	0.55	1.7
	6.8	1.9	5.2		56.5	0.55	2.0
	8.1	2.3	4.8		58.0	0.55	2.1
XA(T)32/13B	3.7	1.0	4.7	1450	45.0	0.55	1.7
	6.2	1.7	4.2		55.0	0.55	2.0
	7.5	2.1	3.9		56.0	0.55	2.1
XA(T)32/13C	3.4	1.0	3.9	1450	45.0	0.55	1.7
	5.7	1.6	3.5		54.0	0.55	2.0
	6.9	1.9	3.1		54.0	0.55	2.1
XA(T)32/13D	3.1	0.9	3.1	1450	44.0	0.55	1.7
	5.2	1.4	2.7		51.0	0.55	2.0
	6.2	1.7	2.3		52.0	0.55	2.1
XA(T)32/16	5.2	1.4	10.6	1450	47.5	0.55	1.8
	8.7	2.4	10.1		55.0	0.55	2.0
	10.4	2.9	9.5		56.0	0.75	2.2
XA(T)32/16A	4.9	1.4	9.5	1450	45.0	0.55	1.8
	8.2	2.3	9.0		55.0	0.55	2.0
	9.9	2.7	8.5		55.5	0.55	2.2
XA(T)32/16B	4.6	1.3	8.4	1450	44.0	0.55	1.8
	7.7	2.1	7.8		53.5	0.55	2.0
	9.3	2.6	7.3		54.0	0.55	2.2
XA(T)32/16C	4.3	1.2	7.4	1450	42.0	0.55	1.8
	7.2	2.0	6.8		51.5	0.55	2.0
	8.7	2.4	6.4		52.0	0.55	2.2
XA(T)32/16D	4.0	1.1	6.4	1450	41.5	0.55	1.8
	6.7	1.9	5.9		49.5	0.55	2.0
	8.1	2.2	5.5		50.0	0.55	2.2
XA(T)32/16E	3.7	1.0	5.5	1450	40.0	0.55	1.8
	6.2	1.7	5.1		47.0	0.55	2.0
	7.5	2.1	4.7		49.0	0.55	2.2
XA(T)32/20	5.2	1.4	16.0	1450	37.0	0.75	1.9
	8.7	2.4	14.7		46.5	1.1	2.0
	10.4	2.9	13.6		47.5	1.1	2.3
XA(T)32/20A	5.0	1.4	14.6	1450	36.0	0.75	1.9
	8.3	2.3	13.2		46.0	1.1	2.0
	10.0	2.8	12.1		46.5	1.1	2.3
XA(T)32/20B	4.7	1.3	13.2	1450	34.5	0.75	1.9
	7.9	2.2	11.9		45.0	0.75	2.0
	9.5	2.6	10.9		45.0	0.75	2.3
XA(T)32/20C	4.5	1.3	11.9	1450	34.0	0.75	1.9
	7.5	2.1	10.8		40.0	0.75	2.0
	9.0	2.5	9.9		44.5	0.75	2.3
XA(T)32/20D	4.3	1.2	10.6	1450	33.5	0.55	1.9
	7.1	2.0	9.6		42.0	0.55	2.0
	8.5	2.4	8.8		42.0	0.55	2.3
XA(T)32/20E	4.0	1.1	9.5	1450	33.0	0.55	1.9
	6.7	1.9	8.6		40.0	0.55	2.0
	8.0	2.2	7.8		40.0	0.55	2.3

Technical Parameter

Model	Capacity		Head (m)	Speed (r/min)	Eff. (%)	Motor power (kW)	NPSHr (mm)
	m³/h	L/s					
XA(T)32/26	6.6	1.8	23.7	1450	30.0	2.2	1.8
	11.0	3.1	22.4		38.0	2.2	2.1
	13.2	3.7	21.4		40.0	3	2.4
	6.4	1.8	21.8		30.0	2.2	1.8
XA(T)32/26A	10.6	2.9	20.9	1450	37.0	2.2	2.1
	12.7	3.5	19.9		39.5	2.2	2.4
	6.1	1.7	20.2		29.0	2.2	1.8
	10.2	2.8	19.3		37.0	2.2	2.1
XA(T)32/26B	12.2	3.4	18.5	1450	39.0	2.2	2.4
	5.9	1.6	18.6		28.5	2.2	1.8
	9.8	2.7	17.8		36.0	2.2	2.1
XA(T)32/26C	11.7	3.3	17.0	1450	38.0	2.2	2.4
	5.6	1.6	17.1		28.0	1.5	1.8
	9.4	2.6	16.3		35.0	1.5	2.1
XA(T)32/26D	11.2	3.1	15.7	1450	37.0	1.5	2.4
	5.4	1.5	15.9		27.5	1.5	1.8
	8.9	2.5	15.1		34.0	1.5	2.1
XA(T)32/26E	10.7	3.0	14.5	1450	36.0	1.5	2.4
	5.1	1.4	14.8		26.5	1.5	1.8
	8.5	2.4	14.0		33.0	1.5	2.1
XA(T)32/26F	10.2	2.8	13.3	1450	35.0	1.5	2.4
	8.7	2.4	6.4		59.0	0.55	1.8
	14.5	4.0	6.0		71.0	0.55	2.0
XA(T)40/13	17.4	4.8	5.6	1450	72.0	0.55	2.4
	8.1	2.3	5.6		58.0	0.55	1.8
	13.6	3.8	5.2		71.0	0.55	2.0
XA(T)40/13A	16.3	4.5	4.8	1450	71.0	0.55	2.4
	7.5	2.1	4.8		56.0	0.55	1.8
	12.5	3.5	4.3		69.0	0.55	2.0
XA(T)40/13B	15.0	4.2	3.9	1450	68.5	0.55	2.4
	6.9	1.9	4.0		51.0	0.55	1.8
	11.5	3.2	3.6		64.0	0.55	2.0
XA(T)40/13C	13.8	3.8	3.3	1450	63.5	0.55	2.4
	6.3	1.7	3.3		50.5	0.55	1.8
	10.4	2.9	3.0		58.0	0.55	2.0
XA(T)40/13D	12.5	3.5	2.6	1450	58.0	0.55	2.4
	8.7	2.4	10.0		59.0	0.55	1.8
	14.5	4.0	9.0		63.0	0.75	2.0
XA(T)40/16	17.4	4.8	8.1	1450	61.5	1.1	2.4
	8.3	2.3	8.9		57.0	0.55	1.8
	13.8	3.8	8.0		62.0	0.75	2.0
XA(T)40/16A	16.5	4.6	7.2	1450	60.0	0.75	2.4
	7.8	2.2	7.8		56.0	0.55	1.8
	12.9	3.6	7.0		60.0	0.55	2.0
XA(T)40/16B	15.5	4.3	6.3	1450	58.0	0.75	2.4
	7.3	2.0	7.0		50.0	0.55	1.8
	12.1	3.4	6.0		57.0	0.55	2.0
XA(T)40/16C	14.5	4.0	5.4	1450	55.0	0.55	2.4
	6.8	1.9	6.0		48.5	0.55	1.8
	11.3	3.1	5.2		53.0	0.55	2.0
XA(T)40/16D	13.5	3.8	4.4	1450	50.0	0.55	2.4
	6.3	1.7	5.1		43.0	0.55	1.8
	10.4	2.9	4.3		49.0	0.55	2.0
XA(T)40/16E	12.5	3.5	3.6	1450	45.0	0.55	2.4

Model	Capacity		Head (m)	Speed (r/min)	Eff. (%)	Motor power (kW)	NPSHr (mm)
	m³/h	L/s					
XA(T)40/20	8.7	2.4	15.5	1450	48.0	1.1	1.8
	14.5	4.0	14.3		57.0	1.5	2.2
	17.4	4.8	13.2		57.5	1.5	2.5
XA(T)40/20A	8.3	2.3	14.0	1450	48.0	1.1	1.8
	13.9	3.9	13.0		56.0	1.1	2.2
	16.7	4.6	12.0		57.0	1.5	2.5
XA(T)40/20B	7.9	2.2	12.7	1450	46.0	1.1	1.8
	13.2	3.7	11.6		55.0	1.1	2.2
	15.9	4.4	10.8		55.5	1.1	2.5
XA(T)40/20C	7.5	2.1	11.2	1450	45.5	0.75	1.8
	12.5	3.5	10.4		54.0	1.1	2.2
	15.1	4.2	9.6		54.5	1.1	2.5
XA(T)40/20D	7.1	2.0	10.0	1450	44.0	0.75	1.8
	11.9	3.3	9.2		53.0	0.75	2.2
	14.2	4.0	8.4		53.5	0.75	2.5
XA(T)40/20E	6.7	1.9	9.0	1450	43.5	0.55	1.8
	11.2	3.1	8.0		50.5	0.75	2.2
	13.4	3.7	7.3		51.0	0.75	2.5
XA(T							

Technical Parameter

Model	Capacity		Head (m)	Speed (r/min)	Eff. (%)	Motor power (kW)	NPSHr (mm)
	m³/h	L/s					
XA(T)50/13	17.4	4.8	6.8	1450	59.0	0.75	2.2
	28.9	8.0	6.3		72.0	1.1	2.4
	34.7	9.6	5.8		73.0	1.1	2.7
XA(T)50/13A	16.2	4.5	5.8	1450	58.5	0.75	2.2
	27.1	7.5	5.2		72.0	0.75	2.4
	32.5	9.0	4.7		72.0	0.75	2.7
XA(T)50/13B	15.0	4.2	4.9	1450	62.0	0.55	2.2
	25.0	6.9	4.4		71.0	0.55	2.4
	30.0	8.3	3.8		69.0	0.55	2.7
XA(T)50/13C	13.7	3.8	4.1	1450	61.0	0.55	2.2
	22.9	6.4	3.4		67.0	0.55	2.4
	27.5	7.6	2.8		64.0	0.55	2.7
XA(T)50/16	18.5	5.1	10.5	1450	65.0	1.1	2.1
	30.9	8.6	9.5		74.0	1.5	2.2
	37.1	10.3	8.8		70.0	1.5	2.4
XA(T)50/16A	17.6	4.9	9.4	1450	64.0	1.1	2.1
	29.3	8.1	8.5		73.0	1.5	2.2
	35.1	9.8	7.8		73.0	1.5	2.4
XA(T)50/16B	16.5	4.6	8.3	1450	61.0	1.1	2.1
	27.5	7.6	7.5		72.0	1.1	2.2
	33.0	9.2	6.9		72.0	1.1	2.4
XA(T)50/16C	15.4	4.3	7.3	1450	59.0	0.75	2.1
	25.7	7.2	6.6		70.0	1.1	2.2
	30.9	8.6	6.0		71.5	1.1	2.4
XA(T)50/16D	14.4	4.0	6.3	1450	57.5	0.55	2.1
	24.0	6.7	5.7		67.5	0.75	2.2
	28.8	8.0	5.0		67.0	0.75	2.4
XA(T)50/16E	13.3	3.7	5.4	1450	56.0	0.55	2.1
	22.2	6.2	4.6		66.0	0.55	2.2
	26.6	7.4	4.0		65.0	0.55	2.4
XA(T)50/20	18.0	5.0	15.3	1450	59.0	2.2	1.3
	30.0	8.3	13.3		65.0	2.2	1.5
	36.0	10.0	11.8		62.0	2.2	1.8
XA(T)50/20A	17.2	4.8	14.0	1450	57.5	1.5	1.3
	28.7	8.0	12.0		64.5	2.2	1.5
	34.5	9.6	10.6		61.0	2.2	1.8
XA(T)50/20B	16.4	4.6	12.5	1450	54.5	1.5	1.3
	27.3	7.6	10.7		63.0	2.2	1.5
	32.8	9.1	9.4		60.0	2.2	1.8
XA(T)50/20C	15.6	4.3	11.1	1450	52.0	1.1	1.3
	25.9	7.2	9.6		61.5	1.5	1.5
	31.1	8.6	8.2		58.5	1.5	1.8
XA(T)50/20D	14.7	4.1	9.8	1450	51.5	1.1	1.3
	24.5	6.8	8.3		58.5	1.5	1.5
	29.4	8.2	7.2		55.0	1.5	1.8
XA(T)50/20E	13.9	3.9	8.6	1450	49.0	1.1	1.3
	23.1	6.4	7.1		55.0	1.1	1.5
	27.7	7.7	5.9		52.0	1.1	1.8

Model	Capacity		Head (m)	Speed (r/min)	Eff. (%)	Motor power (kW)	NPSHr (mm)
	m³/h	L/s					
XA(T)50/26	19.2	5.3	25.0	1450	53.0	3	1.7
	32.0	8.9	23.5		63.0	4	1.8
	38.4	10.7	22.3		64.0	6	1.9
XA(T)50/26A	18.5	5.2	23.1	1450	51.5	3	1.7
	30.9	8.6	21.7		62.0	4	1.8
	37.1	10.3	20.6		63.0	5.5	1.9
XA(T)50/26B	17.8	5.0	21.4	1450	51.5	3	1.7
	29.7	8.3	20.0		62.0	4	1.8
	35.6	9.9	19.1		63.5	4	1.9
XA(T)50/26C	17.1	4.7	19.8	1450	51.0	3	1.7
	28.5	7.9	18.6		61.0	3	1.8
	34.2	9.5	17.7		63.0	4	1.9
XA(T)50/26D	16.4	4.5	18.2	1450	50.0	2.2	1.7
	27.3	7.6	17.0		60.0	3	1.8
	32.7	9.1	16.1		61.5	3	1.9
XA(T)50/26E	15.6	4.3	16.6	1450	49.5	2.2	1.7
	26.1	7.2	15.5		59.5	3	1.8
	31.3	8.7	14.7		61.0	3	1.9
XA(T)50/26F	14.9	4.1	15.1	1450	49.0	1.5	1.7
	24.9	6.9	14.0		58.5	2.2	1.8
	29.8	8.3	13.2		60.0	2.2	1.9
XA(T)50/32	30.2	8.4	35.6	1450	52.0	7.5	1.5
	50.4	14.0	31.1		58.0	11	2.2
	60.5	16.8	27.8		55.0	11	2.7
XA(T)50/32A	29.0	8.0	32.5	1450	52.0	7.5	1.5
	48.3	13.4	27.3		57.5	7.5	2.2
	57.9	16.1	24.9		55.0	11	2.7
XA(T)50/32B	27.6	7.7	29.4	1450	52.0	5.5	1.5
	46.0	12.8	25.1		57.0	7.5	2.2
	55.1	15.3	22.4		54.0	7.5	2.7
XA(T)50/32C	26.2	7.3	26.1	1450	52.0	5.5	1.5
	43.7	12.1	22.4		56.0	7.5	2.2
	52.4	14.6	19.6		53.5	7.5	2.7
XA(T)50/32D	24.8	6.9	23.0	1450	52.0	4	1.5
	41.4	11.5	19.8		56.0	5.5	2.2
	49.6	13.8	17.2		52.0	5.5	2.7
XA(T)50/32E	23.4	6.5	20.2	1450	52.0	4	1.5
	39.1	10.9	19.8		55.0	4	2.2
	46.9	13.0	14.9		52.0	4	2.7
XA(T)65/13	29.0	8.0	6.4	1450	65.0	1.1	2.3
	48.3	13.4	5.5		78.0	1.5	2.4
	57.9	16.1	4.8		77.0	1.5	2.7
XA(T)65/13A	27.1	7.5	5.5	1450	68.0	1	2.3
	45.2	12.5	4.6		78.0	1.1	2.4
	54.2	15.1	3.6		75.0	1.1	2.7
XA(T)65/13B	25.0	6.9	4.6	1450	67.5	1	2.3
	41.7	11.6	3.8		77.5	1	2.4
	50.0	13.9	3.0		74.0	1	2.7

Technical Parameter

Model	Capacity		Head (m)	Speed (r/min)	Eff. (%)	Motor power (kW)	NPSHr (mm)
	m³/h	L/s					
XA(T)65/16	30.0	8.3	10.2	1450	66.0	2.2	2.0
	50.0	13.9	8.8		78.0	2.2	2.3
	60.0	16.7	7.8		77.0	2.2	2.6
XA(T)65/16A	28.5	7.9	9.2	1450	65.5	1.5	2.0
	47.4	13.2	7.5		77.0	2.2	2.3
	56.9	15.8	6.7		75.0	2.2	2.6
XA(T)65/16B	26.7	7.4	8.1	1450	65.0	1.1	2.0
	44.5	12.4	7.1		75.5	1.1	2.3
	53.5	14.8	5.9		74.0	1.5	2.6
XA(T)65/16C	25.0	6.9	7.1	1450	64.0	1.1	2.0
	41.7	11.6	6.0		74.0	1.5	2.3
	50.0	13.9	5.2		72.0	1.5	2.6
XA(T)65/16D	23.3	6.5	6.1	1450	61.0	1.1	2.0
	38.8	10.8	5.2		72.0	1.1	2.3
	46.6	12.9	4.5		70.0	1.1	2.6
XA(T)65/16E	21.6	6.0	5.5	1450	60.0	1	2.0
	35.9	10.0	4.5		69.0	1.1	2.3
	43.1	12.0	3.8		67.0	1.1	2.6
XA(T)65/20	33.0	9.2	15.6	1450	65.0	3	1.7
	55.0	15.3	13.7		72.5	4	1.9
	66.0	18.3	11.4		71.0	4	2.1
XA(T)65/20A	31.6	8.8	14.1	1450	64.0	3	1.7
	52.7	14.6	12.4		72.5	3	1.9
	63.2	17.6	11.1		72.0	3	2.1
XA(T)65/20B	30.1	8.3	12.8	1450	62.0	2.2	1.7
	50.1	13.9	11.2		72.0	3	1.9
	60.1	16.7	10.0		72.0	3	2.1
XA(T)65/20C	28.5	7.9	11.4	1450	60.0	2.2	1.7
	47.5	13.2	10.0		71.5	2.2	1.9
	57.0	15.8	9.0		71.0	2.2	2.1
XA(T)65/20D	27.0	7.5	10.2	1450	56.0	2.2	1.7
	45.0	12.5	8.9		69.5	2.2	1.9
	53.9	15.0	7.8		69.0	2.2	2.1
XA(T)65/20E	25.4	7.1	9.0	1450	55.0	1.5	1.7
	42.4	11.8	7.7		68.0	2.2	1.9
	50.9	14.1	6.8		66.0	2.2	2.1
XA(T)65/26	36.0	10.0	24.6	1450	59.0	5.5	1.7
	60.0	16.7	23.0		72.0	7.5	1.9
	72.0	20.0	21.7		73.0	7.5	2.0
XA(T)65/26A	34.8	9.7	22.7	1450	59.0	5.5	1.7
	58.0	16.1	21.5		72.0	7.5	1.9
	69.6	19.3	20.0		73.0	7.5	2.0
XA(T)65/26B	33.4	9.3	21.0	1450	58.0	4	1.7
	55.7	15.5	19.8		71.0	5.5	1.9
	66.8	18.6	18.3		72.5	5.5	2.0
XA(T)65/26C	32.1	8.9	19.6	1450	57.0	4	1.7
	53.4	14.8	18.2		70.0	5.5	1.9
	64.1	17.8	17.0		72.0	5.5	2.0
XA(T)65/26D	30.7	8.5	18.1	1450	56.0	4	1.7
	51.1	14.2	16.7		69.0	5.5	1.9
	61.4	17.0	15.3		69.0	5.5	2.0
XA(T)65/26E	29.3	8.1	16.4	1450	55.0	3	1.7
	48.9	13.6	15.1		67.0	4	1.9
	58.6	16.3	13.9		67.0	4	2.0
XA(T)65/26F	28.0	7.8	15.0	1450	53.0	3	1.7
	46.6	12.9	13.8		65.5	4	1.9
	55.9	15.5	12.5		65.0	4	2.0

Model	Capacity		Head (m)	Speed (r/min)	Eff. (%)	Motor power (kW)	NPSHr (mm)
	m³/h	L/s					
XA(T)65/32	39.0	10.8	37.0	1450	54.0	11	1.9
	65.0	18.1	34.0		64.0	11	2.0
	78.0	21.7	31.7		65.		

Technical Parameter

Model	Capacity		Head (m)	Speed (r/min)	Eff. (%)	Motor power (kW)	NPSHr (mm)
	m³/h	L/s					
XA(T)80/26	30.0	8.3	10.2	1450	66.0	2.2	2.0
	50.0	13.9	8.8		78.0	2.2	2.3
	60.0	16.7	7.8		77.0	2.2	2.6
XA(T)80/26A	28.5	7.9	9.2	1450	65.5	1.5	2.0
	47.4	13.2	7.5		77.0	2.2	2.3
	56.9	15.8	6.7		75.0	2.2	2.6
XA(T)80/26B	26.7	7.4	8.1	1450	65.0	1.1	2.0
	44.5	12.4	7.1		75.5	1.1	2.3
	53.5	14.8	5.9		74.0	1.5	2.6
XA(T)80/26C	25.0	6.9	7.1	1450	64.0	1.1	2.0
	41.7	11.6	6.0		74.0	1.5	2.3
	50.0	13.9	5.2		72.0	1.5	2.6
XA(T)80/26D	23.3	6.5	6.1	1450	61.0	1.1	2.0
	38.8	10.8	5.2		72.0	1.1	2.3
	46.6	12.9	4.5		70.0	1.1	2.6
XA(T)80/26E	21.6	6.0	5.5	1450	60.0	1	2.0
	35.9	10.0	4.5		69.0	1.1	2.3
	43.1	12.0	3.8		67.0	1.1	2.6
XA(T)80/26F	33.0	9.2	15.6	1450	65.0	3	1.7
	55.0	15.3	13.7		72.5	4	1.9
	66.0	18.3	11.4		71.0	4	2.1
XA(T)80/32	31.6	8.8	14.1	1450	64.0	3	1.7
	52.7	14.6	12.4		72.5	3	1.9
	63.2	17.6	11.1		72.0	3	2.1
XA(T)80/32A	30.1	8.3	12.8	1450	62.0	2.2	1.7
	50.1	13.9	11.2		72.0	3	1.9
	60.1	16.7	10.0		72.0	3	2.1
XA(T)80/32B	28.5	7.9	11.4	1450	60.0	2.2	1.7
	47.5	13.2	10.0		71.5	2.2	1.9
	57.0	15.8	9.0		71.0	2.2	2.1
XA(T)80/32C	27.0	7.5	10.2	1450	56.0	2.2	1.7
	45.0	12.5	8.9		69.5	2.2	1.9
	53.9	15.0	7.8		69.0	2.2	2.1
XA(T)80/32D	25.4	7.1	9.0	1450	55.0	1.5	1.7
	42.4	11.8	7.7		68.0	2.2	1.9
	50.9	14.1	6.8		66.0	2.2	2.1
XA(T)80/32E	36.0	10.0	24.6	1450	59.0	5.5	1.7
	60.0	16.7	23.0		72.0	7.5	1.9
	72.0	20.0	21.7		73.0	7.5	2.0
XA(T)80/40	34.8	9.7	22.7	1450	59.0	5.5	1.7
	58.0	16.1	21.5		72.0	7.5	1.9
	69.6	19.3	20.0		73.0	7.5	2.0
XA(T)80/40A	33.4	9.3	21.0	1450	58.0	4	1.7
	55.7	15.5	19.8		71.0	5.5	1.9
	66.8	18.6	18.3		72.5	5.5	2.0
XA(T)80/40B	32.1	8.9	19.6	1450	57.0	4	1.7
	53.4	14.8	18.2		70.0	5.5	1.9
	64.1	17.8	17.0		72.0	5.5	2.0
XA(T)80/40C	30.7	8.5	18.1	1450	56.0	4	1.7
	51.1	14.2	16.7		69.0	5.5	1.9
	61.4	17.0	15.3		69.0	5.5	2.0
XA(T)80/40D	29.3	8.1	16.4	1450	55.0	3	1.7
	48.9	13.6	15.1		67.0	4	1.9
	58.6	16.3	13.9		67.0	4	2.0
XA(T)80/40E	28.0	7.8	15.0	1450	53.0	3	1.7
	46.6	12.9	13.8		65.5	4	1.9
	55.9	15.5	12.5		65.0	4	2.0
XA(T)80/40F	28.0	7.8	15.0	1450	53.0	3	1.7
	46.6	12.9	13.8		65.5	4	1.9
	55.9	15.5	12.5		65.0	4	2.0

Model	Capacity		Head (m)	Speed (r/min)	Eff. (%)	Motor power (kW)	NPSHr (mm)
	m³/h	L/s					
XA(T)100/16	75.6	21.0	8.8	1450	67.0	4	2.0
	126.0	35.0	7.2		81.0	4	2.1
	151.2	42.0	5.8		76.2	4	2.7
XA(T)100/16A	70.9	19.7	7.8	1450	68.0	3	2.0
	118.1	32.8	6.2		79.5	3	2.1
	141.8	39.4	5.5		78.5	3	2.7
XA(T)100/16B	66.6	18.5	6.8	1450	67.0	3	2.0
	111.0	30.8	5.5		77.6	3	2.1
	133.2	37.0	4.5		75.5	3	2.7
XA(T)100/16C	62.3	17.3	6.0	1450	64.5	2.2	2.0
	103.8	28.8	4.8		76.0	2.2	2.1
	124.6	34.6	3.9		73.0	2.2	2.7
XA(T)100/20	85.2	23.7	14.9	1450	70.0	7.5	1.7
	142.0	39.4	13.0		80.0	7.5	1.9
	170.4	47.3	11.1		75.0	11	2.2
XA(T)100/20A	81.6	22.7	13.4	1450	70.0	5.5	1.7
	136.0	37.8	11.5		79.0	7.5	1.9
	163.2	45.3	9.8		75.5	7.5	2.2
XA(T)100/20B	77.6	21.6	12.1	1450	68.0	5.5	1.7
	129.4	35.9	10.0		77.0	5.5	1.9
	155.3	43.1	8.3		74.0	5.5	2.2
XA(T)100/20C	73.6	20.5	10.8	1450	67.0	4	1.7
	122.7	34.1	8.7		75.5	5.5	1.9
	147.3	40.9	7.1		71.0	5.5	2.2
XA(T)100/20D	69.7	19.4	9.5	1450	63.0	4	1.7
	116.1	32.3	7.3		73.5	4	1.9
	139.3	38.7	5.7		68.0	4	2.2
XA(T)100/20E	65.7	18.2	8.3	1450	60.0	3	1.7
	109.5	30.4	6.1		70.8	3	1.9
	131.4	36.5	4.5		62.0	3	2.2
XA(T)100/26	88.8	24.7	24.7	1450	67.0	11	1.8
	148.0	41.1	22.0		78.0	15	2.0
	177.6	49.3	19.6		75.0	15	2.3
XA(T)100/26A	85.8	23.8	22.8	1450	66.5	11	1.8
	143.0	39.7	20.4		76.5	15	2.0
	171.5	47.7	18.0		73.5	15	2.3
XA(T)100/26B	82.4	22.9	21.1	1450	66.0	7.5	1.8
	137.3	38.2	18.8		75.0	11	2.0
	164.8	45.8	16.6		73.0	11	2.3
XA(T)100/26C	79.0	22.0	19.3	1450	65.0	7.5	1.8
	131.7	36.6	17.0		73.5	11	2.0
	158.1	43.9	14.9		71.0	11	2.3
XA(T)100/26D	75.7	21.0	17.6	1450	62.0	7.5	1.8
	126.1	35.0	15.3		72.0	11	2.0
	151.4	42.0	13.2		69.0	11	2.3
XA(T)100/26E	72.3	20.1	16.0	1450	62.0	7.5	1.8
	120.5	33.5	13.6		72.0	7.5	2.0
	144.6	40.2	11.5		68.5	11	2.3
XA(T)100/26F	69.0	19.2	14.4	1450	59.0	7.5	1.8
	114.9	31.9	12.0		68.0	7.5	2.0
	137.9	38.3	10.0		64.0	7.5	2.3

Technical Parameter

Model	Capacity		Head (m)	Speed (r/min)	Eff. (%)	Motor power (kW)	NPSHr (mm)
	m³/h	L/s					
XA(T)100/32	81.0	22.5	38.0	1450	68.0	15	2.0
	135.0	37.5	34.0		77.6	22	2.2
	162.0	45.0	30.2		73.0	22	2.7
XA(T)100/32A	77.6	21.5	34.4	1450	67.0	15	2.0
	129.3	35.9	31.0		76.2	18.5	2.2
	155.1	43.1	27.6		72.0	22	2.7
XA(T)100/32B	73.9	20.5	31.1	1450	66.0	15	2.0
	123.1	34.2	28.0		74.0	18.5	2.2
	147.7	41.0	25.0		71.0	18.5	2.7
XA(T)100/32C	70.2	19.5	28.2	1450	65.0	11	2.0
	116.9	32.5	25.0		71.5	15	2.2
	140.3	39.0	22.1		66.5	15	2.7
XA(T)100/32D	66.5	18.5	25.7	1450	62.0	11	2.0
	110.8	30.8	22.3		68.0	11	2.2
	132.9	36.9	19.8		64.5	15	2.7
XA(T)100/32E	62.8	17.4	22.9	1450	59.0	11	2.0
	104.6	29.1	19.8		65.0	11	2.2
	125.6	34.9	16.8		60.0	15	2.7
XA(T)100/40	90.7	25.2	56.8	1450	62.0	30	1.5
	151.2	42.0	51.8		71.0	37	1.8
	181.4	50.4	47.0		67.5	45	2.1
XA(T)100/40A	87.6	24.3	52.4	1450	61.0	30	1.5
	146.0	40.6	47.4		69.5	37	1.8
	175.2	48.7	42.6		66.0	37	2.1
XA(T)100/40B	84.3	23.4	48.2	1450	60.0	30	1.5
	140.5	39.0	43.4		67.0	37	1.8
	168.6	46.8	38.8		65.5	37	2.1
XA(T)100/40C	81.0	22.5	44.5	1450	58.0	22	1.5
	134.9	37.5	39.5		66.5	30	1.8
	161.9	45.0	35.0		64.0	30	2.1
XA(T)100/40D	77.6	21.6	40.6	1450	57.5	18.5	1.5
	129.4	35.9	35.9		65.0	22	1.8
	155.3	43.1	31.7		62.5	30	2.1
XA(T)100/40E	74.3	20.6	37.5	1450	56.0	18.5	1.5
	123.8	34.4	32.9		64.0	22	1.8
	148.6	41.3	28.8		61.0	22	2.1
XA(T)100/40F	71.0	19.7	34.0	1450	55.0	15	1.5
	118.3	32.9	29.8		63.0	18.5	1.8
	142.0	39.4	25.8		59.0	22	2.1
XA(T)125/20	114.5	31.8	15.0	1450	62.0	11	1.3
	190.8	53.0	13.3		79.0	11	1.7
	229.0	63.6	11.7		78.5	11	1.9
XA(T)125/20A	109.7	30.5	13.3	1450	61.0	11	1.3
	182.8	50.8	11.5		77.0	11	1.7
	219.3	60.9	9.9		76.0	11	1.9
XA(T)125/20B	104.3	29.0	11.7	1450	59.0	7.5	1.3
	173.9	48.3	9.7		75.0	7.5	1.7
	208.6	58.0	8.1		72.0	7.5	1.9
XA(T)125/20C	99.0	27.5	10.2	1450	58.0	7.5	1.3
	164.9	45.8	8.0		70.0	7.5	1.7
	197.9	55.0	6.3		66.0	7.5	1.9

Model	Capacity		Head (m)	Speed (r/min)	Eff. (%)	Motor power (kW)	NPSHr (mm)
	m³/h	L/s					
XA(T)125/26	144.0	40.0	24.0	1450	71.0	18.5	2.2
	240.0	66.7	22.2		84.0	22	2.8
	288.0	80.0	20.5		83.5	22	3.3
XA(T)125/26A	139.1	38.6	21.9	1450	71.0	15	2.2
	231.8	64.4	20.1		83.5	18.5	2.8
	278.2	77.3	18.3		83.0	22	3.3
XA(T)125/26B	133.6	37.1	20.0	1450	70.0	15	2.2
	222.7	61.9	18.3		83.0	18.5	2.8
	267.3	74.2	16.5		81.5	18.5	3.3
XA(T)125/26C	128.2	35.6	18.3	1450	70.0	11	2.2
	213.6	59.3	16.4		81.0	15	2.8
	256.4	71.2					

Technical Parameter

Model	Capacity		Head (m)	Speed (r/min)	Eff. (%)	Motor power (kW)	NPSHr (mm)
	m³/h	L/s					
XA(T)125/50	172.8	48.0	95.1	1450	59.0	90	2.0
	288.0	80.0	93.8		71.0	132	2.6
	345.6	96.0	91.0		72.5	160	3.9
XA(T)125/50A	164.6	45.7	86.7	1450	59.0	75	2.0
	274.3	76.2	85.5		70.5	110	2.6
	329.1	91.4	83.1		72.5	132	3.9
XA(T)125/50B	156.3	43.4	78.1	1450	58.5	75	2.0
	260.6	72.4	76.8		70.0	90	2.6
	312.7	86.9	74.6		72.0	110	3.9
XA(T)125/50C	148.1	41.1	69.9	1450	58.0	55	2.0
	246.9	68.6	68.5		69.0	75	2.6
	296.2	82.3	66.6		72.0	90	3.9
XA(T)125/50D	139.9	38.9	61.9	1450	57.0	55	2.0
	233.1	64.8	60.7		68.5	75	2.6
	279.8	77.7	59.0		71.5	75	3.9
XA(T)125/50E	131.7	36.6	54.2	1450	57.0	45	2.0
	219.4	61.0	52.8		67.0	55	2.6
	263.3	73.1	51.4		71.0	75	3.9
XA(T)150/20	216.0	60.0	14.1	1450	62.0	18.5	3.0
	360.0	100.0	12.2		80.0	18.5	3.5
	432.0	120.0	10.6		75.5	18.5	4.0
XA(T)150/20A	206.9	57.5	12.8	1450	61.0	15	3.0
	344.9	95.8	10.8		78.0	15	3.5
	413.8	115.0	9.2		73.0	18.5	4.0
XA(T)150/20B	196.8	54.7	11.5	1450	59.0	15	3.0
	328.0	91.1	9.5		75.5	15	3.5
	393.6	109.3	7.8		70.0	15	4.0
XA(T)150/20C	186.7	51.9	10.2	1450	57.0	11	3.0
	311.2	86.4	8.2		71.0	15	3.5
	373.5	103.7	6.6		65.0	15	4.0
XA(T)150/20D	176.6	49.1	8.9	1450	53.0	11	3.0
	294.4	81.8	6.9		66.0	11	3.5
	353.3	98.1	5.3		59.0	11	4.0
XA(T)150/26	194.4	54.0	23.1	1450	72.0	22	1.7
	324.0	90.0	21.0		81.5	30	2.1
	388.8	108.0	17.9		75.0	30	4.0
XA(T)150/26A	187.8	52.2	21.2	1450	72.0	18.5	1.7
	313.0	86.9	18.9		79.0	30	2.1
	375.5	104.3	15.6		72.0	30	4.0
XA(T)150/26B	180.4	50.1	19.3	1450	71.0	18.5	1.7
	300.7	83.5	16.7		77.0	22	2.1
	360.8	100.2	13.4		68.0	22	4.0
XA(T)150/26C	173.0	48.1	17.6	1450	70.0	15	1.7
	288.4	80.1	14.7		74.5	18.5	2.1
	346.1	96.1	11.2		64.0	18.5	4.0
XA(T)150/26D	165.7	46.0	15.9	1450	67.0	15	1.7
	276.1	76.7	12.6		72.0	18.5	2.1
	331.4	92.0	9.3		59.0	18.5	4.0
XA(T)150/26E	158.3	44.0	14.2	1450	65.0	11	1.7
	263.9	73.3	10.3		64.0	15	2.1
	316.6	88.0	7.1		51.0	15	4.0

Model	Capacity		Head (m)	Speed (r/min)	Eff. (%)	Motor power (kW)	NPSHr (mm)
	m³/h	L/s					
XA(T)150/32	222.0	61.7	36.0	1450	73.0	37	2.1
	370.0	102.8	34.0		84.5	55	3.0
	444.0	123.3	31.2		83.5	55	4.0
XA(T)150/32A	212.6	59.0	32.7	1450	73.0	30	2.1
	354.3	98.4	30.3		83.0	45	3.0
	425.1	118.1	27.1		81.0	45	4.0
XA(T)150/32B	202.4	56.2	29.3	1450	72.0	30	2.1
	337.4	93.7	26.6		81.0	37	3.0
	404.9	112.5	23.4		79.0	37	4.0
XA(T)150/32C	192.3	53.4	26.2	1450	71.0	22	2.1
	320.5	89.0	23.0		79.0	30	3.0
	384.6	106.8	19.7		76.0	30	4.0
XA(T)150/32D	182.2	50.6	23.2	1450	70.0	22	2.1
	303.7	84.3	19.8		77.0	30	3.0
	364.4	101.2	16.5		73.0	30	4.0
XA(T)150/32E	172.1	47.8	20.2	1450	69.0	18.5	2.1
	286.8	79.7	16.6		75.0	22	3.0
	344.1	95.6	13.0		69.0	22	4.0
XA(T)150/40	231.0	64.2	54.5	1450	67.0	75	2.0
	385.0	106.9	49.5		81.5	75	3.3
	462.0	128.3	43.9		78.0	90	4.6
XA(T)150/40A	223.1	62.0	50.0	1450	66.0	55	2.0
	371.8	103.3	45.3		80.0	75	3.3
	446.2	123.9	39.8		77.0	75	4.6
XA(T)150/40B	214.6	59.6	46.0	1450	66.0	55	2.0
	357.7	99.4	41.4		79.0	75	3.3
	429.2	119.2	36.0		76.0	75	4.6
XA(T)150/40C	206.1	57.3	42.4	1450	66.0	45	2.0
	343.6	95.4	37.7		77.0	55	3.3
	412.3	114.5	32.8		74.0	55	4.6
XA(T)150/40D	197.7	54.9	38.6	1450	65.0	37	2.0
	329.4	91.5	34.1		76.0	45	3.3
	395.3	109.8	29.6		75.5	45	4.6
XA(T)150/40E	189.2	52.6	35.4	1450	64.0	37	2.0
	315.3	87.6	31.2		73.0	45	3.3
	378.4	105.1	27.0		72.0	45	4.6
XA(T)150/40F	180.7	50.2	32.1	1450	63.5	30	2.0
	301.2	83.7	28.4		73.0	37	3.3
	361.5	100.4	24.4		72.0	37	4.6
XA150/50	289.4	80.4	98.0	1450	67.0	132	2.2
	482.4	134.0	93.8		78.5	200	4.1
	578.9	160.8	89.5		79.0	200	6.0
XA150/50A	275.7	76.6	88.9	1450	66.5	132	2.2
	459.4	127.6	84.8		78.0	160	4.1
	551.3	153.1	80.5		78.0	160	6.0
XA150/50B	261.9	72.7	80.3	1450	66.0	110	2.2
	436.5	121.2	75.8		76.0	160	4.1
	523.7	145.5	71.7		76.0	160	6.0
XA150/50C	248.1	68.9	72.0	1450	65.0	90	2.2
	413.5	114.9	67.3		75.0	132	4.1
	496.2	137.8	63.2		75.0	132	6.0
XA150/50D	234.3	65.1	63.4	1450	64.0	75	2.2
	390.5	108.5	58.9		74.0	110	4.1
	468.6	130.2	55.0		74.0	110	6.0
XA150/50E	220.5	61.3	55.8	1450	63.0	75	2.2
	367.5	102.1	51.8		72.0	90	4.1
	441.1	122.5	48.4		73.0	90	6.0

Technical Parameter

Model	Capacity		Head (m)	Speed (r/min)	Eff. (%)	Motor power (kW)	NPSHr (mm)
	m³/h	L/s					
XA200/26	259.2	72.0	20.4	1450	62.0	30	3.0
	432.0	120.0	16.1		80.0	30	4.5
	518.4	144.0	12.8		76.0	30	5.5
XA200/26A	243.0	67.5	16.8	1450	60.0	22	3.0
	405.0	112.5	13.2		76.0	22	4.5
	486.0	135.0	10.4		71.0	22	5.5
XA200/26B	229.5	63.8	13.3	1450	57.0	18.5	3.0
	382.5	106.3	10.1		70.0	18.5	4.5
	459.0	127.5	7.5		62.0	18.5	5.5
XA200/32	378.0	105.0	32.1	1450	73.0	55	3.5
	630.0	175.0	27.9		84.0	75	4.0
	756.0	210.0	23.6		78.5	75	4.7
XA200/32A	361.9	100.5	29.2	1450	72.0	45	3.5
	603.2	167.6	25.0		82.0	55	4.0
	723.8	201.1	21.0		77.0	55	4.7
XA200/32B	344.7	95.7	26.7	1450	69.0	45	3.5
	574.5	159.6	23.2		81.0	55	4.0
	689.4	191.5	20.0		78.5	55	4.7
XA200/32C	327.4	91.0	24.0	1450	67.0	37	3.5
	545.7	151.6	20.1		79.0	45	4.0
	654.9	181.9	16.8		75.0	45	4.7
XA200/32D	310.2	86.2	21.5	1450	65.0	37	3.5
	517.0	143.6	17.7		76.0	37	4.0
	620.4	172.3	14.6		72.5	37	4.7
XA200/32E	293.0	81.4	19.0	1450	62.0	30	3.5
	488.3	135.6	15.6		73.0	37	4.0
	586.0	162.8	12.7		70.0	37	4.7
XA200/40	391.0	108.6	55.5	1450	73.0	90	3.1
	651.6	181.0	49.5		84.0	132	3.9
	781.9	217.2	41.8		79.0	132	4.9
XA200/40A	377.6	104.9	51.7	1450	72.0	90	3.1
	629.3	174.8	45.7		83.0	110	3.9
	755.2	209.8	38.2		77.0	110	4.9
XA200/40B	363.2	100.9	47.7	1450	71.0	75	3.1
	605.4	168.2	42.0		83.0	110	3.9
	726.5	201.8	34.7		76.5	110	4.9
XA200/40C	348.9	96.9	43.3	1450	70.0	75	3.1
	581.5	161.5	37.7		82.0	90	3.9
	697.8	193.8	31.0		75.0	90	4.9
XA200/40D	334.6	92.9	39.7	1450	69.0	75	3.1
	557.6	154.9	34.3		80.0	75	3.9
	669.1	185.9	27.4		72.0	75	4.9
XA200/40E	320.2	89.0	36.4	1450	67.0	55	3.1
	533.7	148.3	31.0		79.5	75	3.9
	640.4	177.9	24.0		69.0	75	4.9
XA200/40F	305.9	85.0	33.4	1450	65.0	55	3.1
	509.8	141.6	28.2		76.0	75	3.9
	611.8	169.9	21.5		66.0	75	4.9

Model	Capacity		Head (m)	Speed (r/min)	Eff. (%)	Motor power (kW)	NPSHr (mm)
	m³/h	L/s					
XA200/50	259.2	72.0	20.4	1450	62.0	30	3.0
	432.0	120.0	16.1		80.0	30	4.5
	518.4	144.0	12.8		76.0	30	5.5
XA200/50A	243.0	67.5	16.8	1450	60.0	22	3.0
	405.0	112.5	13.2		76.0	22	4.5
	486.0	135.0	10.4		71.0	22	5.5
XA200/50B	229.5	63.8	13.3	1450	57.0	18.5	3.0
	382.5	106.3	10.1		70.0	18.5	4.5
	459.0	127.5	7.5		62.0	18.5	5.5
XA200/50C	378.0	105.0	32.1	1450	73.0	55	3.5
	630.0	175.0	27.9		84.0	75	4.0
	756.0	210.0	23.6		78.5	75	4.7
XA200/50D	361.9	100.5	29.2	1450	72.0	45	3.5
	603.2						

Technical Parameter

Model	Capacity		Head (m)	Speed (r/min)	Eff. (%)	Motor power (kW)	NPSHr (mm)
	m³/h	L/s					
XA250/50	587.5	163.2	87.5	1450	70.0	250	2.5
	979.2	272.0	81.5		83.5	315	3.7
	1175.0	326.4	75.5		85.0	315	4.7
XA250/50A	559.5	155.4	79.8	1450	69.0	200	2.5
	932.6	259.0	74.5		83.3	250	3.7
	1119.1	310.9	69.0		84.0	315	4.7
XA250/50B	531.6	147.7	75.0	1450	69.0	200	2.5
	885.9	246.1	67.5		83.2	250	3.7
	1063.1	295.3	62.7		84.0	250	4.7
XA250/50C	503.6	139.9	65.0	1450	67.0	160	2.5
	839.3	233.1	60.5		83.0	200	3.7
	1007.2	279.8	56.0		84.0	200	4.7
XA250/50D	475.6	132.1	58.0	1450	65.0	132	2.5
	792.7	220.2	53.6		81.0	160	3.7
	951.2	264.2	49.3		83.0	160	4.7
XA250/50E	447.6	124.3	50.8	1450	52.0	132	2.5
	746.1	207.2	46.5		79.0	132	3.7
	895.3	248.7	42.5		80.0	160	4.7

Model	Capacity		Head (m)	Speed (r/min)	Eff. (%)	Motor power (kW)	NPSHr (mm)
	m³/h	L/s					
XA300/40	702.0	195.0	49.5	1450	69.0	160	3.0
	1170.0	325.0	40.8		87.0	200	3.5
	1404.0	390.0	38.7		87.0	200	4.1
XA300/40A	678.0	188.3	46.2	1450	68.0	160	3.0
	1130.0	313.9	40.6		86.5	160	3.5
	1355.9	376.7	35.5		86.0	160	4.1
XA300/40B	652.2	181.2	43.1	1450	66.0	132	3.0
	1087.0	302.0	37.6		84.7	160	3.5
	1304.4	362.3	32.1		84.2	160	4.1
XA300/40C	626.5	174.0	39.2	1450	64.0	132	3.0
	1044.1	290.0	34.0		84.0	132	3.5
	1253.0	348.0	29.0		83.0	132	4.1
XA300/40D	600.7	166.9	35.8	1450	61.0	110	3.0
	1001.2	278.1	30.8		81.0	132	3.5
	1201.5	333.7	26.0		80.5	132	4.1
XA300/40E	575.0	159.7	32.5	1450	57.0	110	3.0
	958.3	266.2	27.5		78.0	110	3.5
	1150.0	319.4	22.4		76.0	110	4.1
XA300/40F	549.2	152.6	29.2	1450	54.0	110	3.0
	915.4	254.3	24.2		74.0	90	3.5
	1098.5	305.1	19.9		72.0	90	4.1

Dimensions of XA Series Bare Shaft Pump

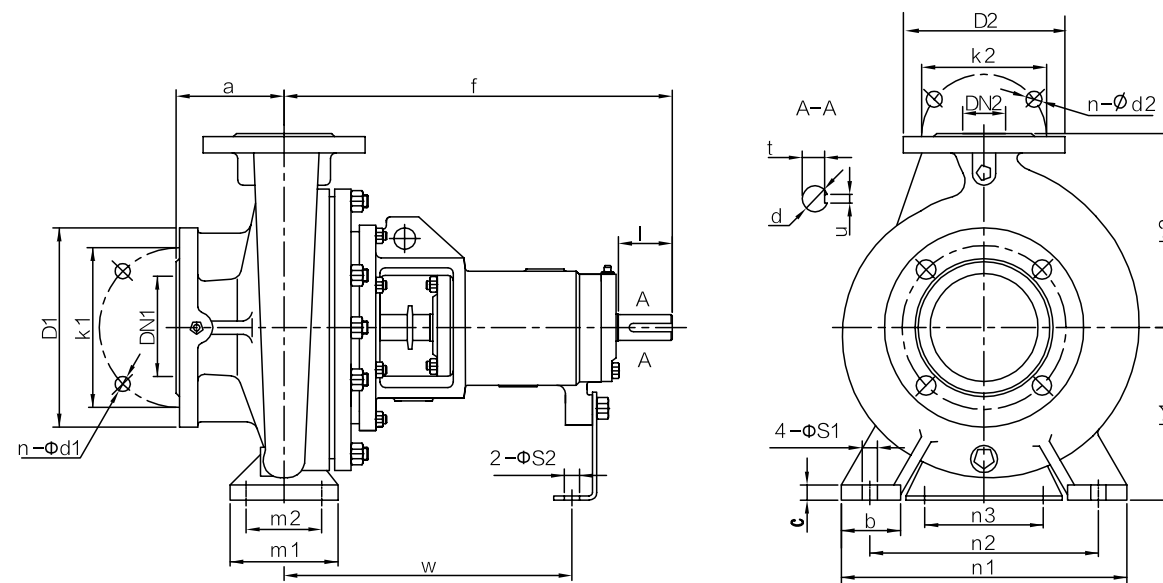

Flange dimensions PN1.6 MPa

DN1/DN2	32	40	50	65	80	100	125	150	200	250	300	350	400
D1/D2	140	150	165	185	200	220	250	285	340	405	460	520	580
K1/K2	100	110	125	145	160	180	210	240	295	355	410	470	525
n-d1/n-d2	4-φ18	4-φ18	4-φ18	4-φ18	8-φ18	8-φ18	8-φ18	8-φ22	12-φ22	12-φ26	12-φ26	16-φ26	16-φ30

Model	ID of bearing	Dis. DN2	Suc. DN1	a	f	h1	h2	b	c	n3	m1	m2	n1	n2	S1	S2	w	d	l	t	u	Weight (kg)
XA32/13	25	32	50	80	360	112	140	50	14	100	100	70	190	140	14	14	267	24	50	27	8	29
XA32/16	25	32	50	80	360	132	160	50	14	100	100	70	240	190	14	14	267	24	50	27	8	35
XA32/20	25	32	50	80	360	160	180	50	14	110	100	70	240	190	14	14	267	24	50	27	8	47
XA32/26	25	32	50	100	360	180	225	65	14	110	125	95	320	250	14	14	267	24	50	27	8	58
XA40/13	25	40	65	80	360	112	140	50	14	100	100	70	210	160	14	14	267	24	50	27	8	31
XA40/16	25	40	65	80	360	132	160	50	14	100	100	70	240	190	14	14	267	24	50	27	8	34
XA40/20	25	40	65	100	360	160	180	50	14	110	100	70	265	212	14	14	267	24	50	27	8	45
XA40/26	25	40	65	100	360	180	225	65	14	110	125	95	320	250	14	14	267	24	50	27	8	61
XA40/32	35	40	65	125	470	200	250	65	14	110	125	95	345	280	14	14	342	32	80	35	10	94
XA50/13	25	50	65	100	360	132	160	50	14	100	100	70	240	190	14	14	267	24	50	27	8	35
XA50/16	25	50	65	100	360	160	180	50	14	110	100	70	265	212	14	14	267	24	50	27	8	39
XA50/20	25	50	65	100	360	160	200	50	14	110	100	70	265	212	14	14	267	24	50	27	8	49

Model	ID of bearing	Dis. DN2	Suc. DN1	a	f	h1	h2	b	c	n3	m1	m2	n1	n2	S1	S2	w	d	l	t	u	Weight (kg)
XA50/26	25	50	65	100	360	180	225	65	14	110	125	95	320	250	14	14	267	24	50	27	8	68
XA50/32	35	50	65	125	470	225	280	65	18	110	125	95	345	280	14	14	342	32	80	35	10	113
XA65/13	25	65	80	100	360	160	180	65	14	110	125	95	280	212	14	14	267	24	50	27	8	41
XA65/16	25	65	80	100	360	160	200	65	14	110	125	95	280	212	14	14	267	24	50	27	8	47
XA65/20	35	65	80	100	465	180	225	65	14	110	125	95	320	250	14	14	339	32	80	35	10	55
XA65/26	35	65	80	100	470	200	250	80	15	110	160	120	360	280	18	14	342	32	80	35	10	87
XA65/32	35	65	80	125	470	225	280	80	18	110	160	120	400	315	18	14	342	32	80	35	10	110
XA80/16	25	80	100	125	360	180	225	65	14	110	125	95	320	250	14	14	267	24	50	27	8	53
XA80/20	35	80	100	125	470	180	250	65	15	110	125	95	345	280	14	14	342	32	80	35	10	76
XA80/26	35	80	100	125	470	200	280	80	15	110	160	120	400	315	18	14	342	32	80	35	10	95
XA80/32	35	80	100	125	470	250	315	80	16	110	160	120	400	315	18	14	342	32	80	35	10	118
XA80/40	45	80	100	125	530	280	355	83	18	110	160	120	440	340	18	14	370	42	110	45	12	160
XA100/16	35	100	125	125	470	200	250	80	15	110	160	120	360	280	18	14	342	32	80	35	10	87
XA100/20	35	100	125	125	470	200	280	80	16	110	160	120	360	280	18	14	342	32	80	35	10	94
XA100/26	35	100	125	140	470	225	280	80	16	110	160	120	400	315	18	14	342	32	80	35	10	102
XA100/32	35	100	125	140	470	250	315	80	16	110	160	120	400	315	18	14	342	32	80	35	10	118
XA100/40	45	100	125	140	530	280	355	100	20	110	200	150	500	400	23	14	370	42	110	45	12	176
XA125/20	35	125	150	140	470	250	315	80	16	110	160	120	400	315	18	14	342	32	80	35	10	112
XA125/26	35	125	150	140	470	250	355	80	16	110	160	120	400	315	18	14	342	32	80	35	10	117
XA125/32	45	125	150	140	470	280	355	100	18	110	200	150	500	400	23	14	370	42	110	45	12	155
XA125/40	45	125	150	160	530	315	400	100	18	110	200	150	500	400	23	14	370	42	110	45	12	178
XA125/50	55	125	150	160	670	355	450	100	25	110	200	150	550	450	23	14	500	48	110	51	14	300
XA150/20	35	150	200	160	500	280	400	100	18	110	200	150	400	315	23	14	342	32	80	35	10	132
XA150/26	45	150	200	160	530	250	355	100	18	110	200	150	450	350	23	14	370	42	110	45	12	163
XA150/32	45	150	200	160	530	280	400	100	18	110	200	150	550	450	23	14	370	42	110	45	12	170
XA150/40	45	150	200	160	530	315	450	100	18	110	200	150	550	450	23	14	370	42	110	45	12	207
XA150/50	55	150	200	180	670	375	500	100	22	110	200	150	550	450	23	14	500	48	110	51	14	330
XA200/26	45	200	250	180	555	315	450	100	20	110	200	150	550	450	28	14	392	42	110	45	12	219
XA200/32	55	200	250	180	670	315	480	120	20	110	220	170	600	480	28	14	505	48	110	51	14	286
XA200/40	55	200	250	180	670	335	480	120	20	110	250	170	600	480	28	14	505	48	110	51	14	328
XA200/50	65	200	250	200	720	425	560	100	22	140	200	150	660	560	23	19	515	60	140	64	18	450
XA250/32	55	250	300	220	691	355	520	150	26	110	250	200	660	510	28	14	525	48	110	51	14	366
XA250/40	55	250	300	220	682	400	560	150	26	110	250	200	660	510	28	14	516	48	110	51	14	396
XA250/50	65	250	300	250	720	450	670	120	32	140	240	190	750	650	23	19	515	60	140	64	18	550
XA300/40	65	300	350	300	720	425	670	120	30	140	250	190	760	660	30	19	515	60	140	64	18	5

Dimensions of XA Series Long Coupled Pump with Motor

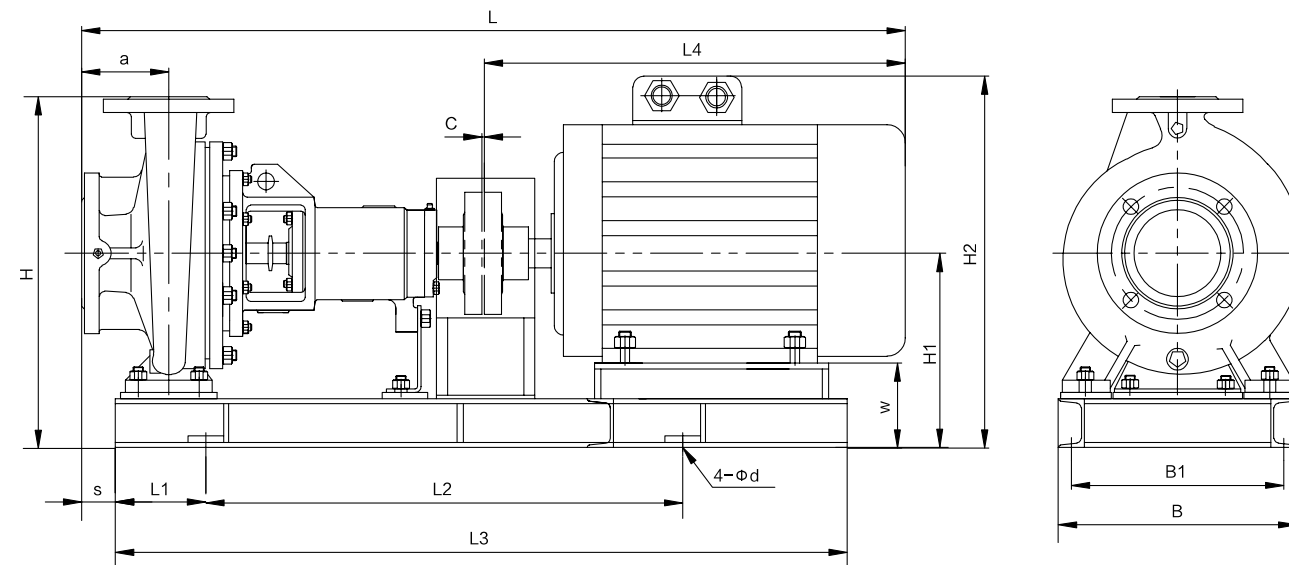

Model	Motor(B3)		a	H	c	L4	H1	H2	L	L1	L2	L3	s	w	B1	B	φd	Weight (kg)
	Frame size	Power kW																
XA32/13-4KW/2	112M-2	4	80	312	4	400	172	360	844	80	560	750	25	60	294	330	16	93
XA32/13-3KW/2	100L-2	3	80	312	4	385	172	342	829	80	560	750	25	60	244	280	16	91
XA32/13-2.2KW/2	90L-2	2.2	80	312	4	345	172	332	789	80	560	750	25	60	244	280	16	73
XA32/13-1.5KW/2	90S-2	1.5	80	312	4	320	172	332	764	80	560	750	25	60	244	280	16	69
XA32/13-1.1KW/2	802-2	1.1	80	312	4	295	172	312	739	80	560	750	25	60	244	280	16	65
XA32/13-0.75KW/2	801-2	0.75	80	312	4	295	172	312	739	80	560	750	25	60	244	280	16	64
XA32/13-0.55KW/2	801-4	0.55	80	312	4	295	172	312	739	80	560	750	25	60	244	280	16	64
XA32/16-7.5KW/2	132S2-2	7.5	80	365	4	470	205	418	914	70	630	800	25	73	317	350	18	135
XA32/16-5.5KW/2	132S1-2	5.5	80	365	4	470	205	418	914	70	630	800	25	73	317	350	18	131
XA32/16-4KW/2	112M-2	4	80	352	4	400	192	380	844	80	560	750	25	60	294	330	16	99
XA32/16-3KW/2	100L-2	3	80	352	4	385	192	362	829	80	560	750	25	60	294	330	16	100
XA32/16-2.2KW/2	90L-2	2.2	80	352	4	345	192	352	789	80	560	750	25	60	294	330	16	81
XA32/16-1.5KW/2	90S-2	1.5	80	352	4	320	192	352	764	80	560	750	25	60	294	330	16	77
XA32/16-1.5KW/4	90L-4	1.5	80	352	4	345	192	352	789	80	560	750	25	60	294	330	16	82
XA32/16-1.1KW/4	90S-4	1.1	80	352	4	320	192	352	764	80	560	750	25	60	294	330	16	78
XA32/16-0.75KW/4	802-4	0.75	80	352	4	295	192	332	739	80	560	750	25	60	294	330	16	73
XA32/16-0.55KW/4	801-4	0.55	80	352	4	295	192	332	739	80	560	750	25	60	294	330	16	72
XA32/20-15KW/2	160M2-2	15	80	413	4	605	233	473	1049	70	780	1000	12.5	73	387	420	18	195
XA32/20-11KW/2	160M1-2	11	80	413	4	605	233	473	1049	70	780	1000	12.5	73	387	420	18	194
XA32/20-7.5KW/2	132S2-2	7.5	80	413	4	470	233	446	914	70	630	800	12.5	73	317	350	18	148

Dimensions of XA Series Long Coupled Pump with Motor

Model	Motor(B3)		a	H	c	L4	H1	H2	L	L1	L2	L3	s	w	B1	B	φd	Weight (kg)
	Frame size	Power kW																
XA32/20-5.5KW/2	132S1-2	5.5	80	413	4	470	233	446	914	70	630	800	12.5	73	317	350	18	144
XA32/20-4KW/2	112M-2	4	80	400	4	400	220	408	844	80	560	750	12.5	60	294	330	16	112
XA32/20-2.2KW/4	100L1-4	2.2	80	400	4	385	220	390	829	80	560	750	12.5	60	294	330	16	103
XA32/20-1.5KW/4	90L-4	1.5	80	400	4	345	220	380	789	80	560	750	12.5	60	294	330	16	95
XA32/20-1.1KW/4	90S-4	1.1	80	400	4	320	220	380	764	80	560	750	12.5	60	294	330	16	91
XA32/20-0.75KW/4	802-4	0.75	80	400	4	295	220	360	739	80	560	750	12.5	60	294	330	16	86
XA32/20-0.55KW/4	801-4	0.55	80	400	4	295	220	360	739	80	560	750	12.5	60	294	330	16	85
XA32/26-30KW/2	200L1-2	30	100	515	4	765	290	590	1229	85	750	1100	32.5	90	417	460	18	340
XA32/26-22KW/2	180M-2	22	100	478	4	690	253	513	1154	70	780	1000	32.5	73	387	420	18	259
XA32/26-18.5KW/2	160L-2	18.5	100	478	4	660	253	493	1124	70	780	1000	32.5	73	387	420	18	229
XA32/26-15KW/2	160M2-2	15	100	478	4	605	253	493	1069	70	780	1000	32.5	73	387	420	18	206
XA32/26-11KW/2	160M1-2	11	100	478	4	605	253	493	1069	70	780	1000	32.5	73	387	420	18	205
XA32/26-4KW/4	112M-4	4	100	478	4	400	253	441	864	70	630	800	32.5	73	387	420	18	133
XA32/26-3KW/4	100L2-4	3	100	478	4	385	253	423	849	70	630	800	32.5	73	387	420	18	123
XA32/26-2.2KW/4	100L1-4	2.2	100	478	4	385	253	423	849	70	630	800	32.5	73	387	420	18	120
XA32/26-1.5KW/4	90L-4	1.5	100	478	4	345	253	413	809	70	630	800	32.5	73	387	420	18	112
XA40/13-7.5KW/2	132S2-2	7.5	80	345	4	470	205	418	914	70	630	800	25	73	317	350	18	132
XA40/13-5.5KW/2	132S1-2	5.5	80	345	4	470	205	418	914	70	630	800	25	73	317	350	18	128
XA40/13-4KW/2	112M-2	4	80	312	4	400	172	360	844	80	560	750	25	60	294	330	16	95
XA40/13-3KW/2	100L-2	3	80	312	4	385	172	342	829	80	560	750	25	60	244	280	16	93
XA40/13-2.2KW/2	90L-2	2.2	80	312	4	345	172	332	789	80	560	750	25	60	244	280	16	75
XA40/13-1.5KW/2	90S-2	1.5	80	312	4	320	172	332	764	80	560	750	25	60	244	280	16	71
XA40/13-1.1KW/4	90S-4	1.1	80	312	4	320	172	332	764	80	560	750	25	60	244	280	16	72
XA40/13-0.75KW/4	802-4	0.75	80	312	4	295	172	312	739	80	560	750	25	60	244	280	16	67
XA40/13-0.55KW/4	801-4	0.55	80	312	4	295	172	312	739	80	560	750	25	60	244	280	16	66
XA40/16-11KW/2	160M1-2	11	80	393	4	605	233	473	1049	70	780	1000	25	73	387	420	18	182
XA40/16-7.5KW/2	132S2-2	7.5	80	365	4	470	205	418	914	70	630	800	25	73	317	350	18	134
XA40/16-5.5KW/2	132S1-2	5.5	80	365	4	470	205	418	914	70	630	800	25	73	317	350	18	130
XA40/16-4KW/2	112M-2	4	80	352	4	400	192	380	844	80	560	750	25	60	294	330	16	98
XA40/16-3KW/2	100L-2	3	80	352	4	385	192	362	829	80	560	750	25	60	294	330	16	99
XA40/16-1.5KW/4	90L-4	1.5	80	352	4	345	192	352	789	80	560	750	25	60	294	330	16	81
XA40/16-1.1KW/4	90S-4	1.1	80	352	4	320	192	352	764	80	560	750	25	60	294	330	16	77
XA40/16-0.75KW/4	802-4	0.75	80	352	4	295	192	332	739	80	560	750	25	60	294	330	16	72
XA40/16-0.55KW/4	801-4	0.55	80	352	4	295	192	332	739	80	560	750	25	60	294	330	16	71

Dimensions of XA Series Long Coupled Pump with Motor

Model	Motor(B3)		a	H	c	L4	H1	H2	L	L1	L2	L3	s	w	B1	B	φd	Weight (kg)
	Frame size	Power kW																
XA40/20-18.5KW/2	160L-2	18.5	100	413	4	660	233	473	1124	70	780	1000	32.5	73	387	420	18	216
XA40/20-15KW/2	160M2-2	15	100	413	4	605	233	473	1069	70	780	1000	32.5	73	387	420	18	192
XA40/20-11KW/2	160M1-2	11	100	413	4	605	233	473	1069	70	780	1000	32.5	73	387	420	18	191
XA40/20-7.5KW/2	132S2-2	7.5	100	413	4	470	233	446	934	70	630	800	32.5	73	317	350	18	146
XA40/20-5.5KW/2	132S1-2	5.5	100	413	4	470	233	446	934	70	630	800	32.5	73	317	350	18	142
XA40/20-3KW/4	100L2-4	3	100	400	4	385	220	390	849	80	560	750	32.5	60	294	330	16	104
XA40/20-2.2KW/4	100L1-4	2.2	100	400	4	385	220	390	849	80	560	750	32.5	60	294	330	16	101
XA40/20-1.5KW/4	90L-4	1.5	100	400	4	345	220	380	809	80	560	750	32.5	60	294	330	16	93
XA40/20-1.1KW/4	90S-4	1.1	100	400	4	320	220	380	784	80	560	750	32.5	60	294	330	16	89
XA40/20-0.75KW/4	802-4	0.75	100	400	4	295	220	360	759	80	560	750	32.5	60	294	330	16	84
XA40/26-37KW/2	200L2-2	37	100	515	4	765	290	590	1229	85	750	1100	34.5	90	417	460	18	353
XA40/26-30KW/2	200L1-2	30	100	515	4	765	290	590	1229	85	750	1100	34.5	90	417	460	18	343
XA40/26-22KW/2	180M-2	22	100	478	4	690	253	513	1154	70	780	1000	34.5	73	387	420	18	262
XA40/26-18.5KW/2	160L-2	18.5	100	478	4	660	253	493	1124	70	780	1000	34.5	73	387	420	18	232
XA40/26-15KW/2	160M2-2	15	100	478	4	605	253	493	1069	70	780	1000	34.5	73	387	420	18	209
XA40/26-11KW/2	160M1-2	11	100	478	4	605	253	493	1069	70	780	1000	34.5	73	387	420	18	208
XA40/26-5.5KW/4	132S-4	5.5	100	478	4	470	253	466	934	70	680	900	34.5	73	387	420	18	162
XA40/26-4KW/4	112M-4	4	100	478	4	400	253	441	864	70	630	800	34.5	73	387	420	18	136
XA40/26-3KW/4	100L2-4	3	100	478	4	385	253	423	849	70	630	800	34.5	73	387	420	18	126
XA40/26-2.2KW/4	100L1-4	2.2	100	478	4	385	253	423	849	70	630	800	34.5	73	387	420	18	123
XA40/26-1.5KW/4	90L-4	1.5	100	478	4	345	253	413	809	70	630	800	34.5	73	387	420	18	115
XA40/32G-45KW/2	225M-2	45	125	565	4	805	315	640	1460	70	940	1300	57.5	90	457	500	18	459
XA40/32G-37KW/2	200L2-2	37	125	540	4	765	290	590	1420	70	940	1300	57.5	90	417	460	18	399
XA40/32G-30KW/2	200L1-2	30	125	540	4	765	290	590	1420	70	940	1300	57.5	90	417	460	18	389
XA40/32G-22KW/2	180M-2	22	125	523	4	690	273	533	1345	80	950	1150	57.5	73	387	420	18	309
XA40/32H-45KW/2	225M-2	45	125	565	4	805	315	640	1404	70	900	1200	57.5	90	457	500	18	446
XA40/32H-37KW/2	200L2-2	37	125	540	4	765	290	590	1364	70	850	1200	57.5	90	417	460	18	386
XA40/32H-30KW/2	200L1-2	30	125	540	4	765	290	590	1364	70	850	1200	57.5	90	417	460	18	376
XA40/32H-22KW/2	180M-2	22	125	523	4	690	273	533	1289	80	890	1100	57.5	73	387	420	18	297
XA40/32-11KW/4	160M-4	11	125	523	4	605	273	513	1204	80	890	1100	57.5	73	387	420	18	243
XA40/32-7.5KW/4	132M-4	7.5	125	523	4	510	273	486	1109	80	800	1000	57.5	73	387	420	18	210
XA40/32-5.5KW/4	132S-4	5.5	125	523	4	470	273	486	1069	80	800	1000	57.5	73	387	420	18	197
XA40/32-4KW/4	112M-4	4	125	523	4	400	273	461	999	70	700	900	57.5	73	387	420	18	177
XA40/32-3KW/4	100L2-4	3	125	523	4	385	273	443	984	80	690	900	57.5	73	387	420	18	167

Dimensions of XA Series Long Coupled Pump with Motor

Model	Motor(B3)		a	H	c	L4	H1	H2	L	L1	L2	L3	s	w	B1	B	φd	Weight (kg)
	Frame size	Power kW																
XA50/13-11KW/2	160M1-2	11	100	393	4	605	233	473	1069	70	780	1000	45	73	387	420	18	183
XA50/13-7.5KW/2	132S2-2	7.5	100	365	4	470	205	418	934	70	630	800	45	73	317	350	18	135
XA50/13-5.5KW/2	132S1-2	5.5	100	365	4	470	205	418	934	70	630	800	45	73	317	350	18	131
XA50/13-4KW/2	112M-2	4	100	352	4	400	192	380	864	80	560	750	45	60	294	330	16	99
XA50/13-3KW/2	100L-2	3	100	352	4	385	192	362	849	80	560	750	45	60	294	330	16	100
XA50/13-2.2KW/4	100L1-4	2.2	100	352	4	385	192	362	849	80	560	750	45	60	294	330	16	90
XA50/13-1.5KW/4	90L-4	1.5	100	352	4	345	192	352	809	80	560	750	45	60	294	330	16	82
XA50/13-1.1KW/4	90S-4	1.1	100	352	4	320	192	352	784	80	560	750	45	60	294	330	16	78
XA50/13-0.75KW/4	802-4	0.75	100	352	4	295	192	332	759	80	560	750	45	60	294	330	16	73
XA50/13-0.55KW/4	801-4	0.55	100	352	4	295	192	332	759	80	560	750	45	60	294	330	16	72
XA50/16-22KW/2	180M-2	22	100	433	4	690	253	513	1154	70	780	1000	32.5	73	387	420	18	241
XA50/16-18.5KW/2	160L-2	18.5	100	413	4	660	233	473	1124	70	780	7000	32.5	73	387	420	18	210
XA50/16-15KW/2	160M2-2	15	100	413	4	605	233	473	1069	70	780	1000	32.5	73	387	420	18	186
XA50/16-11KW/2	160M1-2	11	100	413	4	605	233	473	1069	70	780	1000	32.5	73	387	420	18	185
XA50/16-7.5KW/2	132S2-2	7.5	100	413	4	470	233	446	934	70	630	800	32.5	73	317	350	18	140
XA50/16-5.5KW/2	132S1-2	5.5	100	413	4	470	233	446	934	70	630	800	32.5	73	317	350	18	136
XA50/16-4KW/2	112M-2	4	100	400	4	400	220	408	864	80	560	750	32.5	60	294	330	16	104
XA50/16-3KW/4	100L2-4	3	100	400	4	385	220	390	849	80	560	750	32.5	60	294	330	16	98
XA50/16-2.2KW/4	100L1-4	2.2	100	400	4	385	220	390	849	80	560	750	32.5	60	294	330	16	95
XA50/16-1.5KW/4	90L-4	1.5	100	400	4	345	220	380	809	80	560	750	32.5	60	294	330	16	87
XA50/16-1.1KW/4	90S-4	1.1	100	400	4	320	220	380	784	80	560	750	32.5	60	294	330	16	83
XA50/16-0.75KW/4	802-4	0.75	100	400	4	295	220	360	759	80	560	750	32.5	60	294	330	16	78
XA50/16-0.55KW/4	801-4	0.55	100	400	4	295	220	360	759	80	560	750	32.5	60	294	330	16	77
XA50/20-30KW/2	200L1-2	30	100	490	4	765	290	590	1229	85	750	1100	35.5	90	417	460	18	333
XA50/20-22KW/2	180M-2	22	100	453	4	690	253	513	1154	70	780	1000	35.5	73	387	420	18	251
XA50/20-18.5KW/2	160L-2	18.5	100	433	4	660	233	473	1124	70	780	1000	35.5	73	387	420	18	220
XA50/20-15KW/2	160M2-2	15	100	433	4	605	233	473	1069	70	780	1000	35.5	73	387	420	18	196
XA50/20-11KW/2	160M1-2	11	100	433	4	605	233	473	1069	70	780	1000	35.5	73	387	420	18	195
XA50/20-7.5KW/2	132S2-2	7.5	100	433	4	470	233	446	934	70	630	800	35.5	73	317	350	18	150
XA50/20-4KW/4	112M-4	4	100	420	4	400	220	408	864	80	560	750	35.5	60	294	330	16	118
XA50/20-3KW/4	100L2-4	3	100	420	4	385	220	390	849	80	560	750	35.5	60	294	330	16	108
XA50/20-2.2KW/4	100L1-4	2.2	100	420	4	385	220	390	849	80	560	750	35.5	60	294	330	16	105
XA50/20-1.5KW/4	90L-4	1.5	100	420	4	345	220	380	809	80	560	750	35.5	60	294	330	16	97
XA50/20-1.1KW/4	90S-4	1.1	100	420	4	320	220	380	784	80	560	750	35.5	60	294	330	16	93

Dimensions of XA Series Long Coupled Pump with Motor

Model	Motor(B3)		a	H	c	L4	H1	H2	L	L1	L2	L3	s	w	B1	B	φd	Weight (kg)
	Frame size	Power kW																
XA50/26G-37KW/2	200L2-2	37	100	515	4	765	290	590	1339	85	830	1200	35.5	90	417	460	18	357
XA50/26G-30KW/2	200L1-2	30	100	515	4	765	290	590	1339	85	830	1200	35.5	90	417	460	18	347
XA50/26G-22KW/2	180M-2	22	100	478	4	690	253	513	1264	80	890	1100	35.5	73	387	420	18	268
XA50/26-37KW/2	200L2-2	37	100	515	4	765	290	590	1229	85	750	1100	35.5	90	417	460	18	360
XA50/26-30KW/2	200L1-2	30	100	515	4	765	290	590	1229	85	750	1100	35.5	90	417	460	18	350
XA50/26-22KW/2	180M-2	22	100	478	4	690	253	513	1154	70	780	1000	35.5	73	387	420	18	269
XA50/26-18.5KW/2	160L-2	18.5	100	478	4	660	253	493	1124	70	780	1000	35.5	73	387	420	18	239
XA50/26-11KW/4	160M-4	11	100	478	4	605	253	493	1069	70	780	1000	35.5	73	387	420	18	215
XA50/26-7.5KW/4	132M-4	7.5	100	478	4	510	253	466	974	70	680	900	35.5	73	387	420	18	183
XA50/26-5.5KW/4	132S-4	5.5	100	478	4	470	253	466	934	70	680	900	35.5	73	387	420	18	169
XA50/26-4KW/4	112M-4	4	100	478	4	400	253	441	864	70	630	800	35.5	73	387	420	18	143
XA50/26-3KW/4	100L2-4	3	100	478	4	385	253	423	849	70	630	800	35.5	73	387	420	18	138
XA50/32G-75KW/2	280S-2	75	125	655	6	980	375	755	1637	100	1070	1450	57.5	95	557	600	18	689
XA50/32G-55KW/2	250M-2	55	125	620	4	910	340	705	1565	110	960	1450	57.5	90	507	550	18	570
XA50/32G-45KW/2	225M-2	45	125	595	4	805	315	640	1460	110	900	1300	57.5	90	457	500	18	457
XA50/32G-37KW/2	200L2-2	37	125	595	4	765	315	615	1420	85	880	1200	57.5	90	417	460	18	398
XA50/32G-30KW/2	200L1-2	30	125	595	4	765	315	615	1420	85	880	1200	57.5	90	417	460	18	388
XA50/32H-75KW/2	280S-2	75	125	655	6	980	375	755	1581	100	1070	1450	57.5	95	557	600	18	684
XA50/32H-55KW/2	250M-2	55	125	620	4	910	340	705	1509	110	950	1300	57.5	90	507	550	18	562
XA50/32H-45KW/2	225M-2	45	125	595	4	805	315	640	1404	85	860	1200	57.5	90	457	500	18	450
XA50/32H-37KW/2	200L2-2	37	125	595	4	765	315	615	1364	85	830	1200	57.5	90	417	460	18	393
XA50/32H-30KW/2	200L1-2	30	125	595	4	765	315	615	1364	85	830	1200	57.5	90	417	460	18	383
XA50/32-18.5KW/4	180M-4	18.5	125	578	4	690	298	558	1289	80	890	1100	57.5	73	387	420	18	306
XA50/32-15KW/4	160L-4	15	125	578	4	660	298	538	1259	80	890	1100	57.5	73	387	420	18	271
XA50/32-11KW/4	160M-4	11	125	578	4	605	298	538	1204	80	890	1100	57.5	73	387	420	18	250
XA50/32-7.5KW/4	132M-4	7.5	125	578	4	510	298	511	1109	80	800	1000	57.5	73	387	420	18	217
XA50/32-5.5KW/4	132S-4	5.5	125	578	4	470	298	511	1069	80	800	1000	57.5	73	387	420	18	204
XA65/13-15KW/2	160M2-2	15	100	413	4	605	233	473	1069	70	780	1000	32.5	73	387	420	18	188
XA65/13-11KW/2	160M1-2	11	100	413	4	605	233	473	1069	70	780	1000	32.5	73	387	420	18	187
XA65/13-7.5KW/2	132S2-2	7.5	100	413	4	470	233	446	934	70	630	800	32.5	73	317	350	18	142
XA65/13-5.5KW/2	132S1-2	5.5	100	413	4	470	233	446	934	70	630	800	32.5	73	317	350	18	138
XA65/13-2.2KW/4	100L1-4	2.2	100	400	4	385	220	390	849	80	560	750	32.5	60	294	330	16	96
XA65/13-1.5KW/4	90L-4	1.5	100	400	4	345	220	380	809	80	560	750	32.5	60	294	330	16	89
XA65/13-1.1KW/4	90S-4	1.1	100	400	4	320	220	380	784	80	560	750	32.5	60	294	330	16	85

Dimensions of XA Series Long Coupled Pump with Motor

Model	Motor(B3)		a	H	c	L4	H1	H2	L	L1	L2	L3	s	w	B1	B	φd	Weight (kg)
	Frame size	Power kW																
XA65/13-0.75KW/4	802-4	0.75	100	400	4	295	220	360	759	80	560	750	32.5	60	294	330	16	80
XA65/16-30KW/2	200L1-2	30	100	490	4	765	290	590	1229	85	750	1100	20	90	417	460	18	331
XA65/16-22KW/2	180M-2	22	100	453	4	690	253	513	1154	70	780	1000	20	73	387	420	18	249
XA65/16-18.5KW/2	160L-2	18.5	100	433	4	660	233	473	1124	70	780	1000	20	73	387	420	18	218
XA65/16-15KW/2	160M2-2	15	100	433	4	605	233	473	1069	70	780	1000	20	73	387	420	18	194
XA65/16-11KW/2	160M1-2	11	100	433	4	605	233	473	1069	70	780	1000	20	73	387	420	18	193
XA65/16-7.5KW/2	132S2-2	7.5	100	433	4	470	233	446	934	70	630	800	20	73	317	350	18	148
XA65/16-5.5KW/2	132S1-2	5.5	100	433	4	470	233	446	934	70	630	800	20	73	317	350	18	144
XA65/16-4KW/4	112M-4	4	100	420	4	400	220	408	864	80	560	750	32.5	60	294	330	16	116
XA65/16-3KW/4	100L2-4	3	100	420	4	385	220	390	849	80	560	750	32.5	60	294	330	16	105
XA65/16-2.2KW/4	100L1-4	2.2	100	420	4	385	220	390	849	80	560	750	32.5	60	294	330	16	102
XA65/16-1.5KW/4	90L-4	1.5	100	420	4	345	220	380	809	80	560	750	32.5	60	294	330	16	95
XA65/16-1.1KW/4	90S-4	1.1	100	420	4	320	220	380	784	80	560	750	32.5	60	294	330	16	91
XA65/20G-37KW/2	200L2-2	37	100	515	4	765	290	590	1334	85	830	1200	37.5	90	417	460	18	354
XA65/20G-30KW/2	200L1-2	30	100	515	4	765	290	590	1334	85	830	1200	37.5	90	417	460	18	343
XA65/20-37KW/2	200L2-2	37	100	515	4	765	290	590	1229	85	750	1100	37.5	90	417	460	18	347
XA65/20-30KW/2	200L1-2	30	100	515	4	765	290	590	1229	85	750	1100	37.5	90	417	460	18	337
XA65/20-22KW/2	180M-2	22	100	478	4	690	253	513	1154	70	780	1000	37.5	73	387	420	18	256
XA65/20-18.5KW/2	160L-2	18.5	100	478	4	660	253	493	1124	70	780	1000	37.5	73	387	420	18	226
XA65/20-15KW/2	160M2-2	15	100	478	4	605	253	493	1069	70	780	1000	37.5	73	387	420	18	203
XA65/20-7.5KW/4	132M-4	7.5	100	478	4	510	253	466	974	70	680	900	37.5	73	387	420	18	170
XA65/20-5.5KW/4	132S-4	5.5	100	478	4	470	253	466	934	70	680	900	37.5	73	387	420	18	156
XA65/20-4KW/4	112M-4	4	100	478	4	400	253	441	864	70	630	800	37.5	73	387	420	18	130
XA65/20-3KW/4	100L2-4	3	100	478	4	385	253	423	849	70	630	800	37.5	73	387	420	18	120
XA65/20-2.2KW/4	100L1-4	2.2	100	478	4	385	253	423	849	70	630	800	37.5	73	387	420	18	117
XA65/26-90KW/2	280M-2	90	100	625	6	1030	375	755	1606	100	1070	1450	15	95	557	600	18	731
XA65/26-75KW/2	280S-2	75	100	625	6	980	375	755	1556	100	1070	1450	15	95	557	600	18	675
XA65/26-55KW/2	250M-2	55	100	590	4	910	340	705	1484	110	950	1300	15	90	507	550	18	554
XA65/26-45KW/2	225M-2	45	100	565	4	805	315	640	1379	85	890	1200	15	90	457	500	18	441
XA65/26-37KW/2	200L2-2	37	100	540	4	765	290	590	1339	85	830	1200	15	90	417	460	18	380
XA65/26-30KW/2	200L1-2	30	100	540	4	765	290	590	1339	85	830	1200	15	90	417	460	18	370
XA65/26-15KW/4	160L-4	15	100	523	4	660	273	513	1234	80	890	1100	15	73	387	420	18	257
XA65/26-11KW/4	160M-4	11	100	523	4	605	273	513	1179	80	890	1100	15	73	387	420	18	237
XA65/26-7.5KW/4	132M-4	7.5	100	523	4	510	273	486	1084	80	800	1000	15	73	387	420	18	204

Dimensions of XA Series Long Coupled Pump with Motor

Model	Motor(B3)		a	H	c	L4	H1	H2	L	L1	L2	L3	s	w	B1	B	φd	Weight (kg)
	Frame size	Power kW																
XA65/26-5.5KW/4	132S-4	5.5	100	523	4	470	273	486	1044	80	800	1000	15	73	387	420	18	191
XA65/26-4KW/4	112M-4	4	100	523	4	400	273	461	974	80	690	900	15	73	387	420	18	170
XA65/32G-90KW/2	280M-2	90	125	655	6	1030	375	755	1686	100	1070	1450	40	95	557	600	18	762
XA65/32G-75KW/2	280S-2	75	125	655	6	980	375	755	1636	100	1070	1450	40	95	557	600	18	706
XA65/32G-55KW/2	250M-2	55	125	620	4	910	340	705	1564	110	1010	1450	40	90	507	550	18	586
XA65/32G-45KW/2	225M-2	45	125	595	4	805	315	640	1459	110	900	1300	40	90	457	500	18	473
XA65/32H-90KW/2	280M-2	90	125	655	6	1030	375	755	1631	100	1070	1450	40	95	557	600	18	752
XA65/32H-75KW/2	280S-2	75	125	655	6	980	375	755	1581	100	1070	1450	40	95	557	600	18	696
XA65/32H-55KW/2	250M-2	55	125	620	4	910	340	705	1509	110	950	1300	40	90	507	550	18	573
XA65/32H-45KW/2	225M-2	45	125	595	4	805	315	640	1404	85	880	1200	40	90	457	500	18	462
XA65/32-22KW/4	180L-4	22	125	595	4	725	315	575	1324	85	830	1200	40	90	417	460	18	348
XA65/32-18.5KW/4	180M-4	18.5	125	595	4	690	315	575	1289	85	830	1200	40	90	417	460	18	326
XA65/32-15KW/4	160L-4	15	125	595	4	660	315	555	1259	85	900	1100	40	90	417	460	18	288
XA65/32-11KW/4	160M-4	11	125	595	4	605	315	555	1204	85	900	1100	40	90	417	460	18	267
XA65/32-7.5KW/4	132M-4	7.5	125	595	4	510	315	528	1109	85	800	1000	40	90	417	460	18	235
XA65/32-5.5KW/4	132S-4	5.5	125	595	4	470	315	528	1069	85	800	1000	40	90	417	460	18	222
XA80/16-45KW/2	225M-2	45	125	540	4	805	315	640	1294	85	750	1100	57.5	90	457	500	18	339
XA80/16-37KW/2	200L2-2	37	125	515	4	765	290	590	1254	85	750	1100	57.5	90	417	460	18	345
XA80/16-30KW/2	200L1-2	30	125	515	4	765	290	590	1254	85	750	1100	57.5	90	417	460	18	335
XA80/16-22KW/2	180M-2	22	125	478	4	690	253	513	1179	70	780	1000	57.5	73	387	420	18	254
XA80/16-18.5KW/2	160L-2	18.5	125	478	4	660	253	493	1149	70	780	1000	57.5	73	387	420	18	224
XA80/16-15KW/2	160M2-2	15	125	478	4	605	253	493	1094	70	780	1000	57.5	73	387	420	18	201
XA80/16-11KW/2	160M1-2	11	125	478	4	605	253	493	1094	70	780	1000	57.5	73	387	420	18	200
XA80/16-5.5KW/4	132S-4	5.5	125	478	4	470	253	466	959	70	680	900	57.5	73	387	420	18	154
XA80/16-4KW/4	112M-4	4	125	478	4	400	253	441	889	70	630	800	57.5	73	387	420	18	128
XA80/16-3KW/4	100L2-4	3	125	478	4	385	253	423	874	70	630	800	57.5	73	387	420	18	118
XA80/16-2.2KW/4	100L1-4	2.2	125	478	4	385	253	423	874	70	630	800	57.5	73	387	420	18	115
XA80/16-1.5KW/4	90L-4	1.5	125	478	4	345	253	413	834	70	630	800	57.5	73	387	420	18	107
XA80/20-75KW/2	280S-2	75	125	625	6	980	375	755	1581	100	1070	1450	57.5	95	557	600	18	661
XA80/20-55KW/2	250M-2	55	125	590	4	910	340	705	1509	110	950	1300	57.5	90	507	550	18	542
XA80/20-45KW/2	225M-2	45	125	565	4	805	315	640	1404	85	860	1200	57.5	90	457	500	18	431
XA80/20-37KW/2	200L2-2	37	125	540	4	765	290	590	1364	85	830	1200	57.5	90	417	460	18	368
XA80/20-30KW/2	200L1-2	30	125	540	4	765	290	590	1364	85	830	1200	57.5	90	417	460	18	358
XA80/20-22KW/2	180M-2	22	125	503	4	690	253	513	1289	80	890	1100	57.5	73	387	420	18	279

Dimensions of XA Series Long Coupled Pump with Motor

Model	Motor(B3)		a	H	c	L4	H1	H2	L	L1	L2	L3	s	w	B1	B	φd	Weight (kg)
	Frame size	Power kW																
XA80/20-11KW/4	160M-4	11	125	503	4	605	253	493	1204	80	890	1100	57.5	73	387	420	18	224
XA80/20-7.5KW/4	132M-4	7.5	125	503	4	510	253	466	1109	80	800	1000	57.5	73	387	420	18	192
XA80/20-5.5KW/4	132S-4	5.5	125	503	4	470	253	466	1069	80	800	1000	57.5	73	387	420	18	179
XA80/20-4KW/4	112M-4	4	125	503	4	400	253	441	999	80	690	900	57.5	73	387	420	18	158
XA80/20-3KW/4	100L2-4	3	125	503	4	385	253	423	984	80	690	900	57.5	73	387	420	18	148
XA80/26-132KW/2	315M-2	132	125	710	6	1290	430	945	1891	110	1050	1500	40	115	657	700	18	1175
XA80/26-110KW/2	315S-2	110	125	710	6	1180	430	940	1781	110	1050	1500	40	115	657	700	18	1094
XA80/26-90KW/2	280M-2	90	125	655	6	1030	375	755	1631	100	1070	1450	40	95	557	600	18	738
XA80/26-75KW/2	280S-2	75	125	655	6	980	375	755	1581	100	1070	1450	40	95	557	600	18	682
XA80/26-55KW/2	250M-2	55	125	620	4	910	340	705	1509	110	950	1300	40	90	507	550	18	561
XA80/26-45KW/2	225M-2	45	125	595	4	805	315	640	1404	85	860	1200	40	90	457	500	18	448
XA80/26-37KW/2	200L2-2	37	125	570	4	765	290	590	1364	85	860	1200	40	90	417	460	18	388
XA80/26-18.5KW/4	180M-4	18.5	125	553	4	690	273	533	1289	80	890	1100	40	73	417	450	18	302
XA80/26-15KW/4	160L-4	15	125	553	4	660	273	513	1259	80	890	1100	40	73	417	450	18	266
XA80/26-11KW/4	160M-4	11	125	553	4	605	273	513	1204	80	890	1100	40	73	417	450	18	246
XA80/26-7.5KW/4	132M-4	7.5	125	553	4	510	273	486	1109	80	800	1000	40	73	417	450	18	213
XA80/26-5.5KW/4	132S-4	5.5	125	553	4	470	273	486	1069	80	800	1000	40	73	417	450	18	200
XA80/26-4KW/4	112M-4	4	125	553	4	400	273	461	999	80	690	900	40	73	417	450	18	180
XA80/32G-132KW/2	315M-2	132	125	745	6	1290	430	945	1947	110	1150	1650	43	115	657	700	18	1211
XA80/32G-110KW/2	315S-2	110	125	745	6	1180	430	940	1837	110	1150	1650	43	115	657	700	18	1129
XA80/32G-90KW/2	280M-2	90	125	690	6	1030	375	755	1687	100	1070	1450	42.5	95	557	600	18	765
XA80/32G-75KW/2	280S-2	75	125	690	6	980	375	755	1637	100	1070	1450	42.5	95	557	600	18	709
XA80/32H-132KW/2	315M-2	132	125	745	6	1290	430	945	1891	110	1100	1500	42.5	115	657	700	18	1192
XA80/32H-110KW/2	315S-2	110	125	745	6	1180	430	940	1781	110	1100	1500	42.5	115	657	700	18	1110
XA80/32H-90KW/2	280M-2	90	125	690	6	1030	375	755	1631	100	1070	1450	42.5	95	557	600	18	747
XA80/32H-75KW/2	280S-2	75	125	690	6	980	375	755	1581	100	1070	1450	42.5	95	557	600	18	691
XA80/32-37KW/4	225S-4	37	125	655	4	810	340	670	1409	110	900	1300	42.5	90	457	500	18	499
XA80/32-30KW/4	200L-4	30	125	655	4	765	340	640	1364	85	850	1200	42.5	90	417	460	18	414
XA80/32-22KW/4	180L-4	22	125	655	4	725	340	600	1324	85	830	1200	42.5	90	417	460	18	353
XA80/32-18.5KW/4	180M-4	18.5	125	655	4	690	340	600	1289	85	830	1200	42.5	90	417	460	18	331
XA80/32-15KW/4	160L-4	15	125	655	4	660	340	580	1259	85	900	1100	42.5	90	417	460	18	293
XA80/32-11KW/4	160M-4	11	125	655	4	605	340	580	1204	85	900	1100	42.5	90	417	460	18	272
XA80/32-7.5KW/4	132M-4	7.5	125	655	4	510	340	553	1109	85	800	1000	42.5	90	417	460	18	240
XA80/40-55KW/4	250M-4	55	125	725	4	910	370	735	1569	110	1010	1450	40	90	507	550	18	635

Dimensions of XA Series Long Coupled Pump with Motor

Model	Motor(B3)		a	H	c	L4	H1	H2	L	L1	L2	L3	s	w	B1	B	φd	Weight (kg)
	Frame size	Power kW																
XA80/40-45KW/4	225M-4	45	125	725	4	835	370	695	1494	110	950	1300	40	90	457	500	18	557
XA80/40-37KW/4	225S-4	37	125	725	4	810	370	700	1469	110	950	1300	40	90	457	500	18	546
XA80/40-30KW/4	200L-4	30	125	725	4	765	370	670	1424	110	900	1300	40	90	457	500	18	464
XA80/40-22KW/4	180L-4	22	125	725	4	725	370	630	1384	85	870	1200	40	90	457	500	18	401
XA80/40-18.5KW/4	180M-4	18.5	125	725	4	690	370	630	1349	85	870	1200	40	90	457	500	18	380
XA80/40-15KW/4	160L-4	15	125	725	4	660	370	610	1319	85	860	1200	40	90	457	500	18	351
XA100/16-45KW/2	225M-2	45	125	565	4	805	315	640	1404	85	890	1200	49	90	457	500	18	441
XA100/16-37KW/2	200L2-2	37	125	540	4	765	290	590	1364	85	830	1200	49	90	417	460	18	380
XA100/16-30KW/2	200L1-2	30	125	540	4	765	290	590	1364	85	830	1200	49	90	417	460	18	370
XA100/16-22KW/2	180M-2	22	125	523	4	690	273	533	1289	80	890	1100	49	73	387	420	18	291
XA100/16-18.5KW/2	160L-2	18.5	125	523	4	660	273	513	1259	80	890	1100	49	73	387	420	18	261
XA100/16-15KW/2	160M2-2	15	125	523	4	605	273	513	1204	80	890	1100	49	73	387	420	18	238
XA100/16-7.5KW/4	132M-4	7.5	125	523	4	510	273	486	1109	80	800	1000	49	73	387	420	18	204
XA100/16-5.5KW/4	132S-4	5.5	125	523	4	470	273	486	1069	80	800	1000	49	73	387	420	18	191
XA100/16-4KW/4	112M-4	4	125	523	4	400	273	461	999	80	690	900	49	73	387	420	18	170
XA100/16-3KW/4	100L2-4	3	125	523	4	385	273	443	984	80	690	900	49	73	387	420	18	160
XA100/16-2.2KW/4	100L1-4	2.2	125	523	4	385	273	443	984	80	690	900	49	73	387	420	18	157
XA100/20-110KW/2	315S-2	110	125	710	6	1180	430	940	1781	110	1050	1500	40	115	657	700	18	1084
XA100/20-90KW/2	280M-2	90	125	655	6	1030	375	755	1631	100	1070	1450	40	95	557	600	18	728
XA100/20-75KW/2	280S-2	75	125	655	6	980	375	755	1581	100	1070	1450	40	95	557	600	18	672
XA100/20-55KW/2	250M-2	55	125	620	4	910	340	705	1509	110	950	1300	40	90	507	550	18	551
XA100/20-45KW/2	225M-2	45	125	595	4	805	315	640	1404	85	890	1200	40	90	457	500	18	438
XA100/20-37KW/2	200L2-2	37	125	570	4	765	290	590	1364	85	830	1200	40	90	417	460	18	377
XA100/20-30KW/2	200L1-2	30	125	570	4	765	290	590	1364	85	830	1200	40	90	417	460	18	367
XA100/20-15KW/4	160L-4	15	125	553	4	660	273	513	1259	80	890	1100	40	73	387	420	18	254
XA100/20-11KW/4	160M-4	11	125	553	4	605	273	513	1204	80	890	1100	40	73	387	420	18	234
XA100/20-7.5KW/4	132M-4	7.5	125	553	4	510	273	486	1109	80	800	1000	40	73	387	420	18	201
XA100/20-5.5KW/4	132S-4	5.5	125	553	4	470	273	486	1069	80	800	1000	40	73	387	420	18	188
XA100/20-4KW/4	112M-4	4	125	553	4	400	273	461	999	80	690	900	40	73	387	420	18	167
XA100/20-3KW/4	100L2-4	4	125	553	4	385	273	443	984	80	690	900	40	73	387	420	18	157
XA100/26-132KW/2	315M-2	132	140	710	6	1290	430	945	1906	110	1050	1500	55	115	657	700	18	1181
XA100/26H-110KW/2	315S-2	110	140	710	6	1180	430	940	1796	110	1050	1500	55	115	657	700	18	1100
XA100/26H-90KW/2	280M-2	90	140	655	6	1030	375	755	1646	100	1070	1450	55	95	557	600	18	744
XA100/26H-75KW/2	280S-2	75	140	655	6	980	375	755	1596	100	1070	1450	55	95	557	600	18	688

Dimensions of XA Series Long Coupled Pump with Motor

Model	Motor(B3)		a	H	c	L4	H1	H2	L	L1	L2	L3	s	w	B1	B	φd	Weight (kg)
	Frame size	Power kW																
XA100/26H-55KW/2	250M-2	55	140	620	4	910	340	705	1524	110	950	1300	55	90	507	550	18	565
XA100/26-30KW/4	200L-4	30	140	595	4	765	315	615	1379	85	870	1200	55	90	417	460	18	401
XA100/26-22KW/4	180L-4	22	140	595	4	725	315	575	1339	85	830	1200	55	90	417	460	18	340
XA100/26-18.5KW/4	180M-4	18.5	140	595	4	690	315	575	1304	85	830	1200	55	90	417	460	18	318
XA100/26-15KW/4	160L-4	15	140	595	4	660	315	555	1274	85	900	1100	55	90	417	460	18	280
XA100/26-11KW/4	160M-4	11	140	595	4	605	315	555	1219	85	900	1100	55	90	417	460	18	259
XA100/26-7.5KW/4	132M-4	7.5	140	595	4	510	315	528	1124	85	800	1000	55	90	417	460	18	227
XA100/32-45KW/4	225M-4	45	140	655	4	835	340	665	1449	110	900	1300	57.5	90	457	500	18	514
XA100/32-37KW/4	225S-4	37	140	655	4	810	340	670	1424	110	900	1300	57.5	90	457	500	18	503
XA100/32-30KW/4	200L-4	30	140	655	4	765	340	640	1379	85	850	1200	57.5	90	417	460	18	418
XA100/32-22KW/4	180L-4	22	140	655	4	725	340	600	1339	85	830	1200	57.5	90	417	460	18	357
XA100/32-18.5KW/4	180M-4	18.5	140	655	4	690	340	600	1304	85	830	1200	57.5	90	417	460	18	335
XA100/32-15KW/4	160L-4	15	140	655	4	660	340	580	1274	85	900	1100	57.5	90	417	460	18	297
XA100/32-11KW/4	160M-4	11	140	655	4	605	340	580	1219	85	900	1100	57.5	90	417	460	18	276
XA100/40-75KW/4	280S-4	75	140	730	6	980	375	755	1656	100	1070	1450	35	95	557	600	18	827
XA100/40-55KW/4	250M-4	55	140	725	4	910	370	735	1584	110	1010	1450	35	90	507	550	18	650
XA100/40-45KW/4	225M-4	45	140	725	4	835	370	695	1509	110	950	1300	35	90	507	550	18	577
XA100/40-37KW/4	225S-4	37	140	725	4	810	370	700	1484	110	950	1300	35	90	507	550	18	565
XA100/40-30KW/4	200L-4	30	140	725	4	765	370	670	1439	110	900	1300	35	90	507	550	18	483
XA100/40-22KW/4	180L-4	22	140	725	4	725	370	630	1399	110	900	1300	35	90	507	550	18	422
XA125/20-75KW/2	280S-2	75	140	690	6	980	375	755	1596	100	1070	1450	62.5	95	557	600	18	689
XA125/20-55KW/2	250M-2	55	140	655	4	910	340	705	1524	110	950	1300	62.5	90	507	550	18	575
XA125/20-45KW/2	225M-2	45	140	655	4	805	340	665	1419	110	860	1300	62.5	90	457	500	18	468
XA125/20-18.5KW/4	180M-4	18.5	140	655	4	690	340	600	1304	85	830	1200	62.5	90	417	460	18	329
XA125/20-15KW/4	160L-4	15	140	655	4	660	340	580	1274	85	900	1100	62.5	90	417	460	18	291
XA125/20-11KW/4	160M-4	11	140	655	4	605	340	580	1219	85	900	1100	62.5	90	417	460	18	270
XA125/20-7.5KW/4	132M-4	7.5	140	655	4	510	340	553	1124	85	800	1000	62.5	90	417	460	18	238
XA125/20-5.5KW/4	132S-4	5.5	140	655	4	470	340	553	1084	85	800	1000	62.5	90	417	460	18	225
XA125/26-37KW/4	225S-4	37	140	695	4	810	340	670	1424	110	900	1300	57.5	90	457	500	18	502
XA125/26-30KW/4	200L-4	30	140	695	4	765	340	640	1379	85	850	1200	57.5	90	417	460	18	417
XA125/26-22KW/4	180L-4	22	140	695	4	725	340	600	1339	85	830	1200	57.5	90	417	460	18	356
XA125/26-18.5KW/4	180M-4	18.5	140	695	4	690	340	600	1304	85	830	1200	57.5	90	417	460	18	334
XA125/26-15KW/4	160L-4	15	140	695	4	660	340	580	1274	85	900	1100	57.5	90	417	460	18	296
XA125/26-11KW/4	160M-4	11	140	695	4	605	340	580	1219	85	900	1100	57.5	90	417	460	18	275

Dimensions of XA Series Long Coupled Pump with Motor

Model	Motor(B3)		a	H	c	L4	H1	H2	L	L1	L2	L3	s	w	B1	B	φd	Weight (kg)
	Frame size	Power kW																
XA125/32-55KW/4	250M-4	55	140	725	4	910	370	735	1584	110	1010	1450	35	90	507	550	18	629
XA125/32-45KW/4	225M-4	45	140	725	4	835	370	695	1509	110	950	1300	35	90	507	550	18	556
XA125/32-37KW/4	225S-4	37	140	725	4	810	370	700	1484	110	950	1300	35	90	507	550	18	544
XA125/32-30KW/4	200L-4	30	140	725	4	765	370	670	1439	110	900	1300	35	90	507	550	18	462
XA125/32-22KW/4	180L-4	22	140	725	4	725	370	630	1399	110	900	1300	35	90	507	550	18	401
XA125/32-18.5KW/4	180M-4	18.5	140	725	4	690	370	630	1364	110	900	1300	35	90	507	550	18	379
XA125/32-15KW/4	160L-4	15	140	725	4	660	370	610	1334	85	860	1200	35	90	507	550	18	341
XA125/40-110KW/4	315S-4	110	180	830	6	1275	430	940	1991	110	1150	1650	55	115	657	700	18	1153
XA125/40-90KW/4	280M-4	90	180	810	6	1030	410	790	1746	100	1070	1450	55	95	557	600	18	872
XA125/40-75KW/4	280S-4	75	180	810	6	980	410	790	1696	100	1070	1452	55	95	557	600	18	830
XA125/40-55KW/4	250M-4	55	180	805	4	910	405	770	1624	110	1010	1450	55	90	507	550	18	655
XA125/40-45KW/4	225M-4	45	180	805	4	835	405	730	1549	110	950	1300	55	90	507	550	18	580
XA125/40-37KW/4	225S-4	37	180	805	4	810	405	735	1524	110	950	1300	55	90	507	550	18	569
XA125/40-30KW/4	200L-4	30	180	805	4	765	405	705	1479	110	900	1300	55	90	507	550	18	486
XA125/50-160KW/4	315L1-4	160	180	920	6	1320	470	985	2176	110	1350	1850	55	115	657	700	18	1466
XA125/50-132KW/4	315M-4	132	180	920	6	1320	470	985	2176	110	1300	1750	55	115	657	700	18	1420
XA125/50-110KW/4	315S-4	110	180	920	6	1275	470	980	2131	110	1300	1750	55	115	657	700	18	1278
XA125/50-90KW/4	280M-4	90	180	920	6	1030	470	850	1886	110	1200	1650	55	115	657	700	18	1026
XA125/50-75KW/4	280S-4	75	180	920	6	980	470	850	1836	110	1200	1650	55	115	657	700	18	983
XA150/20-30KW/4	200L-4	30	180	770	4	765	370	670	1449	105	890	1300	55	90	417	460	18	434
XA150/20-22KW/4	180L-4	22	180	770	4	725	370	630	1409	105	840	1200	55	90	417	460	18	372
XA150/20-18.5KW/4	180M-4	18.5	180	770	4	690	370	630	1374	105	840	1200	55	90	417	460	18	350
XA150/20-15KW/4	160L-4	15	180	770	4	660	370	610	1344	105	820	1200	55	90	417	460	18	313
XA150/20-11KW/4	160M-4	11	180	770	4	605	370	610	1289	105	820	1200	55	90	417	460	18	293
XA150/26-55KW/4	250M-4	55	180	695	4	910	340	705	1624	110	1010	1450	55	90	507	550	18	637
XA150/26-45KW/4	225M-4	45	180	695	4	835	340	665	1549	110	950	1300	55	90	457	500	18	561
XA150/26-37KW/4	225S-4	37	180	695	4	810	340	670	1524	110	950	1300	55	90	457	500	18	549
XA150/26-30KW/4	200L-4	30	180	695	4	765	340	640	1479	110	900	1300	55	90	457	500	18	467
XA150/26-22KW/4	180L-4	22	180	695	4	725	340	600	1439	85	870	1200	55	90	457	500	18	404
XA150/26-18.5KW/4	180M-4	18.5	180	695	4	690	340	600	1404	85	870	1200	55	90	457	500	18	383
XA150/26-15KW/4	160L-4	15	180	695	4	660	340	580	1374	85	880	1200	55	90	457	500	18	346
XA150/32-90KW/4	280M-4	90	180	775	6	1030	375	755	1746	100	1070	1450	60	95	557	600	18	864
XA150/32-75KW/4	280S-4	75	180	775	6	980	375	755	1696	100	1070	1450	60	95	557	600	18	822
XA150/32-55KW/4	250M-4	55	180	770	4	910	370	735	1624	110	1010	1450	60	90	557	600	18	648

Dimensions of XA Series Long Coupled Pump with Motor

Model	Motor(B3)		a	H	c	L4	H1	H2	L	L1	L2	L3	s	w	B1	B	φd	Weight (kg)
	Frame size	Power kW																
XA150/32-45KW/4	225M-4	45	180	770	4	835	370	695	1549	110	950	1450	60	90	557	600	18	575
XA150/32-37KW/4	225S-4	37	180	770	4	810	370	700	1524	110	950	1450	60	90	557	600	18	564
XA150/32-30KW/4	200L-4	30	180	770	4	765	370	670	1479	110	900	1300	60	90	557	600	18	479
XA150/32-22KW/4	180L-4	22	180	770	4	725	370	630	1439	110	900	1300	60	90	557	600	18	418
XA150/40-132KW/4	315M-4	132	180	880	6	1320	430	945	2036	110	1150	1650	55	115	657	700	18	1323
XA150/40-110KW/4	315S-4	110	180	880	6	1275	430	940	1991	110	1150	1650	55	115	657	700	18	1180
XA150/40-90KW/4	280M-4	90	180	880	6	1030	430	810	1746	110	1080	1500	55	115	657	700	18	921
XA150/40-75KW/4	280S-4	75	180	880	6	980	430	810	1696	110	1080	1500	55	115	657	700	18	878
XA150/40-55KW/4	250M-4	55	180	875	4	910	425	790	1624	110	990	1400	55	110	557	600	18	696
XA150/40-45KW/4	225M-4	45	180	875	4	835	425	750	1549	110	990	1400	55	110	557	600	18	625
XA150/40-37KW/4	225S-4	37	180	875	4	810	425	755	1524	110	990	1400	55	110	557	600	18	619
XA150/50-200KW/4	315L2-4	200	180	990	6	1320	490	1005	2176	110	1350	1850	75	115	657	700	18	1579
XA150/50-160KW/4	315L1-4	160	180	990	6	1320	490	1005	2176	110	1350	1850	75	115	657	700	18	1497
XA150/50-132KW/4	315M-4	132	180	990	6	1320	490	1005	2176	110	1300	1750	75	115	657	700	18	1452
XA150/50-110KW/4	315S-4	110	180	990	6	1275	490	1000	2131	110	1300	1750	75	115	657	700	18	1309
XA150/50-90KW/4	280M-4	90	180	990	6	1030	490	870	1886	110	1200	1650	75	115	657	700	18	1056
XA200/26-55KW/4	250M-4	55	180	875	4	910	425	790	1649	110	990	1400	75	110	557	600	18	708
XA200/26-45KW/4	225M-4	45	180	875	4	835	425	750	1574	110	990	1400	75	110	557	600	18	635
XA200/26-37KW/4	225S-4	37	180	875	4	810	425	755	1549	110	990	1400	75	110	557	600	18	624
XA200/26-30KW/4	200L-4	30	180	875	4	765	425	725	1504	110	940	1300	75	110	557	600	18	539
XA200/26-22KW/4	180L-4	22	180	875	4	725	425	685	1464	110	940	1300	75	110	557	600	18	478
XA200/26-18.5KW/4	180M-4	18.5	180	875	4	690	425	685	1429	110	940	1300	75	110	557	600	18	457
XA200/32-110KW/4	315S-4	110	180	910	6	1275	430	940	2131	110	1300	1750	50	115	657	700	18	1263
XA200/32-90KW/4	280M-4	90	180	910	6	1030	430	810	1886	130	1210	1650	50	115	657	700	18	1005
XA200/32-75KW/4	280S-4	75	180	910	6	980	430	810	1836	130	1210	1650	50	115	657	700	18	962
XA200/32-55KW/4	250M-4	55	180	905	4	910	425	790	1764	130	1170	1600	50	110	607	650	18	784
XA200/32-45KW/4	225M-4	45	180	905	4	835	425	750	1689	130	1070	1500	50	110	607	650	18	709
XA200/32-37KW/4	225S-4	37	180	905	4	810	425	755	1664	130	1070	1500	50	110	607	650	18	698
XA200/32-30KW/4	200L-4	30	180	905	4	765	425	725	1619	130	1070	1500	50	110	607	650	18	614
XA200/40-200KW/4	315L2-4	200	180	930	6	1320	450	965	2176	130	1330	1850	50	115	657	700	18	1576
XA200/40-160KW/4	315L1-4	160	180	930	6	1320	450	965	2176	130	1330	1850	50	115	657	700	18	1494
XA200/40-132KW/4	315M-4	132	180	930	6	1320	450	965	2176	110	1300	1750	35	115	657	700	18	1449
XA200/40-110KW/4	315S-4	110	180	930	6	1275	450	960	2131	110	1300	1750	35	115	657	700	18	1306

Dimensions of XA Series Long Coupled Pump with Motor

Model	Motor(B3)		a	H	c	L4	H1	H2	L	L1	L2	L3	s	w	B1	B	φd	Weight (kg)
	Frame size	Power kW																
XA200/40-90KW/4	280M-4	90	180	930	6	1030	450	830	1886	130	1210	1650	35	115	657	700	18	1047
XA200/40-75KW/4	280S-4	75	180	930	6	980	450	830	1836	130	1210	1650	35	115	657	700	18	1004
XA200/40-55KW/4	250M-4	55	180	925	4	910	445	810	1764	130	1170	1600	50	110	607	650	18	827
XA200/50-315KW/4	355L-4	315	200	1140	6	1540	580	1235	2466	110	1510	2100	95	155	800	850	18	2457
XA200/50-250KW/4	355M-4	250	200	1140	6	1540	580	1235	2466	110	1510	2000	95	155	800	850	18	2303
XA200/50-200KW/4	315L2-4	200	200	1100	6	1320	540	1055	2246	110	1420	1850	95	115	807	850	18	1710
XA200/50-160KW/4	315L1-4	160	200	1100	6	1320	540	1055	2246	110	1420	1850	95	115	807	850	18	1628
XA200/50-132KW/4	315M-4	132	200	1100	6	1320	540	1055	2246	110	1370	1750	95	115	807	850	18	1585
XA200/50-110KW/4	315S-4	110	200	1100	6	1275	540	1050	2201	110	1370	1750	95	115	807	850	18	1442
XA250/32-160KW/4	315L1-4	160	220	990	6	1320	470	985	2237	110	1300	1850	90	115	657	700	18	1535
XA250/32-132KW/4	315M-4	132	220	990	6	1320	470	985	2237	110	1300	1850	90	115	657	700	18	1491
XA250/32-110KW/4	315S-4	110	220	990	6	1275	470	980	2192	110	1300	1850	90	115	657	700	18	1348
XA250/32-90KW/4	280M-4	90	220	990	6	1030	470	850	1947	130	1250	1650	90	115	657	700	18	1089
XA250/32-75KW/4	280S-4	75	220	990	6	980	470	850	1897	130	1250	1650	90	115	657	700	18	1046
XA250/32-55KW/4	250M-4	55	220	985	6	910	465	830	1827	130	1200	1650	90	110	657	700	18	871
XA250/32-45KW/4	225M-4	45	220	985	6	835	465	790	1752	130	1170	1500	90	110	657	700	18	795
XA250/32-37KW/4	225S-4	37	220	985	6	810	465	795	1727	130	1170	1500	90	110	657	700	18	783
XA250/40-250KW/4	355M-4	250	220	1115	6	1540	555	1210	2448	130	1370	2000	90	155	800	850	18	2251
XA250/40-200KW/4	315L2-4	200	220	1075	6	1320	515	1030	2228	130	1350	1850	90	115	657	700	18	1649
XA250/40-160KW/4	315L1-4	160	220	1075	6	1320	515	1030	2228	130	1350	1850	90	115	657	700	18	1567
XA250/40-132KW/4	315M-4	132	220	1075	6	1320	515	1030	2228	110	1300	1850	90	115	657	700	18	1524
XA250/40-110KW/4	315S-4	110	220	1075	6	1275	515	1025	2183	110	1300	1850	90	115	657	700	18	1381
XA250/40-90KW/4	280M-4	90	220	1075	6	1030	515	895	1938	130	1250	1650	90	115	657	700	18	1121
XA250/40-75KW/4	280S-4	75	220	1075	6	980	515	895	1888	130	1250	1650	90	115	657	700	18	1078
XA250/50-315KW/4	355L-4	315	250	1275	6	1540	605	1260	2516	110	1450	2100	95	155	800	850	18	2561
XA250/50-250KW/4	355M-4	250	250	1275	6	1540	605	1260	2516	110	1510	2000	95	155	800	850	18	2406
XA250/50-200KW/4	315L2-4	200	250	1235	6	1320	565	1080	2296	130	1400	1850	125	115	807	850	18	1811
XA250/50-160KW/4	315L1-4	160	250	1235	6	1320	565	1080	2296	130	1400	1850	125	115	807	850	18	1730
XA250/50-132KW/4	315M-4	132	250	1235	6	1320	565	1080	2296	130	1400	1850	125	115	807	850	18	1686
XA300/40-200KW/4	315L2-4	200	300	965	6	1320	540	1055	2346	130	1400	1850	170	115	807	850	18	1810
XA300/40-160KW/4	315L1-4	160	300	965	6	1320	540	1055	2346	130	1400	1850	172	115	807	850	18	1728
XA300/40-132KW/4	315M-4	132	300	965	6	1320	540	1055	2346	130	1400	1850	170	115	807	850	18	1685
XA300/40-110KW/4	315S-4	110	300	965	6	1275	540	1050	2301	130	1400	1850	170	115	807	850	18	1542
XA300/40-90KW/4	280M-4	90	300	965	6	1030	540	920	2056	130	1300	1750	170	115	807	850	18	1283

HSF

Stainless Steel Sea Water Pump



Description

HSF series centrifugal stainless steel sea water pumps are optimized and designed according to the unique structure combination of ISW centrifugal pump and vertical pump, adopting domestic advanced water conservancy model. All the flow passage components are made of 304 stainless steel, which has excellent corrosion resistance, and is especially suitable for pumping liquids with strong corrosive media such as seawater and chemicals.

Main Features

- Insulation class: F
- Mechanical seal: Carbide resistant to corrosion and wear
- Flow passage components: Cast stainless steel 304
- Motor shaft: 304 stainless steel welding

Using condition and Application

Main Application

- Desalination
- Mariculture
- Chemical、Pharmaceutical
- Industrial Sewage
- Sewage Treatment

This series water pump can run continuously and normally under the following environmental conditions

- 380V 50Hz AC power supply, the frequency and voltage fluctuations meet the national grid standards ;
- Working environment temperature is 0-40°C , conveying medium temperature doesn't exceed +40°C , and relative humidity 95%, volume content of solid particles in the medium doesn't exceed 0.1% of the unit volume, Particle size <0.2mm ; medium doesn't exceed 0.1% of the unit volume, Particle size <0.2mm ;
- PH value of the conveying medium is between 4-10, and specific gravity of the medium is not more than 1.05 ;
- Below 1000m above sea level ;
- Suction pressure ≤ 1.0Mpa, the maximum working pressure of the system ≤ 1.6Mpa ;

Technical Parameter/Installation Dimension

Model	Power		Voltage	Rated Flow	Rated Head	Max Flow	Max Head	DN
	KW	HP	V	m³/h	m	m³/h	m	Inch/mm
100HSF25-15-1.5(D)	1.5	2	220/380	25	15	65	17	4"/100
100HSF40-15-2.2(D)	2.2	3	220/380	40	15	75	19	4"/100
100HSF50-15-3	3	4	380	50	15	80	22	4"/100
100HSF50-18-4	4	5.5	380	50	18	85	25	4"/100
100HSF60-20-5.5	5.5	7.5	380	60	20	90	26	4"/100
100HSF70-25-7.5	7.5	10	380	70	25	100	30	4"/100
150HSF60-13.5-4	4	5.5	380	60	13.5	120	18	6"/150
150HSF80-16-5.5	5.5	7.5	380	80	16	130	22	6"/150
150HSF90-18-7.5	7.5	10	380	90	18	140	27	6"/150
150HSF120-22-11	11	15	380	120	22	160	33.5	6"/150
100HSF50-18-3(I)	3	4	380	50	18	85	25	4"/100
100HSF60-20-4(I)	4	5.5	380	60	20	100	26	4"/100
100HSF70-25-5.5(I)	5.5	7.5	380	70	25	100	32	4"/100
150HSF80-15-4(I)	4	5.5	380	80	15	120	23	6"/150
150HSF100-18-5.5(I)	5.5	7.5	380	100	18	130	28	6"/150
150HSF120-20-7.5(I)	7.5	10	380	120	20	150	30	6"/150
150HSF90-18-7.5	380	7.5	90	18	140	27	150	216
150HSF120-22-11	380	11	120	22	160	33.5	150	254

CA(B)/CAG(B)

Stainless Steel Centrifugal Pump



Civil use



Industrial use



Application

- Industrial pressurization
- Water supply system
- Boiler feed water and condensing system
- Condensing system
- Cooling and air conditioning system
- Water treatment

Operation Conditions

- Liquid: thin, clean, non-flammable and explosive liquids without solid particles or fibers; industrial liquids such as weak acid and alkali.
- Liquid temperature: Low temperature: -20°C to $+70^{\circ}\text{C}$
Normal temperature: $+15^{\circ}\text{C}$ to $+70^{\circ}\text{C}$
High temperature: $+70^{\circ}\text{C}$ to 104°C
- PH value: between 6.5–8.5
- Ambient temperature: $\leq 40^{\circ}\text{C}$
- Altitude: $\leq 1000\text{m}$
- Max. working pressure: 1.0Mpa
- Voltage fluctuation range: $\pm 10\%$
- Before use, it must be filled with water to drain the air in the pump, otherwise the water cannot be pumped normally

Motor

- Voltage & Frequency: single-phase 220–240V/50Hz, three-phase 380–415V/50Hz (60Hz and different voltages can be customized).
- Motor poles: 2 poles
- Insulation class: F
- Protection class: IP55
- Working system: S1
- Built-in thermal protector for single-phase motor
- Bearing: C&U high temperature bearing
- Max. times of motor starts per hour: 20 times; motor starts times(lifetime): $\geq 100,000$ times.

Model Implication

CA G B 100 – 80 – 200 / 30 D – 4

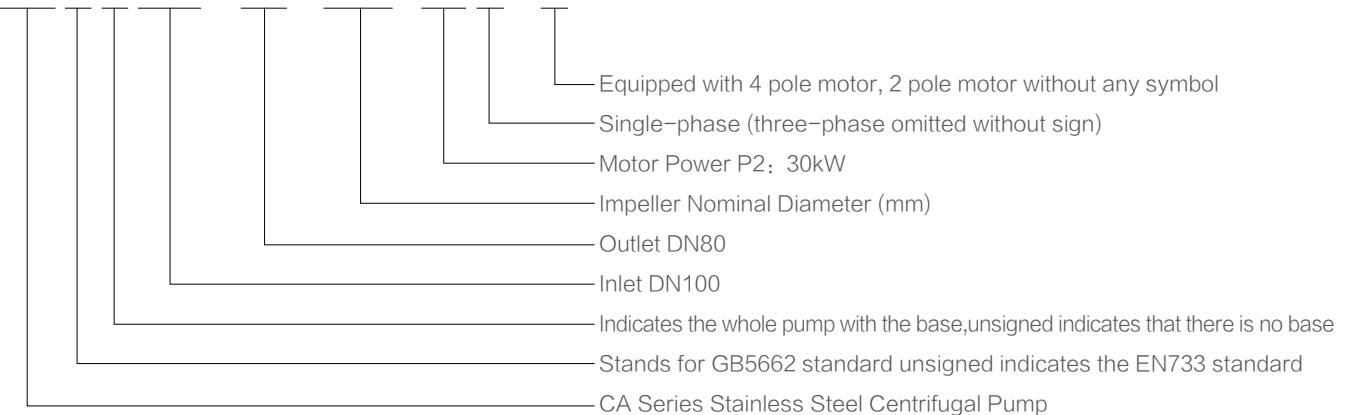

Product Frame Size

No.	Power (KW)	Frame Size	Remark
1	1.1	80	Aluminum Alloy Frame
2	1.5	80	
3	2.2	90	
4	3	90	
5	4	100L	
6	5.5	112M	
7	7.5	112M	
8	9.2	132S	Aluminum Alloy Frame
9	11	132S	
10	15	132S	
11	18.5	160L	Cast Iron Frame
12	22	160L	
13	30	200M	
14	37	200M	
15	45	225M	
16	55	250M	
17	75	280S	
18	90	280S	

Structure

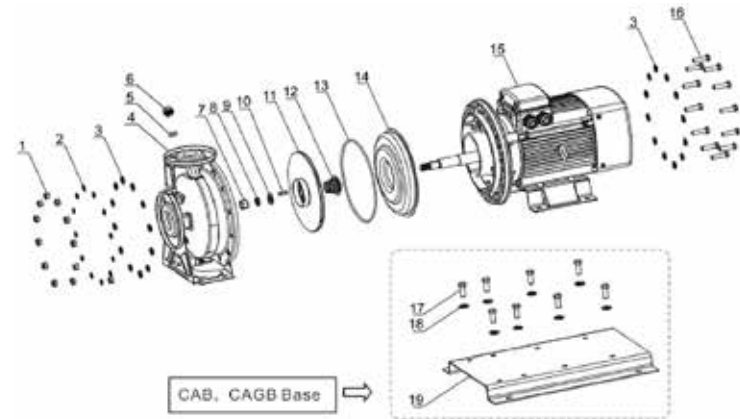

No.	Part	Material	No.	Part	Material
1	Hexagonal Nut	SUS304	11	Impeller	SUS304
2	Spring Washer	SUS304	12	Mechanical Seal	Graphite/Silicon Carbide/NBR
3	Flat Washer	SUS304	13	O Ring	NBR
4	Pump Housing	SUS304	14	Pump Cover	SUS304
5	Screw Plug O Ring	NBR	15	Motor	
6	Plug	SUS304	16	Hexagonal Bolt	SUS304
7	Impeller Nut	SUS304	17	Base Bolt	A3
8	Spring Washer	SUS304	18	Flat Washer	A3
9	Flat Washer	SUS304	19	Base	A3/Channel Steel
10	Flat Key	SUS304			

Scope of Performance

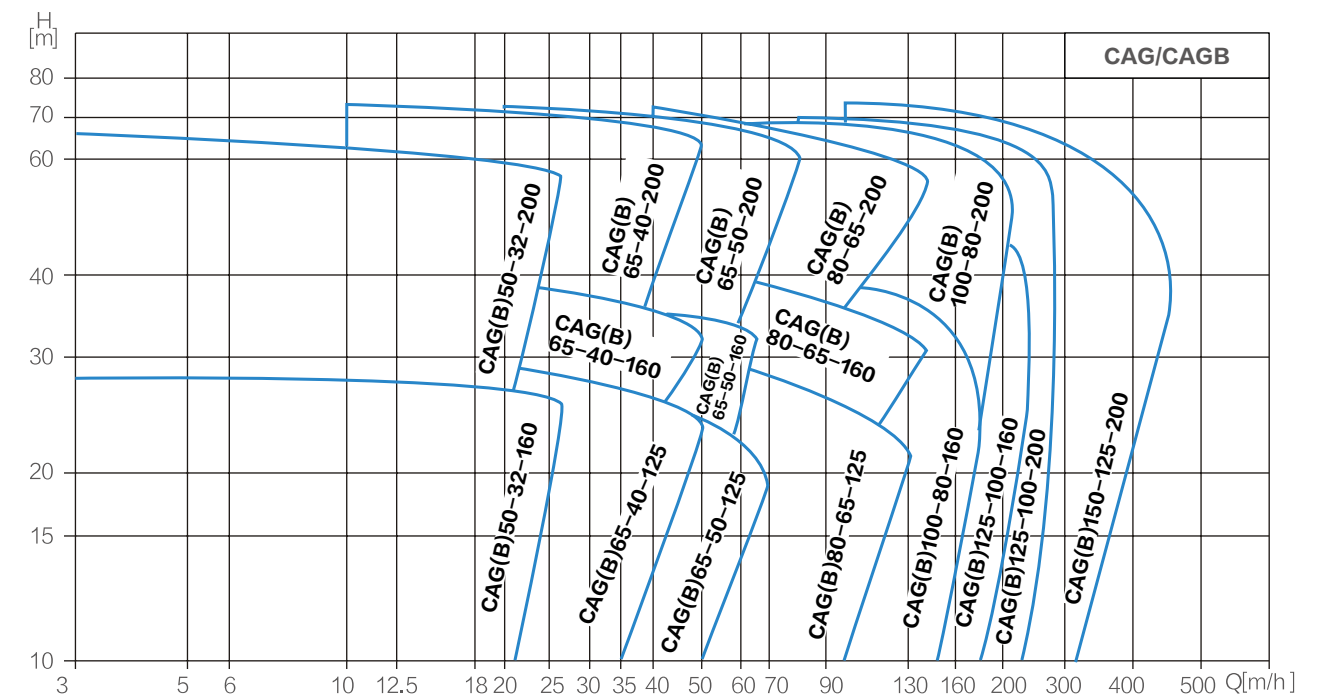
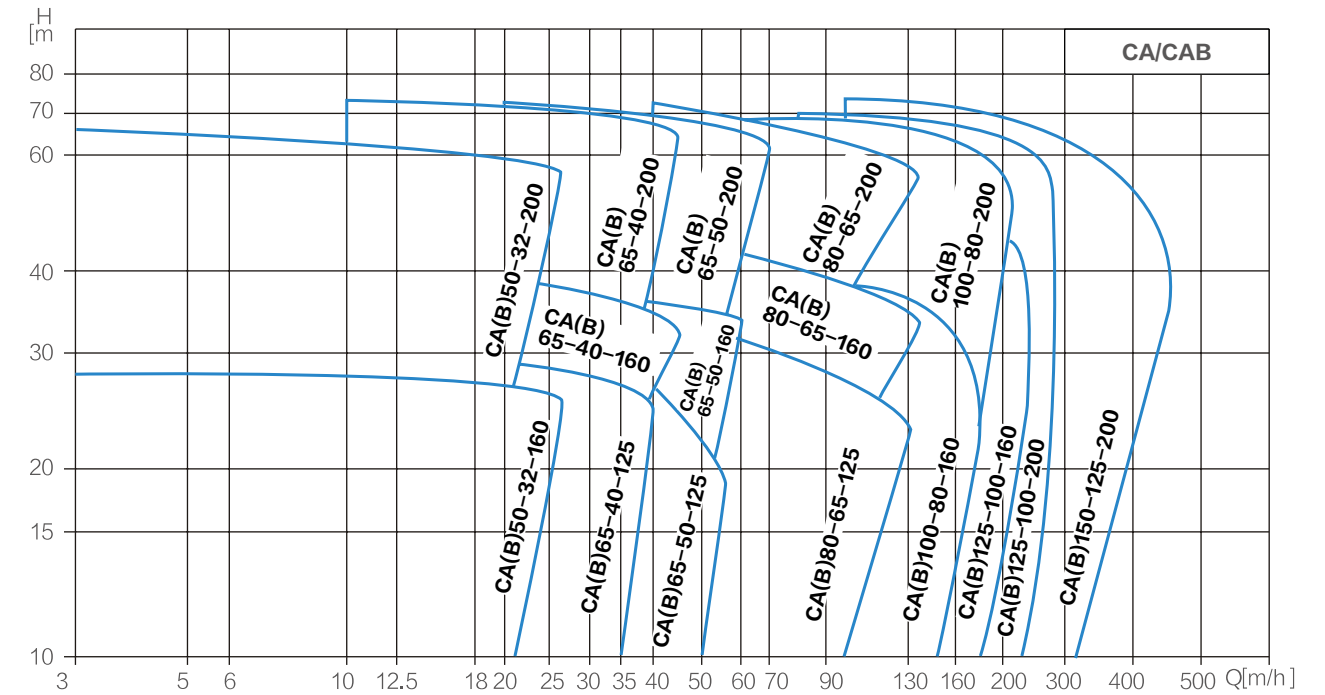

Hydraulic Performance Curves

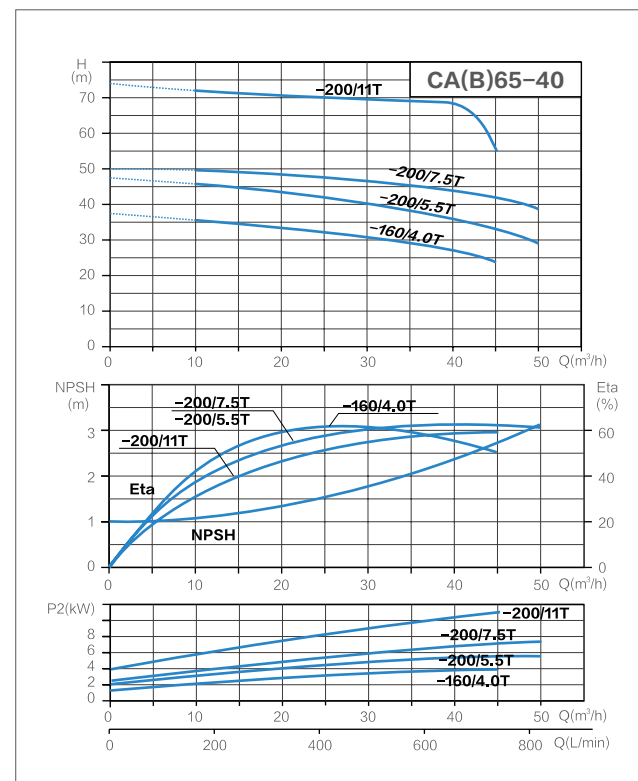
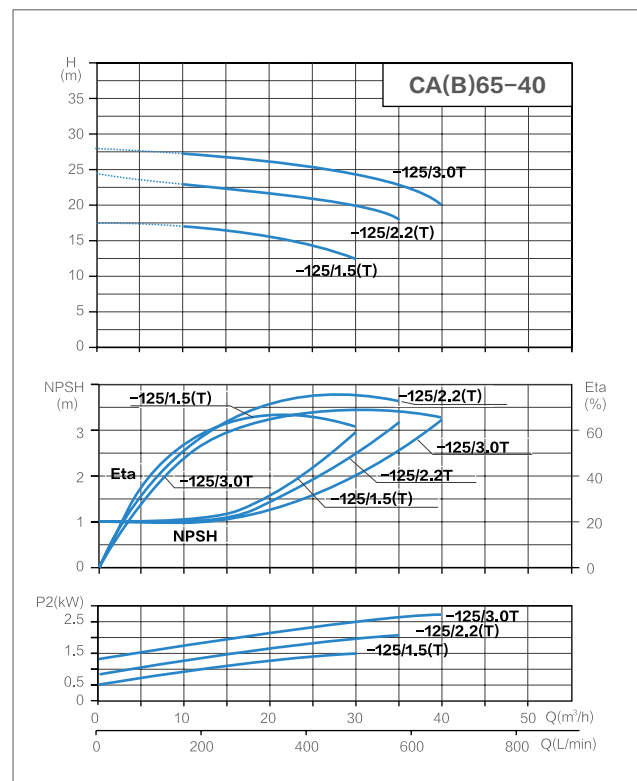
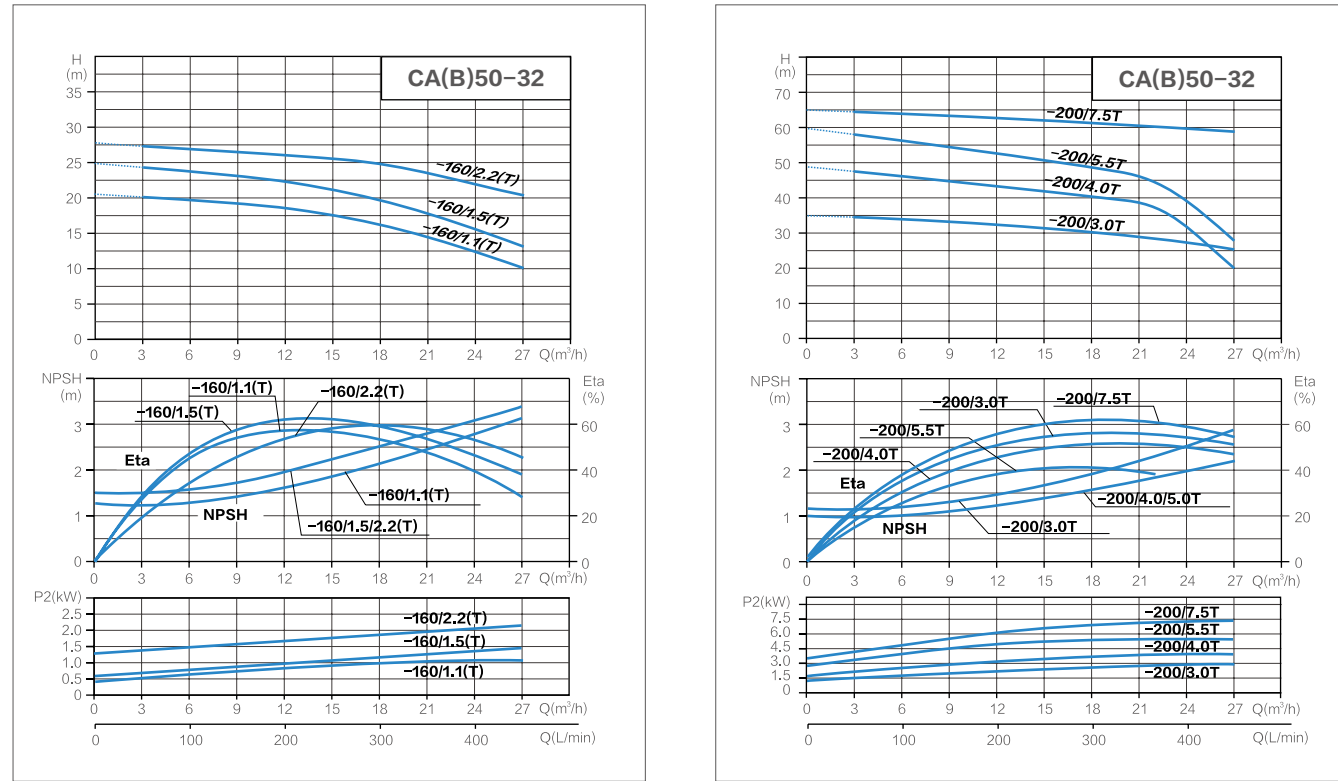

Hydraulic Performance Curves

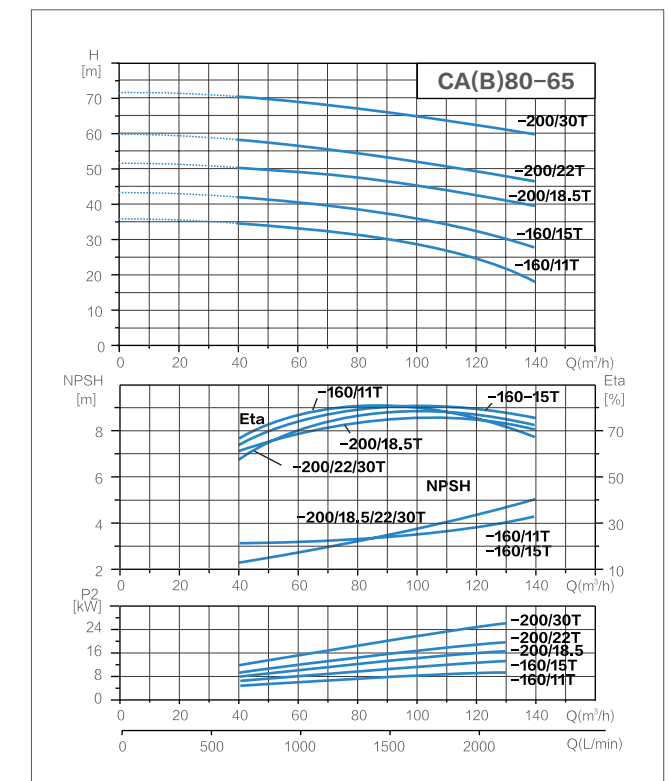
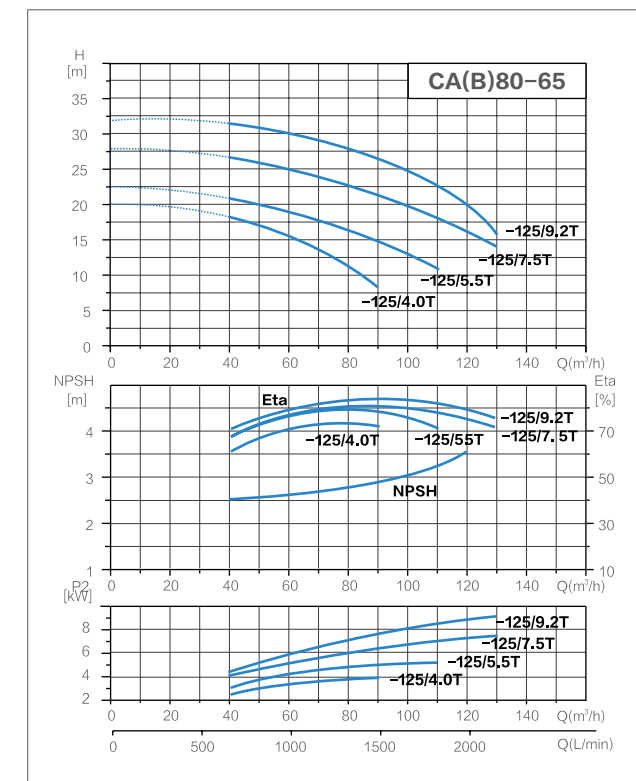
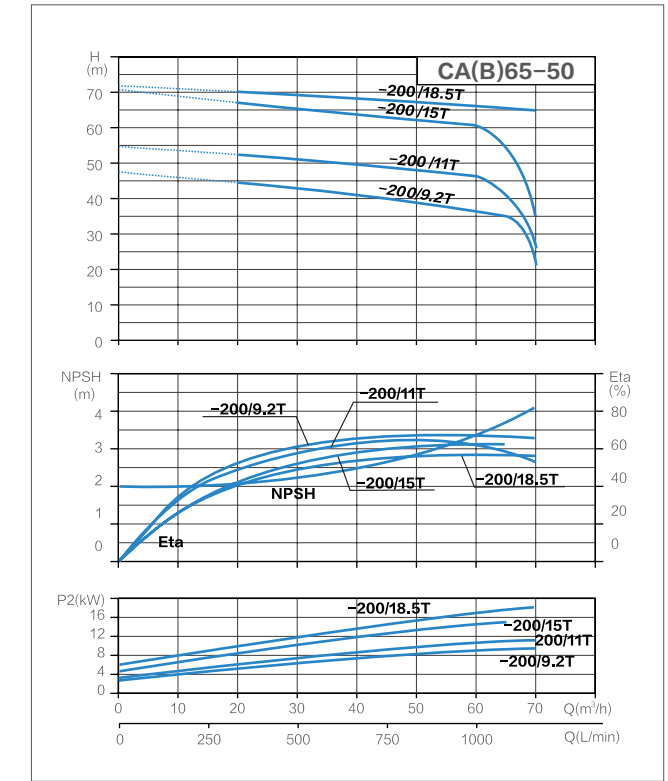
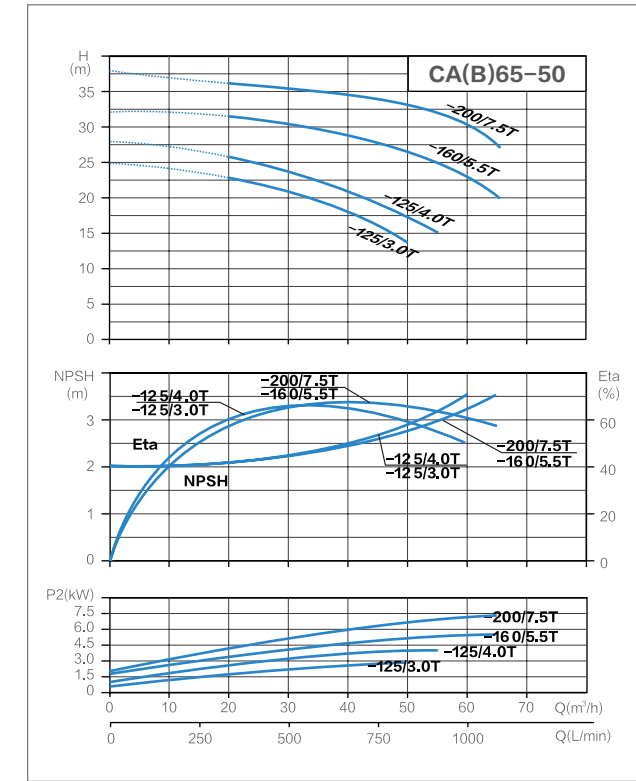

Hydraulic Performance Curves

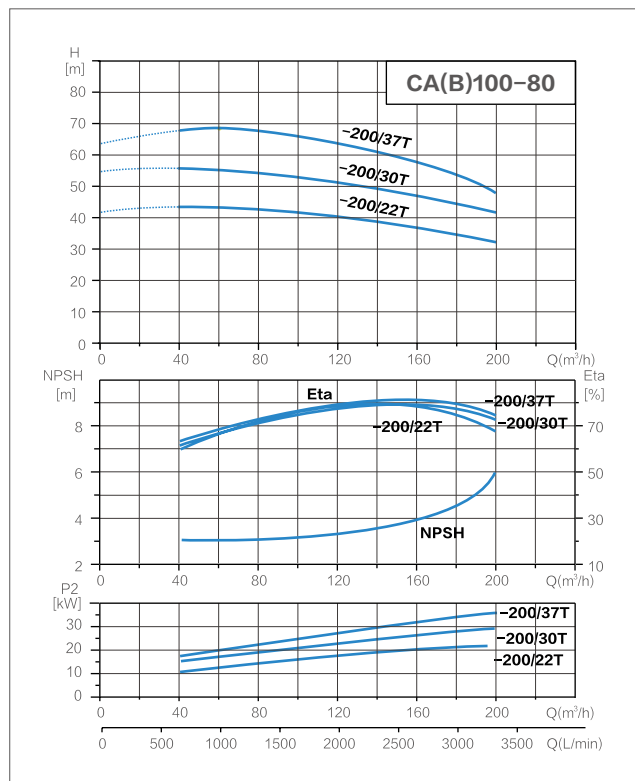
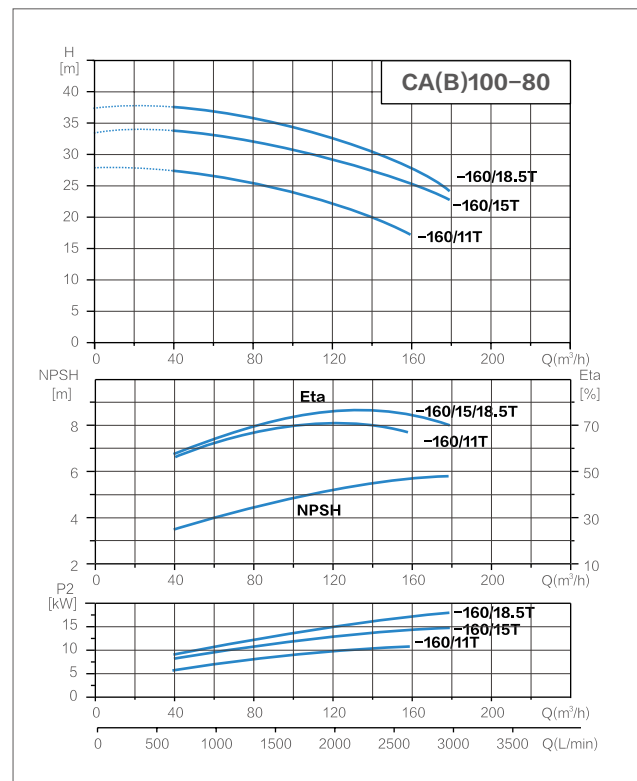

Hydraulic Performance Curves

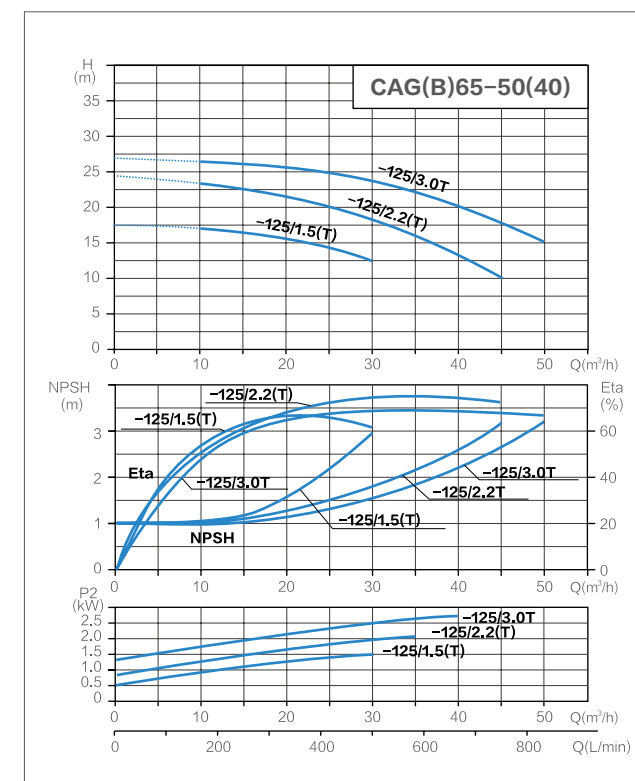
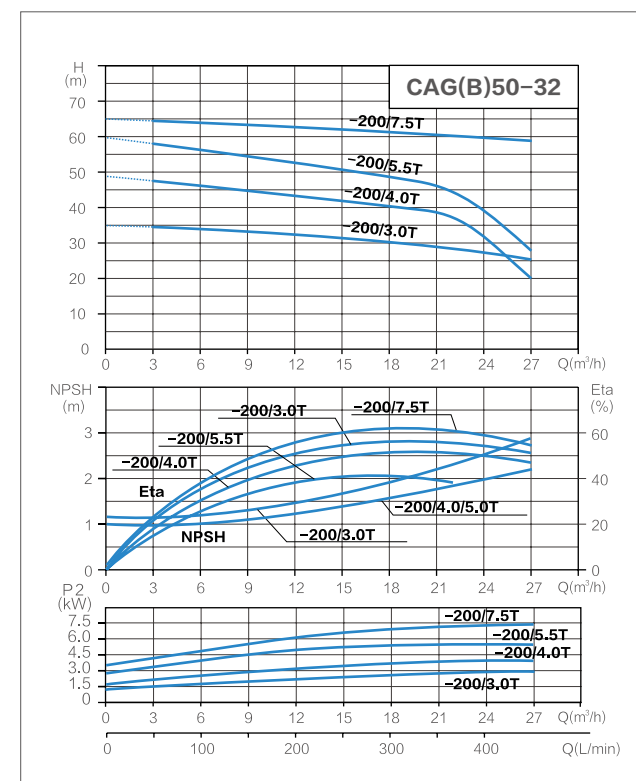
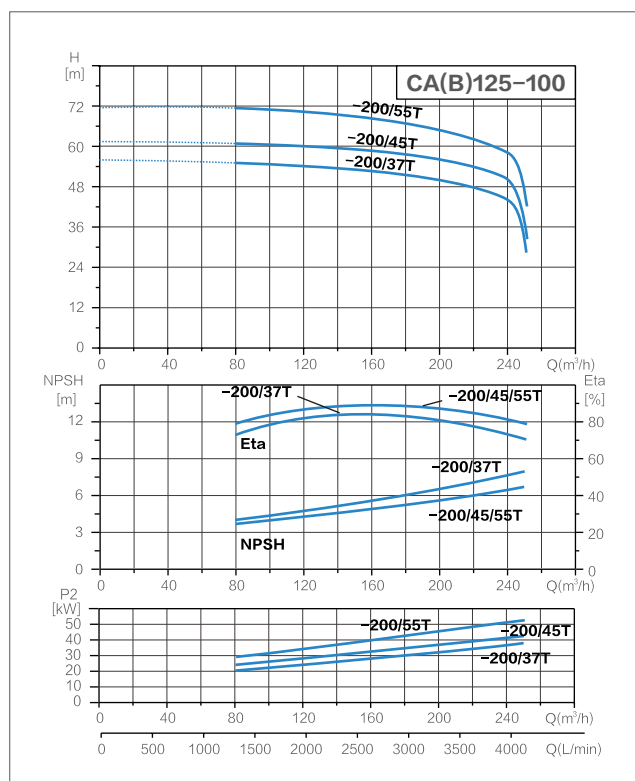
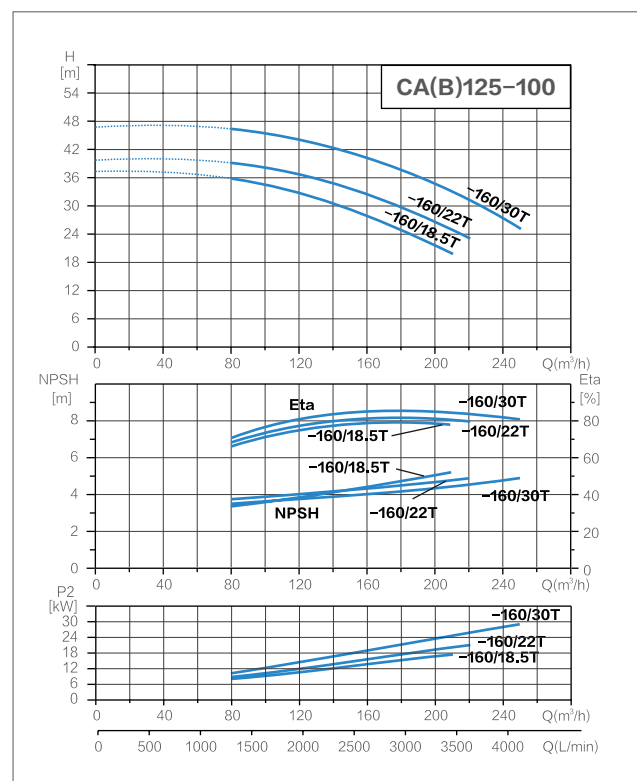
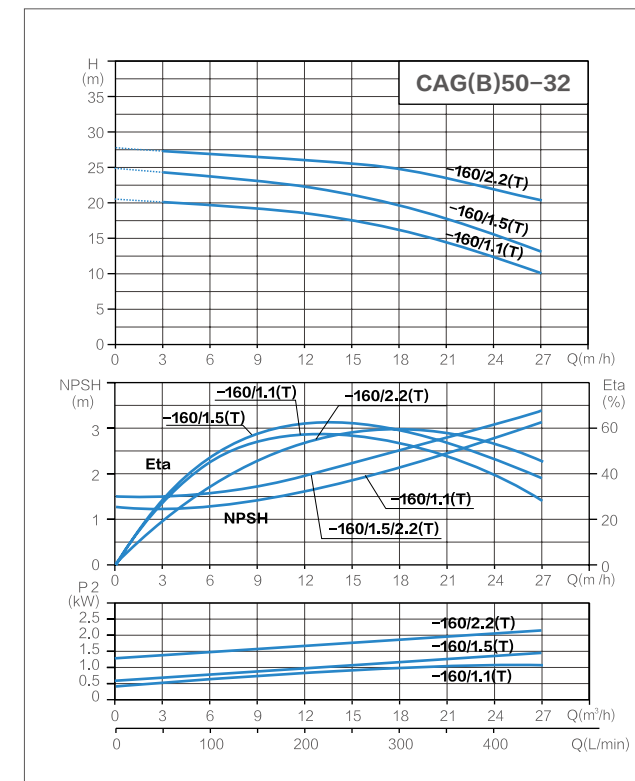
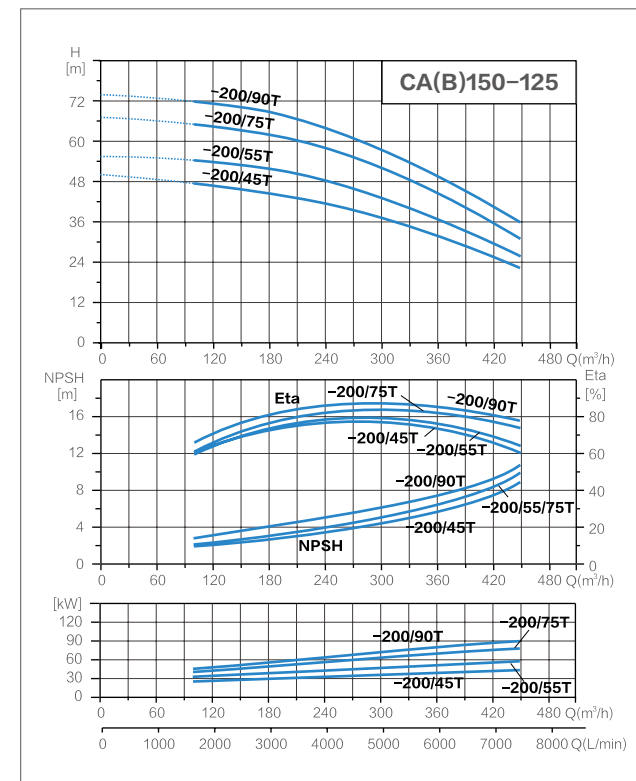

Hydraulic Performance Curves

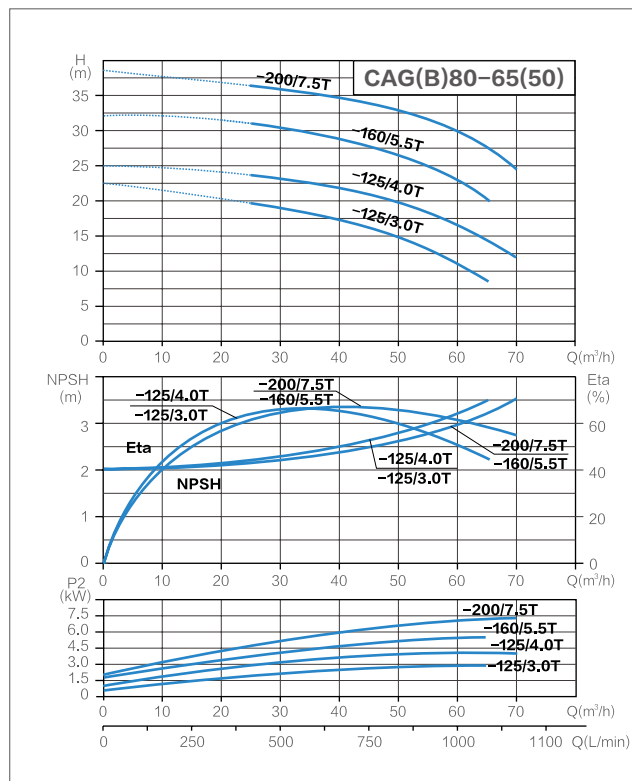
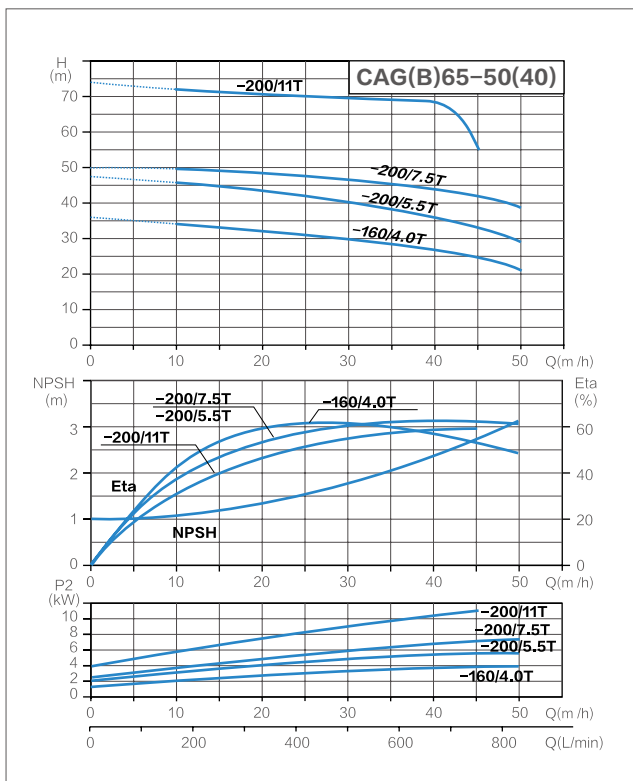

Hydraulic Performance Curves

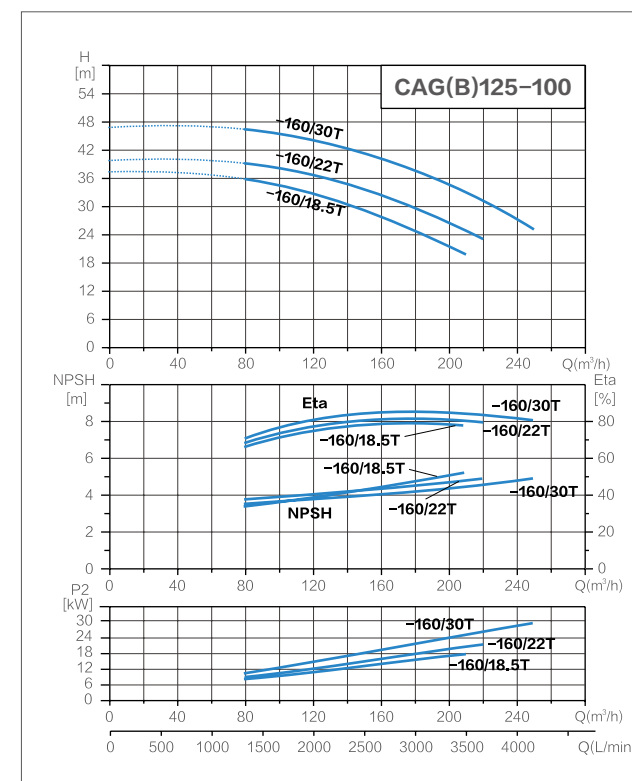
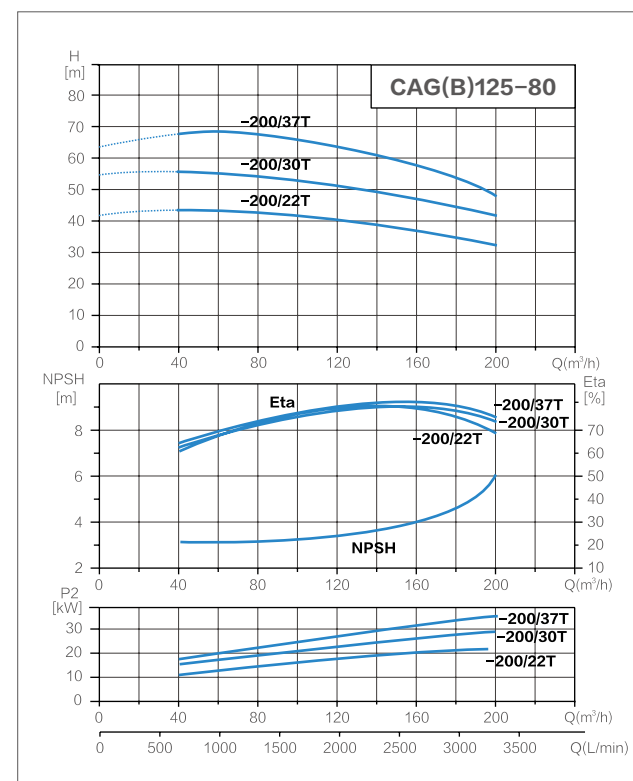
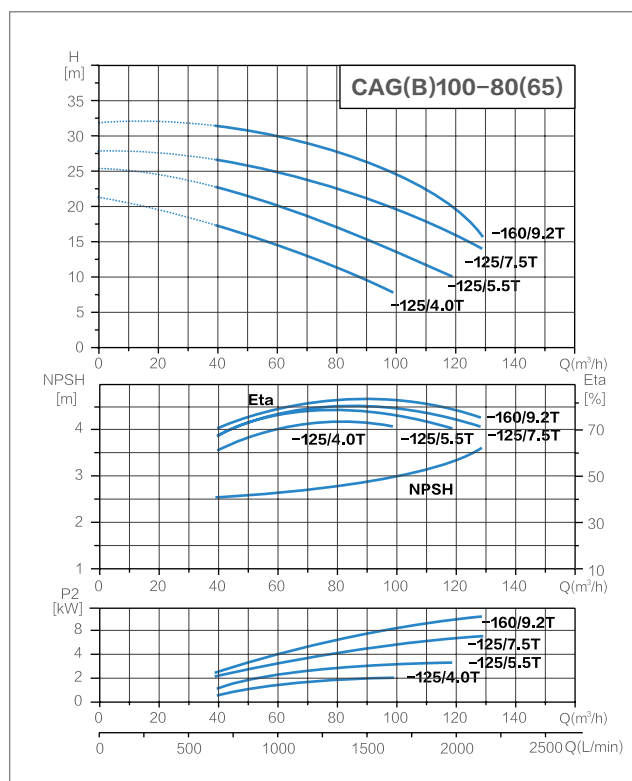
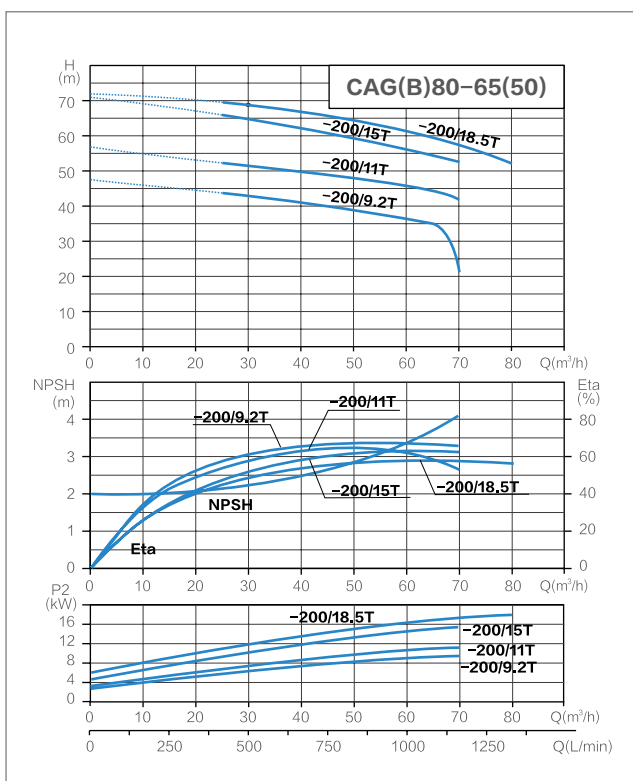
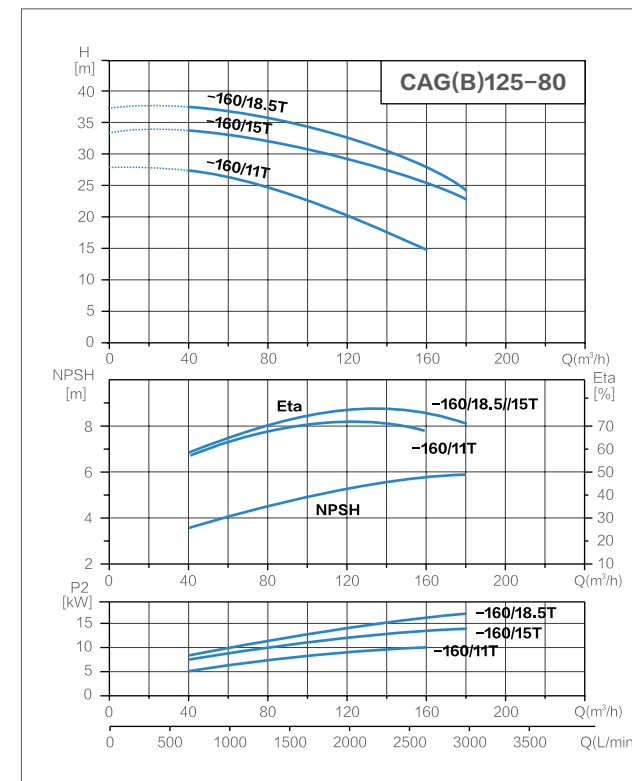
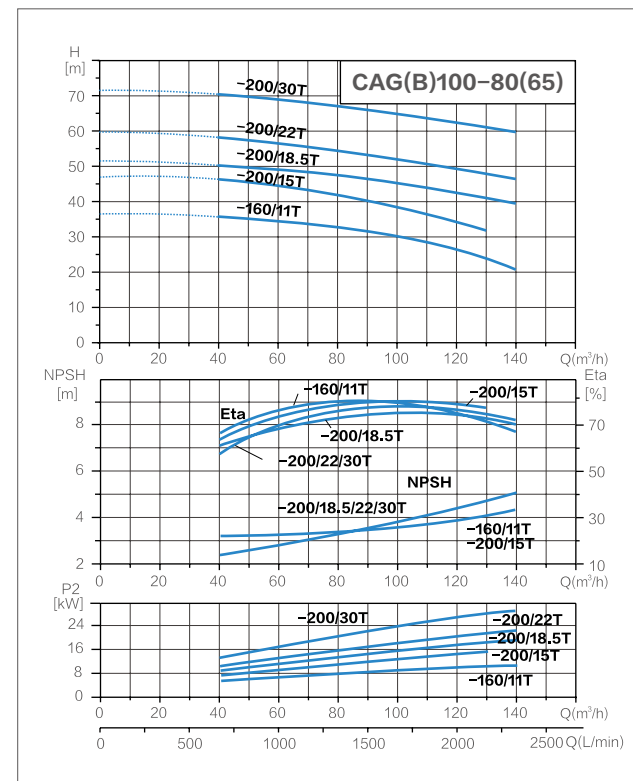

Hydraulic Performance Curves

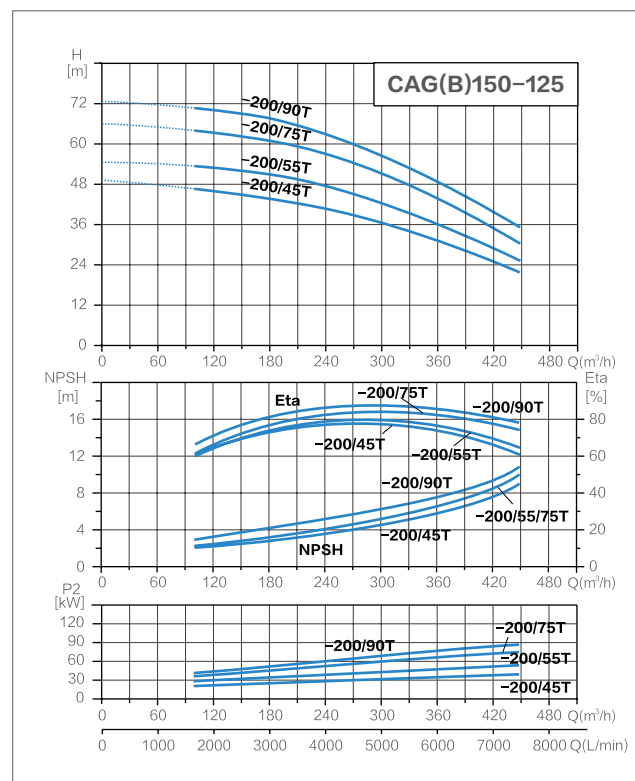
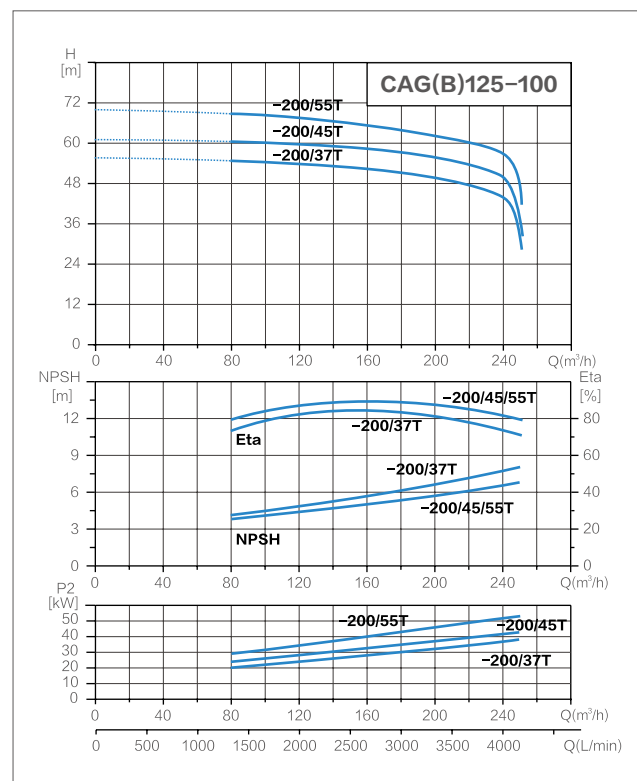

Technical Parameters

No.	Model	Power P2	Rated Flow	Rated Head	Speed	Inlet DN	Outlet DN
		KW	Qn (m³/h)	Hn (m)	r/min		
1	CA(B)50-32-160/1.1(D)	1.1	12.5	16.5	2900	50	32
2	CA(B)50-32-160/1.5(D)	1.5	12.5	20	2900	50	32
3	CA(B)50-32-160/2.2(D)	2.2	12.5	26	2900	50	32
4	CA(B)50-32-200/3.0	3	12.5	34	2900	50	32
5	CA(B)50-32-200/4.0	4	12.5	45	2900	50	32
6	CA(B)50-32-200/5.5	5.5	12.5	54	2900	50	32
7	CA(B)50-32-200/7.5	7.5	12.5	62	2900	50	32
8	CA(B)65-40-125/1.5(D)	1.5	25	13	2900	65	40
9	CA(B)65-40-125/2.2(D)	2.2	25	20	2900	65	40
10	CA(B)65-40-125/3.0	3	25	25	2900	65	40
11	CA(B)65-40-160/4.0	4	25	31	2900	65	40
12	CA(B)65-40-200/5.5	5.5	25	41	2900	65	40
13	CA(B)65-40-200/7.5	7.5	25	48	2900	65	40
14	CA(B)65-40-200/11	11	25	68	2900	65	40
15	CA(B)65-50-125/3.0	3	40	16	2900	65	50
16	CA(B)65-50-125/4.0	4	40	21	2900	65	50
17	CA(B)65-50-160/5.5	5.5	50	24	2900	65	50
18	CA(B)65-50-200/7.5	7.5	50	32	2900	65	50
19	CA(B)65-50-200/9.2	9.2	50	41	2900	65	50
20	CA(B)65-50-200/11	11	50	48	2900	65	50
21	CA(B)65-50-200/15	15	50	62	2900	65	50
22	CA(B)65-50-200/18.5	18.5	50	68	2900	65	50
23	CA(B)80-65-125/4.0	4	80	13	2900	80	65
24	CA(B)80-65-125/5.5	5.5	100	13	2900	80	65
25	CA(B)80-65-125/7.5	7.5	100	19	2900	80	65
26	CA(B)80-65-125/9.2	9.2	100	23	2900	80	65
27	CA(B)80-65-160/11	11	100	30	2900	80	65
28	CA(B)80-65-160/15	15	100	37	2900	80	65
29	CA(B)80-65-200/18.5	18.5	100	47	2900	80	65
30	CA(B)80-65-200/22	22	100	50	2900	80	65
31	CA(B)80-65-200/30	30	100	62	2900	80	65

Technical Parameters

No.	Model	Power P2	Rated Flow	Rated Head	Speed	Inlet DN	Outlet DN
		KW	Qn (m³/h)	Hn (m)	r/min		
32	CA(B)100-80-160/11	11	160	15	2900	100	80
33	CA(B)100-80-160/15	15	160	22	2900	100	80
34	CA(B)100-80-160/18.5	18.5	160	28	2900	100	80
35	CA(B)100-80-200/22	22	160	36	2900	100	80
36	CA(B)100-80-200/30	30	160	45	2900	100	80
37	CA(B)100-80-200/37	37	160	54	2900	100	80
38	CA(B)125-100-160/18.5	18.5	180	25	2900	125	100
39	CA(B)125-100-160/22	22	180	30	2900	125	100
40	CA(B)125-100-160/30	30	200	35	2900	125	100
41	CA(B)125-100-200/37	37	200	50	2900	125	100
42	CA(B)125-100-200/45	45	200	56	2900	125	100
43	CA(B)125-100-200/55	55	200	56	2900	125	100
44	CA(B)150-125-200/45	45	320	35.5	2900	150	125
45	CA(B)150-125-200/55	55	320	41	2900	150	125
46	CA(B)150-125-200/75	75	320	50	2900	150	125
47	CA(B)150-125-200/90	90	320	58	2900	150	125
48	CAG(B)50-32-160/1.1(D)	1.1	12.5	16.5	2900	50	32
49	CAG(B)50-32-160/1.5(D)	1.5	12.5	20	2900	50	32
50	CAG(B)50-32-160/2.2(D)	2.2	12.5	26	2900	50	32
51	CAG(B)50-32-200/3.0	3	12.5	34	2900	50	32
52	CAG(B)50-32-200/4.0	4	12.5	45	2900	50	32
53	CAG(B)50-32-200/5.5	5.5	12.5	54	2900	50	32
54	CAG(B)50-32-200/7.5	7.5	12.5	63	2900	50	32
55	CAG(B)65-50-125/1.5(D)	1.5	25	13	2900	65	50
56	CAG(B)65-50-125/2.2(D)	2.2	25	20	2900	65	50
57	CAG(B)65-50-125/3.0	3	25	25	2900	65	50
58	CAG(B)65-50-160/4.0	4	25	31	2900	65	50
59	CAG(B)65-40-200/5.5	5.5	25	41	2900	65	40
60	CAG(B)65-40-200/7.5	7.5	25	48	2900	65	40
61	CAG(B)65-40-200/11	11	25	68	2900	65	40
62	CAG(B)80-65-125/3.0	3	50	14.5	2900	80	65

Technical Parameters

No.	Model	Power P2	Rated Flow	Rated Head	Speed	Inlet DN	Outlet DN
		KW	Qn (m³/h)	Hn (m)	r/min		
63	CAG(B)80-65-125/4.0	4	50	20	2900	80	65
64	CAG(B)80-65-160/5.5	5.5	50	24	2900	80	65
65	CAG(B)80-65-200/7.5	7.5	50	32	2900	80	65
66	CAG(B)80-50-200/9.2	9.2	50	41	2900	80	50
67	CAG(B)80-50-200/11	11	50	48	2900	80	50
68	CAG(B)80-50-200/15	15	50	58.5	2900	80	50
69	CAG(B)80-50-200/18.5	18.5	50	64	2900	80	50
70	CAG(B)100-80-125/4.0	4	80	13	2900	100	80
71	CAG(B)100-80-125/5.5	5.5	100	13	2900	100	80
72	CAG(B)100-80-125/7.5	7.5	100	19	2900	100	80
73	CAG(B)100-80-125/9.2	9.2	100	23	2900	100	80
74	CAG(B)100-80-160/11	11	100	30	2900	100	80
75	CAG(B)100-65-200/15	15	100	38	2900	100	65
76	CAG(B)100-65-200/18.5	18.5	100	47	2900	100	65
77	CAG(B)100-65-200/22	22	100	50	2900	100	65
78	CAG(B)100-65-200/30	30	100	62	2900	100	65
79	CAG(B)125-80-160/11	11	160	15	2900	125	80
80	CAG(B)125-80-160/15	15	160	22	2900	125	80
81	CAG(B)125-80-160/18.5	18.5	160	28	2900	125	80
82	CAG(B)125-80-200/22	22	160	36	2900	125	80
83	CAG(B)125-80-200/30	30	160	45	2900	125	80
84	CAG(B)125-80-200/37	37	160	54	2900	125	80
85	CAG(B)125-100-160/18.5	18.5	180	25	2900	125	100
86	CAG(B)125-100-160/22	22	180	30	2900	125	100
87	CAG(B)125-100-160/30	30	200	35	2900	125	100
88	CAG(B)125-100-200/37	37	200	50	2900	125	100
89	CAG(B)125-100-200/45	45	200	56	2900	125	100
90	CAG(B)125-100-200/55	55	200	56	2900	125	100
91	CAG(B)150-125-200/45	45	320	35.5	2900	150	125
92	CAG(B)150-125-200/55	55	320	41	2900	150	125
93	CAG(B)150-125-200-75	75	320	50	2900	150	125
94	CAG(B)150-125-200-90	90	320	58	2900	150	125

Installation Dimension

CA, CAG Series (Without Base)

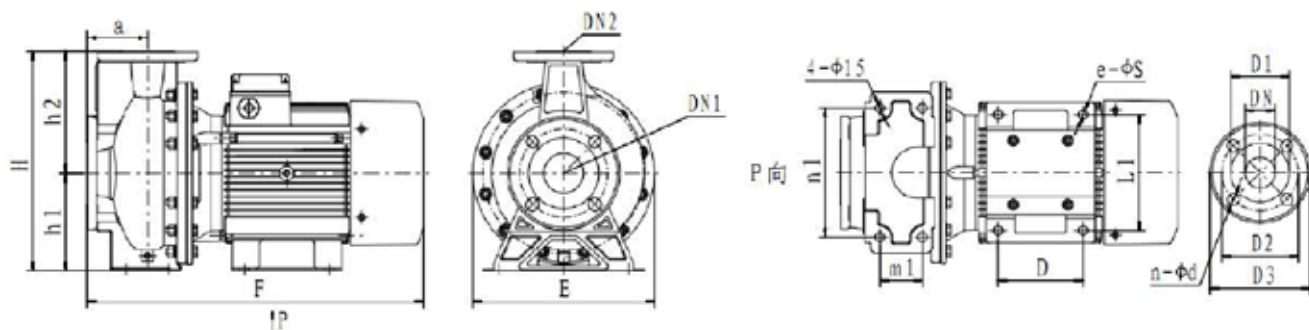

Flange Dimensions

DN	32	40	50	65	80	100	125	150
D1	76	80	96	115	132	152	180	206
D2	100	110	125	145	160	180	210	240
D3	140	150	165	185	200	220	250	285
n	4	4	4	4	8	8	8	8
d	18	18	18	18	18	18	18	22

No.	Model	Dimension (mm)												
		E	F	H	h1	h2	a	m1	n1	D	L1	e-φS	DN1	DN2
1	CA50-32-160/1.1(D)	215	390	255	112	143	80	70	160	90	125	4-φ12	50	32
2	CA50-32-160/1.5(D)	215	390	255	112	143	80	70	160	90	125	4-φ12	50	32
3	CA50-32-160/2.2(D)	215	437	255	112	143	80	70	160	100	160	4-φ12	50	32
4	CA50-32-200/3.0	298	455	340	160	180	80	70	190	100	160	4-φ12	50	32
5	CA50-32-200/4.0	298	490	340	160	180	80	70	190	140	190	4-φ15	50	32
6	CA50-32-200/5.5	298	519	340	160	180	80	70	190	140	190	4-φ15	50	32
7	CA50-32-200/7.5	298	557	340	160	180	80	70	190	140	190	4-φ15	50	32
8	CA65-40-125/1.5(D)	215	390	255	112	143	80	70	160	90	125	4-φ12	65	40
9	CA65-40-125/2.2(D)	215	437	255	112	143	80	70	160	100	160	4-φ12	65	40
10	CA65-40-125/3.0	256	456	292	132	160	80	70	190	100	160	4-φ12	65	40
11	CA65-40-160/4.0	256	491	292	132	160	80	70	190	140	190	4-φ15	65	40
12	CA65-40-200/5.5	298	541	360	160	200	100	70	212	140	190	4-φ15	65	40
13	CA65-40-200/7.5	298	579	360	160	200	100	70	212	140	190	4-φ15	65	40
14	CA65-40-200/11	298	615	360	160	200	100	70	212	140	216	4-φ15	65	40
15	CA65-50-125/3.0	256	456	292	132	160	80	70	190	100	160	4-φ12	65	50
16	CA65-50-125/4.0	256	491	292	132	160	80	70	190	140	190	4-φ15	65	50
17	CA65-50-160/5.5	298	541	360	160	200	100	70	212	140	190	4-φ15	65	50

Technical Parameters

No.	Model	Dimension (mm)												
		E	F	H	h1	h2	a	m1	n1	D	L1	e-φS	DN1	DN2
18	CA65-50-200/7.5	298	579	360	160	200	100	70	212	140	190	4-φ15	65	50
19	CA65-50-200/9.2	298	615	360	160	200	100	70	212	140	216	4-φ15	65	50
20	CA65-50-200/11	298	615	360	160	200	100	70	212	140	216	4-φ15	65	50
21	CA65-50-200/15	298	656	360	160	200	100	70	212	140	216	4-φ15	65	50
22	CA65-50-200/18.5	320	714	360	160	200	100	70	212	254	254	4-φ15	65	50
23	CA80-65-125/4.0	256	514	340	160	180	100	95	212	140	190	4-φ15	80	65
24	CA80-65-125/5.5	256	535	340	160	180	100	95	212	140	190	4-φ15	80	65
25	CA80-65-125/7.5	256	573	340	160	180	100	95	212	140	190	4-φ15	80	65
26	CA80-65-125/9.2	256	634	340	160	180	100	95	212	140	216	4-φ15	80	65
27	CA80-65-160/11	298	610	360	160	200	100	95	212	140	216	4-φ15	80	65
28	CAB80-65-160/15	298	651	360	160	200	100	95	212	140	216	4-φ15	80	65
29	CAB80-65-200/18.5	315	717	405	180	225	100	95	250	-	254	2-φ15	80	65
30	CAB80-65-200/22	356	776	405	180	225	100	95	250	241	279	4-φ15	80	65
31	CAB80-65-200/30	399	837	425	200	225	100	95	250	305	318	4-φ18.5	80	65
32	CAB100-80-160/11	290	667	405	180	225	125	95	250	140	216	4-φ15	100	80
33	CAB100-80-160/15	290	708	405	180	225	125	95	250	140	216	4-φ15	100	80
34	CAB100-80-160/18.5	354	769	405	180	225	125	95	250	-	254	2-φ15	100	80
35	CAB100-80-200/22	356	811	430	180	250	125	95	280	241	279	4-φ15	100	80
36	CAB100-80-200/30	399	872	450	200	250	125	95	280	305	318	4-φ18.5	100	80
37	CAB100-80-200/37	399	872	450	200	250	125	95	280	305	318	4-φ18.5	100	80
38	CAB125-100-160/18.5	315	780	405	180	225	125	120	280	-	254	2-φ15	125	100
39	CAB125-100-160/22	356	820	405	180	225	125	120	280	241	279	4-φ15	125	100
40	CAB125-100-160/30	400	890	425	200	225	125	120	280	305	318	4-φ18.5	125	100
41	CAB125-100-200/37	400	890	425	200	225	125	120	280	305	318	4-φ18.5	125	100
42	CAB125-100-200/45	445	910	450	225	225	125	120	280	311	356	4-φ18.5	125	100
43	CAB125-100-200/55	485	1000	475	250	225	125	120	280	349	406	4-φ18.5	125	100
44	CAB150-125-200/45	445	950	565	250	315	140	120	315	-	356	4-φ18.5	150	125
46	CAB150-125-200/75	546	1116	565	280	315	140	120	315	368	457	4-φ18.5	150	125
47	CAB150-125-200/90	546	1116	565	280	315	140	120	315	368	542	4-φ18.5	150	125
48	CAGB50-32-160/1.1(D)	215	390	255	112	143	80	70	160	90	125	4-φ12	50	32
49	CAGB50-32-160/1.5(D)	215	390	255	112	143	80	70	160	90	125	4-φ12	50	32
50	CAGB50-32-160/2.2(D)	215	437	255	112	143	80	70	160	100	160	4-φ12	50	32
51	CAGB50-32-200/3.0	298	455	340	160	180	80	70	190	100	160	4-φ12	50	32
52	CAGB50-32-200/4.0	298	490	340	160	180	80	70	190	140	190	4-φ15	50	32
53	CAGB50-32-200/5.5	298	519	340	160	180	80	70	190	140	190	4-φ15	50	32
54	CAGB50-32-200/7.5	298	557	340	160	180	80	70	190	140	190	4-φ15	50	32
55	CAGB65-50-125/1.5(D)	215	390	255	112	143	80	70	160	90	125	4-φ12	65	50
56	CAGB65-50-125/2.2(D)	215	437	255	112	143	80	70	160	100	160	4-φ12	65	50

Installation Dimension

No.	Model	Dimension (mm)												
		E	F	H	h1	h2	a	m1	n1	D	L1	e-φS	DN1	DN2
57	CAGB65-50-125/3.0	256	456	292	132	160	80	70	190	100	160	4-φ12	65	50
58	CAGB65-50-160/4.0	256	491	292	132	160	80	70	190	140	190	4-φ15	65	50
59	CAGB65-40-200/5.5	298	541	360	160	200	100	70	212	140	190	4-φ15	65	40
60	CAGB65-40-200/7.5	298	579	360	160	200	100	70	212	140	190	4-φ15	65	40
61	CAGB65-40-200/11	298	615	360	160	200	100	70	212	140	216	4-φ15	65	40
62	CAGB80-65-125/3.0	256	456	292	132	160	80	70	190	100	160	4-φ12	80	65
63	CAGB80-65-125/4.0	256	491	292	132	160	80	70	190	140	190	4-φ15	80	65
64	CAGB80-65-160/5.5	298	541	360	160	200	100	70	212	140	190	4-φ15	80	65
65	CAGB80-65-200/7.5	298	579	360	160	200	100	70	212	140	190	4-φ15	80	65
66	CAGB80-50-200/9.2	298	615	360	160	200	100	70	212	140	216	4-φ15	80	50
67	CAGB80-50-200/11	298	615	360	160	200	100	70	212	140	216	4-φ15	80	50
68	CAGB80-50-200/15	298	656	360	160	200	100	70	212	140	216	4-φ15	80	50
69	CAGB80-50-200/18.5	320	714	360	160	200	100	70	212	254	254	4-φ15	80	50
70	CAGB100-80-125/4.0	256	514	340	160	180	100	95	212	140	190	4-φ15	100	80
71	CAGB100-80-125/5.5	256	535	340	160	180	100	95	212	140	190	4-φ15	100	80
72	CAGB100-80-125/7.5	256	573	340	160	180	100	95	212	140	190	4-φ15	100	80
73	CAGB100-80-125/9.2	256	634	340	160	180	100	95	212	140	216	4-φ15	100	80
74	CAGB100-80-160/11	298	610	360	160	200	100	95	212	140	216	4-φ15	100	80
75	CAGB100-65-200/15	298	651	360	160	200	100	95	212	140	216	4-φ15	100	65
76	CAGB100-65-200/18.5	354	717	405	180	225	100	95	250	-	254	2-φ15	100	65
77	CAGB100-65-200/22	356	776	405	180	225	100	95	250	241	279	4-φ15	100	65
78	CAGB100-65-200/30	399	837	425	200	225	100	95	250	305	318	4-φ18.5	100	65
79	CAGB125-80-160/11	290	667	405	180	225	125	95	250	140	216	4-φ15	125	80
80	CAGB125-80-160/15	290	708	405	180	225	125	95	250	140	216	4-φ15	125	80
81	CAGB125-80-160/18.5	315	769	405	180	225	125	95	250	-	254	2-φ15	125	80
82	CAGB125-80-200/22	356	811	430	180	250	125	95	280	241	279	4-φ15	125	80
83	CAGB125-80-200/30	399	872	450	200	250	125	95	280	305	318	4-φ18.5	125	80
84	CAGB125-80-200/37	399	872	450	200	250	125	95	280	305	318	4-φ18.5	125	80
85	CAGB125-100-160/18.5	315	780	405	180	225	125	120	280	-	254	2-φ15	125	100
86	CAGB125-100-160/22	356	820	405	180	225	125	120	280	241	279	4-φ15	125	100
87	CAGB125-100-160/30	400	890	425	200	225	125	120	280	305	318	4-φ18.5	125	100
88	CAGB125-100-200/37	400	890	425	200	225	125	120	280	305	318	4-φ18.5	125	100
89	CAGB125-100-200/45	445	910	450	225	225	125	120	280	311	356	4-φ18.5	125	100
90	CAGB125-100-200/55	485	1000	475	250	225	125	120	280	349	406	4-φ18.5	125	100
91	CAGB150-125-200/45	445	950	565	250	315	140	120	315	-	356	4-φ18.5	150	125
92	CAGB150-125-200/55	485	1040	565	250	315	140	120	315	368	406	4-φ18.5	150	125
93	CAGB150-125-200-75	546	1116	565	280	315	140	120	315	368	457	4-φ18.5	150	125
94	CAGB150-125-200-90	546	1116	565	280	315	140	120	315	368	542	4-φ18.5	150	125

Installation Dimension

CAB, CAGB Series (With Base)

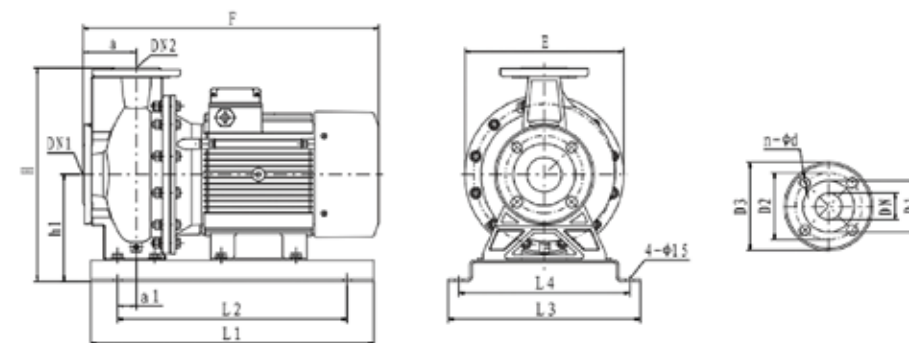

Flange Dimensions

DN	32	40	50	65	80	100	125	150
D1	76	80	96	115	132	152	180	206
D2	100	110	125	145	160	180	210	240
D3	140	150	165	185	200	220	250	285
n	4	4	4	4	8	8	8	8
d	18	18	18	18	18	18	18	22

No.	Model	Dimension (mm)												
		E	F	H	h1	h2	a	m1	n1	D	L1	e-φS	DN1	DN2
1	CAB50-32-160/1.1(D)	215	390	255	112	80	20	375	275	280	240	50	32	32
2	CAB50-32-160/1.5(D)	215	390	255	112	80	20	375	275	280	240	50	32	32
3	CAB50-32-160/2.2(D)	215	437	255	112	80	20	375	275	280	240	50	32	32
4	CAB50-32-200/3.0	298	455	340	160	80	20	425	325	340	300	50	32	32
5	CAB50-32-200/4.0	298	490	340	160	80	20	425	325	340	300	50	32	32
6	CAB50-32-200/5.5	298	519	340	160	80	20	425	325	340	300	50	32	32
7	CAB50-32-200/7.5	298	557	340	160	80	20	425	325	340	300	50	32	32
8	CAB65-40-125/1.5(D)	215	390	255	112	80	20	375	275	280	240	65	40	40
9	CAB65-40-125/2.2(D)	215	437	255	112	80	20	375	275	280	240	65	40	40
10	CAB65-40-125/3.0	256	456	292	132	80	20	425	325	340	300	65	40	40
11	CAB65-40-160/4.0	256	491	292	132	80	20	425	325	340	300	65	40	40
12	CAB65-40-200/5.5	298	541	360	160	100	35	480	380	350	310	65	40	40
13	CAB65-40-200/7.5	298	579	360	160	100	35	480	380	350	310	65	40	40
14	CAB65-40-200/11	298	615	360	160	100	30	600	400	390	350	65	40	40
15	CAB65-50-125/3.0	256	456	292	132	80	20	425	325	340	300	65	50	50
16	CAB65-50-125/4.0	256	491	292	132	80	20	425	325	340	300	65	50	50
17	CAB65-50-160/5.5	298	541	360	160	100	35	480	380	350	310	65	50	50

Technical Parameters

No.	Model	Dimension (mm)												
		E	F	H	h1	h2	a	m1	n1	D	L1	e-φS	DN1	DN2
18	CAB65-50-200/7.5	298	579	360	160	100	35	480	380	350	310	65	50	50
19	CAB65-50-200/9.2	298	615	360	160	100	30	600	400	390	350	65	50	50
20	CAB65-50-200/11	298	615	360	160	100	30	600	400	390	350	65	50	50
21	CAB65-50-200/15	298	656	360	160	100	30	600	400	390	350	65	50	50
22	CAB65-50-200/18.5	315	714	360	160	100	35	650	450	326	290	65	50	50
23	CAB80-65-125/4.0	256	514	340	160	100	32	480	380	350	310	80	65	65
24	CAB80-65-125/5.5	256	535	340	160	100	32	480	380	350	310	80	65	65
25	CAB80-65-125/7.5	256	573	340	160	100	32	480	380	350	310	80	65	65
26	CAB80-65-125/9.2	256	634	340	160	100	18	600	400	390	350	80	65	65
27	CAB80-65-160/11	298	610	360	160	100	18	600	400	390	350	80	65	65
28	CAB80-65-160/15	298	651	360	160	100	18	600	400	390	350	80	65	65
29	CAB80-65-200/18.5	315	717	405	180	100	23	650	450	326	290	80	65	65
30	CAB80-65-200/22	356	776	405	180	100	18	750	550	416	370	80	65	65
31	CAB80-65-200/30	400	837	425	200	100	18	800	600	396	350	80	65	65
32	CAB100-80-160/11	256	667	405	180	125	13	650	450	390	350	100	80	80
33	CAB100-80-160/15	256	708	405	180	125	13	650	450	390	350	100	80	80
34	CAB100-80-160/18.5	315	769	405	180	125	8	750	550	326	290	100	80	80
35	CAB100-80-200/22	356	811	430	180	125	8	750	550	356	310	100	80	80
36	CAB100-80-200/30	400	872	450	200	125	8	800	600	396	350	100	80	80
37	CAB100-80-200/37	400	872	450	200	125	8	800	600	396	350	100	80	80
38	CAB125-100-160/18.5	315	780	405	180	125	5	750	550	326	290	125	100	100
39	CAB125-100-160/22	356	820	405	180	125	6	800	600	356	310	125	100	100
40	CAB125-100-160/30	400	890	425	200	125	6	850	650	396	350	125	100	100
41	CAB125-100-200/37	400	890	425	200	125	6	850	650	466	420	125	100	100
42	CAB125-100-200/45	445	910	450	225	125	6	850	650	436	390	125	100	100
43	CAB125-100-200/55	485	100	475	250	125	6	950	750	486	440	125	100	100
44	CAB150-125-200/45	445	950	565	250	140	8	850	650	650	410	150	125	125
46	CAB150-125-200/55	485	1040	565	250	140	8	950	750	486	440	150	125	125
47	CAB150-125-200/75	546	1116	565	280	140	8	1050	850	541	495	150	125	125
48	CAB150-125-200/90	546	1116	565	280	140	8	1050	850	541	495	150	125	32
49	CAGB50-32-160/1.5(D)	215	390	255	112	80	20	375	275	280	240	50	32	32
50	CAGB50-32-160/2.2(D)	215	437	255	112	80	20	375	275	280	240	50	32	32
51	CAGB50-32-200/3.0	298	455	340	160	80	20	425	325	340	300	50	32	32
52	CAGB50-32-200/4.0	298	490	340	160	80	20	425	325	340	300	50	32	32
53	CAGB50-32-200/5.5	298	519	340	160	80	20	425	325	340	300	50	32	32
54	CAGB50-32-200/7.5	298	557	340	160	80	20	425	325	340	300	50	32	32
55	CAGB65-50-125/1.5(D)	215	390	255	112	80	20	375	275	280	240	65	50	50
56	CAGB65-50-125/2.2(D)	215	437	255	112	80	20	375	275	280	240	65	50	50

Installation Dimension

No.	Model	Dimension (mm)												
		E	F	H	h1	h2	a	m1	n1	D	L1	e-φS	DN1	DN2
57	CAGB65-50-125/3.0	256	456	292	132	80	20	425	325	340	300	65	50	50
58	CAGB65-50-160/4.0	256	491	292	132	80	20	425	325	340	300	65	50	50
59	CAGB65-40-200/5.5	298	541	360	160	100	35	480	380	350	310	65	40	40
60	CAGB65-40-200/7.5	298	579	360	160	100	35	480	380	350	310	65	40	40
61	CAGB65-40-200/11	298	615	360	160	100	30	600	400	390	350	65	40	40
62	CAGB80-65-125/3.0	256	456	292	132	80	20	425	325	340	300	80	65	65
63	CAGB80-65-125/4.0	256	491	292	132	80	20	425	325	340	300	80	65	65
64	CAGB80-65-160/5.5	298	541	360	160	100	35	480	380	350	310	80	65	65
65	CAGB80-65-200/7.5	298	579	360	160	100	35	480	380	350	310	80	65	65
66	CAGB80-50-200/9.2	298	615	360	160	100	30	600	400	390	350	80	50	50
67	CAGB80-50-200/11	298	615	360	160	100	30	600	400	390	350	80	50	50
68	CAGB80-50-200/15	298	656	360	160	100	30	600	400	390	350	80	50	50
69	CAGB80-50-200/18.5	315	714	360	160	100	35	650	450	326	290	80	50	50
70	CAGB100-80-125/4.0	256	514	340	160	100	32	480	380	350	310	100	80	80
71	CAGB100-80-125/5.5	256	535	340	160	100	32	480	380	350	310	100	80	80
72	CAGB100-80-125/7.5	256	573	340	160	100	32	480	380	350	310	100	80	80
73	CAGB100-80-125/9.2	256	634	340	160	100	18	600	400	390	350	100	80	80
74	CAGB100-80-160/11	298	610	360	160	100	18	600	400	390	350	100	80	80
75	CAGB100-65-200/15	298	651	360	160	100	18	600	400	390	350	100	65	65
76	CAGB100-65-200/18.5	315	717	405	180	100	23	650	450	326	290	100	65	65
77	CAGB100-65-200/22	356	776	405	180	100	18	750	550	416	370	100	65	65
78	CAGB100-65-200/30	400	837	425	200	100	18	800	600	396	350	100	65	65
79	CAGB125-80-160/11	256	667	405	180	125	13	650	450	390	350	125	80	80
80	CAGB125-80-160/15	256	708	405	180	125	13	650	450	390	350	125	80	80
81	CAGB125-80-160/18.5	315	769	405	180	125	8	750	550	326	290	125	80	80
82	CAGB125-80-200/22	356	811	430	180	125	8	750	550	356	310	125	80	80
83	CAGB125-80-200/30	400	872	450	200	125	8	800	600	396	350	125	80	80
84	CAGB125-80-200/37	400	872	450	200	125	8	800	600	396	350	125	80	80
85	CAGB125-100-160/18.5	315	780	405	180	125	5	750	550	326	290	125	100	100
86	CAGB125-100-160/22	356	820	405	180	125	6	800	600	356	310	125	100	100
87	CAGB125-100-160/30	400	890	425	200	125	6	850	650	396	350	125	100	100
88	CAGB125-100-200/37	400	890	425	200	125	6	850	650	466	420	125	100	100
89	CAGB125-100-200/45	445	910	450	225	125	6	850	650	436	390	125	100	100
90	CAGB125-100-200/55	485	100	475	250	125	6	950	750	486	440	125	100	100
91	CAGB150-125-200/45	445	950	565	250	140	8	850	650	650	410	150	125	125
92	CAGB150-125-200/55	485	1040	565	250	140	8	950	750	486	440	150	125	125
93	CAGB150-125-200-75	546	1116	565	280	140	8	1050	850	541	495	150	125	125
94	CAGB150-125-200-90	546	1116	565	280	140	8	1050	850	541	495	150	125	125

MS

Horizontal Single-Stage Centrifugal Pump



Private House



Agricultural



Civil use



Industrial use



Product Overview

MS series of pump is single-stage centrifugal pump and features axial suction and radial discharge; Compact structure, The pump is directly connected with the motor, coaxial installation; Convenient installation, screw thread water inlet and outlet; Light weight, thin plate pressing structure for main parts and components; Corrosion resistance, components passing the flow use AISI 304 stainless steel.

All the parts contact with liquid made of 304 stainless steel. Mechanical seal are standard supply.

All stainless steel horizontal single stage not self-priming pump with axial suction, vertical discharge threaded connections.

Applications

- For Domestic Water Supply
- In Water treatment
- In Water Circulation System
- In Gardens for Drip Irrigation, Water Sprinklers, Water Fountains, etc.
- Pressurisation and Pumping of Clean Water
- In Food & Beverages Industry
- In Pharmaceutical & Biotech Industry

Features

- Hydraulic parts
- Light Weight
- Compact Structure
- All stainless steel horizontal single stage not self-priming pump with axial suction, vertical discharge threaded connections.

Model Implication

MS m 210 / 1.5

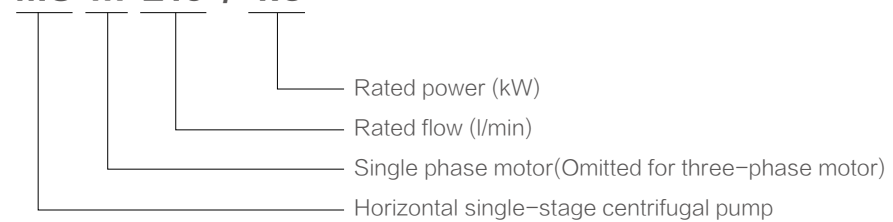

Hydraulic Performance Curves

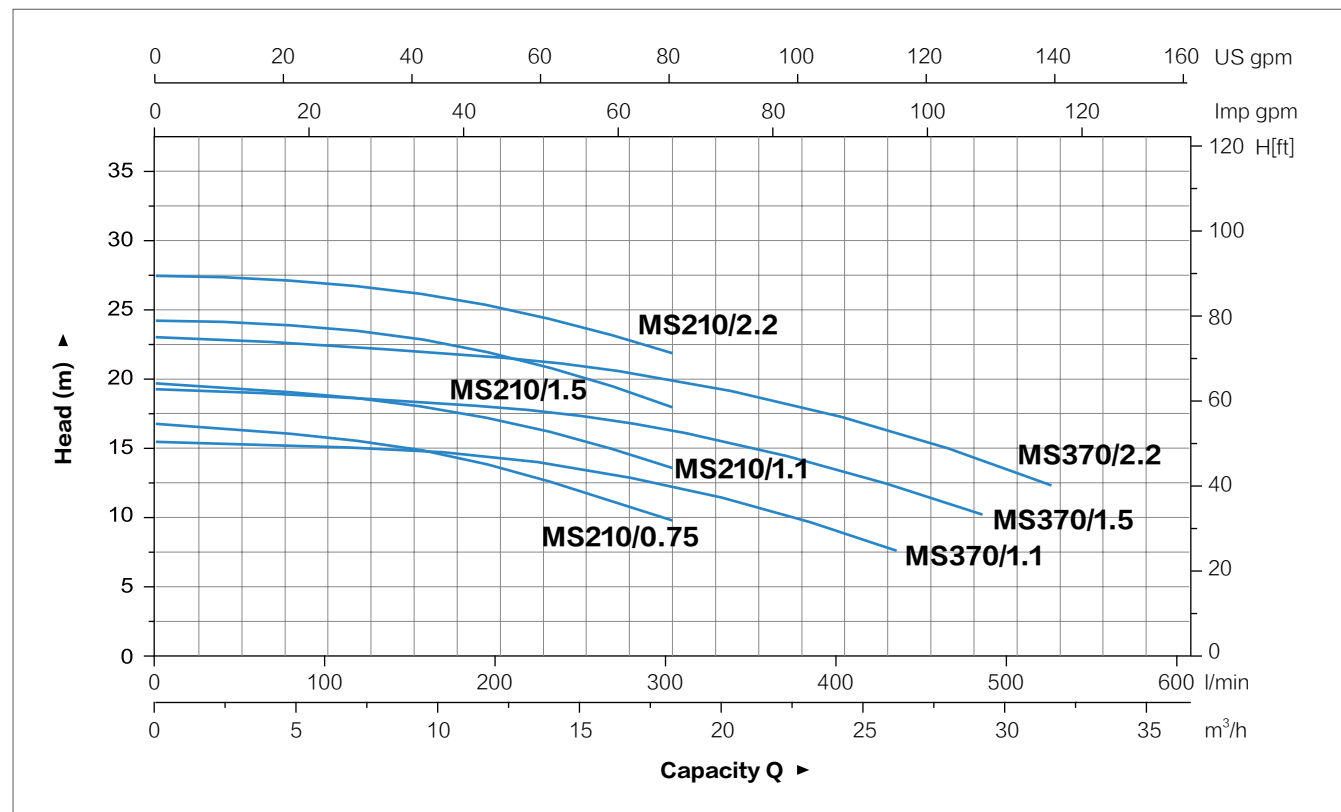
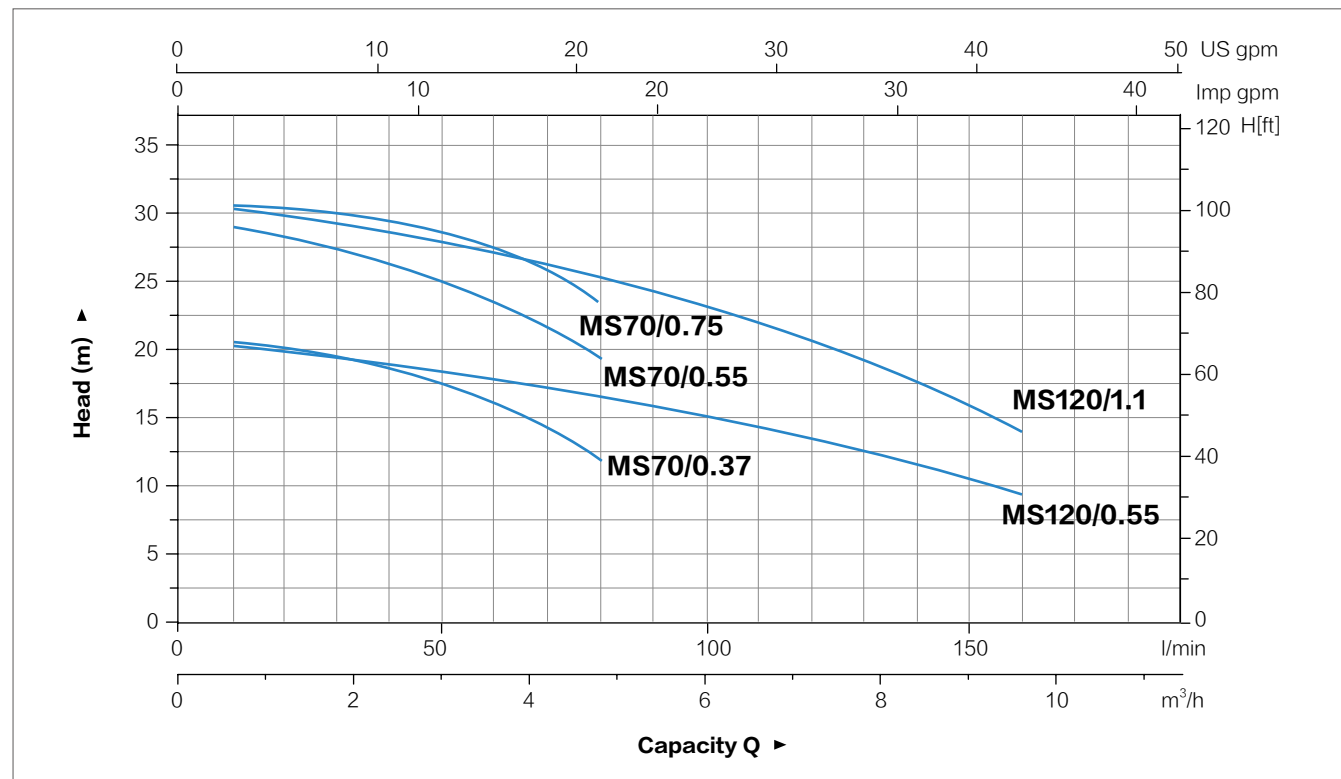

Technical Parameters

No.	Model		Power		0	1.8	2.4	3.6	4.8	6	7.2	8.4	9.6	10.8
	Single Phase	Three Phase	KW	HP	0	30	40	60	80	100	120	140	160	180
1	MSm70/0.37	MS70/0.37	0.37	0.5	20.9	19	18.1	15.7	12.1	-	-	-	-	-
2	MSm70/0.55	MS70/0.55	0.55	0.75	29.5	27.3	26.3	23.4	19.1	-	-	-	-	-
3	MSm70/0.75	MS70/0.75	0.75	1	30.4	28.5	27.8	26	23	-	-	-	-	-
4	MSm120/0.55	MS120/0.55	0.55	0.75	20.2	-	-	17.9	16.6	15.1	13.3	11.2	8.7	-
5	MSm120/1.1	MS120/1.1	1.1	1.5	30.2	-	-	26.7	25.1	23.3	21.2	19	16.4	-

No.	Model		Power		0	7.2	8.4	9.6	10.8	12	15	18	21	24	26	29	31
	Single Phase	Three Phase	KW	HP	0	120	140	160	180	200	250	300	350	400	430	480	520
6	MSm210/0.75	MS210/0.75	0.75	1	16.8	15.6	15.2	14.8	14.2	13.6	11.9	9.8	-	-	-	-	-
7	MSm210/1.1	MS210/1.1	1.1	1.5	19.7	18.7	18.3	18	17.5	17.1	15.6	13.6	-	-	-	-	-
8	MSm210/1.5	MS210/1.5	1.5	2	24.2	23.5	23.2	22.8	22.4	21.8	20.2	18	-	-	-	-	-
9	MSm210/2.2	MS210/2.2	2.2	3	27.5	26.7	26.5	26.1	25.7	25.2	23.8	21.9	-	-	-	-	-
10	MSm370/1.1	MS370/1.1	1.1	1.5	15.4	-	-	-	14.7	14.4	13.5	12.3	10.8	8.9	7.6	-	-
11	MSm370/1.5	MS370/1.5	1.5	2	19.3	-	-	-	18.1	17.3	16.3	15	13.3	12.3	10.2	-	-
12	MSm370/2.2	MS370/2.2	2.2	3	23.1	-	-	-	21.7	20.9	20	18.8	17.2	16.2	14.2	12.3	-

Dimension

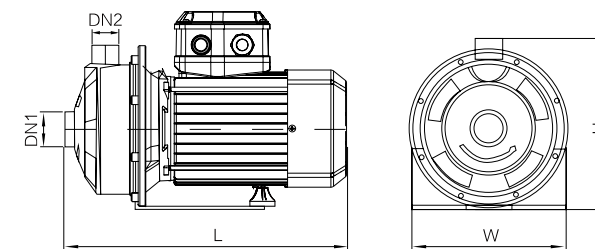

No.	Model	DN1	DN2	L (mm)	W (mm)	H (mm)	L1 (mm)	L2 (mm)	W1 (mm)	H1 (mm)
1	MS(m)70/0.37	1 1/4"	1"	332	210	224	119	55	149	110
2	MS(m)70/0.55			332	210	224	119	55	149	110
3	MS(m)70/0.75			381	210	224	119	55	149	110
4	MS(m)120/0.55			332	210	224	119	55	149	110
5	MS(m)120/1.1			381	210	234	119	55	149	110
6	MS(m)210/0.75	1 1/2"	1 1/4"	392	210	234	129	55	149	110
7	MS(m)210/1.1			392	210	234	129	55	149	110
8	MS(m)210/1.5			440	210	250	129	55	149	110
9	MS(m)210/2.2			440	210	250	129	55	149	110
10	MS(m)370/1.1	2"	1 1/4"	392	210	234	129	55	149	110
11	MS(m)370/1.5			440	210	250	129	55	149	110
12	MS(m)370/2.2			440	210	250	129	55	149	110

CMI

Stainless Steel Horizontal Multistage Centrifugal Pump



Private House



Agricultural



Civil use



Industrial use



Application

- Air conditioning system
- Water treatment
- Water pressurization on the processing line
- Heating and cooling water for industrial production lines
- Conveying liquid that is thin, clean, non-flammable, non-explosive, free of solid particles and fibers
- Air freshening, humidification equipment (soft water)
- Water supply pressurization (drinking water)
- Fertilization/metering system
- Aquaculture

Operation Conditions

- Liquid: thin, clean, non-flammable and explosive liquid without solid particles or fibers.
- Liquid temperature: Low temperature: -20°C to $+70^{\circ}\text{C}$
Normal temperature: $+15^{\circ}\text{C}$ to $+70^{\circ}\text{C}$
High temperature: $+70^{\circ}\text{C}$ to 104°C
- PH value: between 6.5-8.5
- Ambient temperature: $\leq 40^{\circ}\text{C}$
- Altitude: $\leq 1000\text{m}$
- Max. working pressure: 1.0Mpa
- Voltage fluctuation range: $\pm 10\%$
- Before use, it must be filled with water to drain the air in the pump, otherwise the water cannot be pumped normally.

Motor

- Voltage & Frequency: Single-phase 220-240V/50Hz, three-phase 380-415V/50Hz (60Hz and different voltages can be customized).
- Motor poles: 2 poles
- Insulation class: F
- Protection class: IP55
- Working system: S1
- Built-in thermal protector for single-phase motor
- Bearing: C&U high temperature bearing
- Max. times of motor starts per hour: 20 times; motor starts times(lifetime): $\geq 100,000$ times.

Model Implication

CMI 3 - 2 (D) - A - W - G BABE

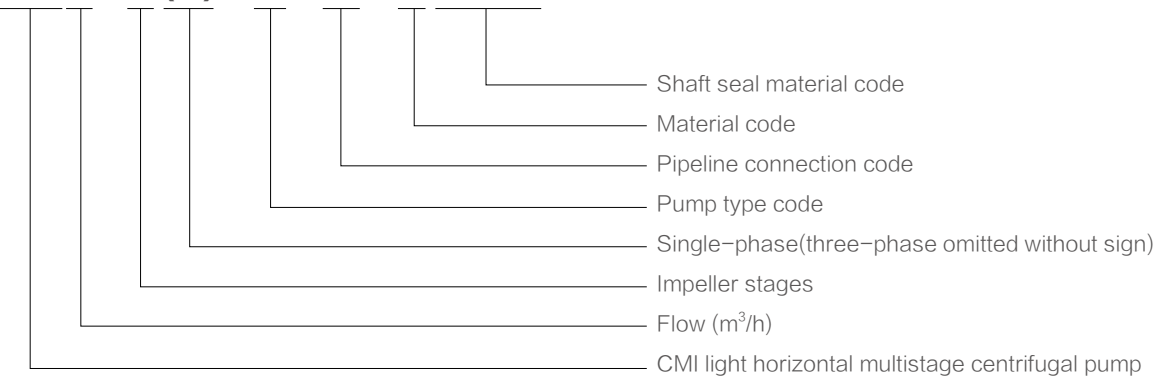

Model Implication

A - W - G - B AB E

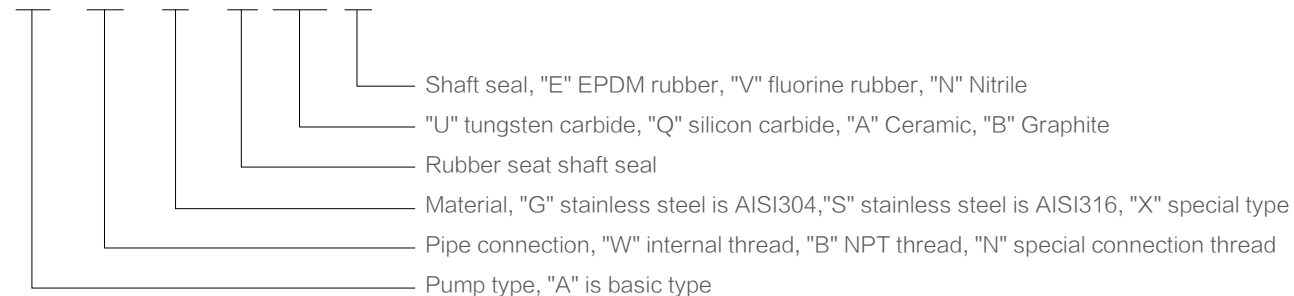

Structure

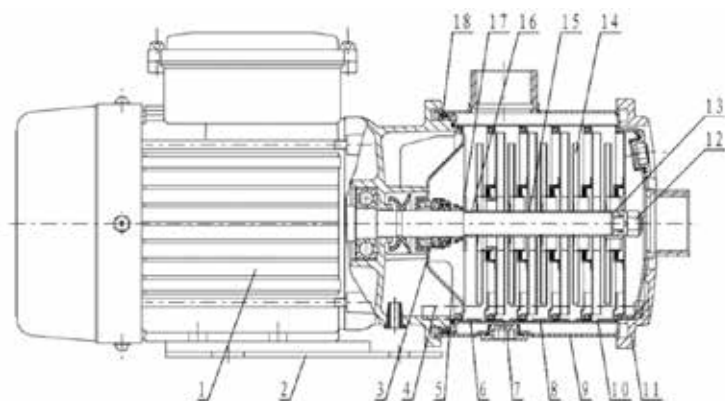

No.	Part	Material	No.	Part	Material
1	Motor		10	Inlet Section	SUS304
2	Bottom Plate	A3	11	Clamp	ADC12
3	Mechanical Seal	Graphite/Ceramic/EPDM	12	Nut	SUS304
4	Hexagon Socket Screw	A3	13	Impeller Press Tube	SUS304
5	Pump Cover	SUS304	14	Impeller	SUS304
6	Outlet Section	SUS304	15	Long Sleeve	SUS304
7	Plug	SUS304	16	Short Sleeve	SUS304
8	Middle Section	SUS304	17	Flat Washer	SUS304
9	Pump Casing	SUS304	18	O-Ring	NBR

Hydraulic Performance Curves

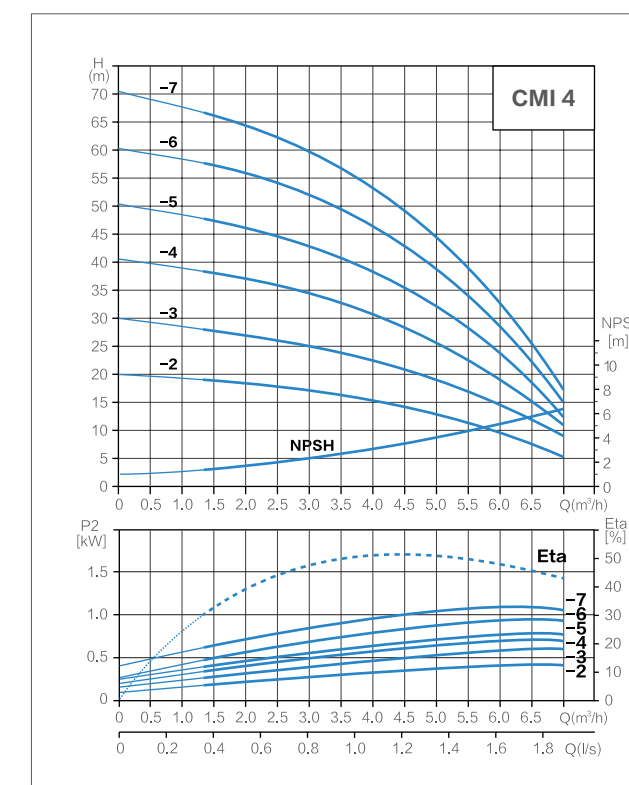
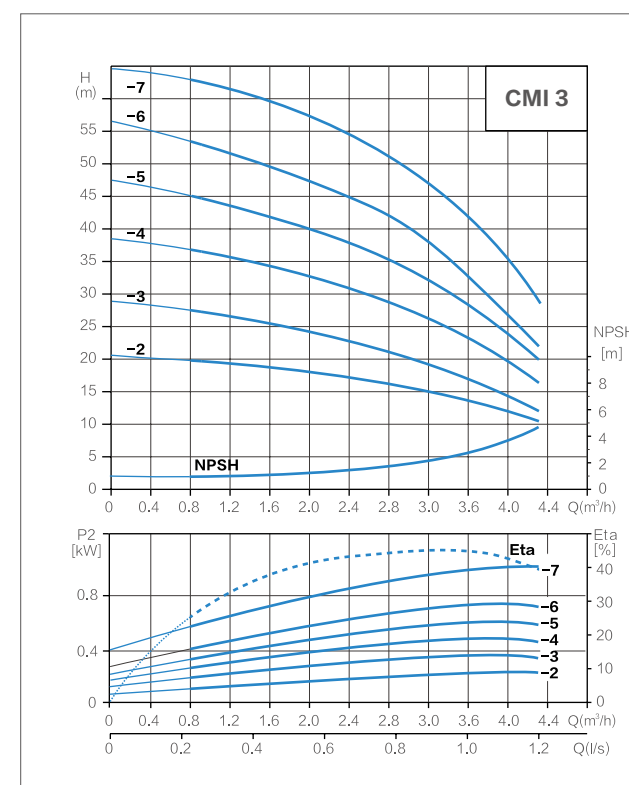
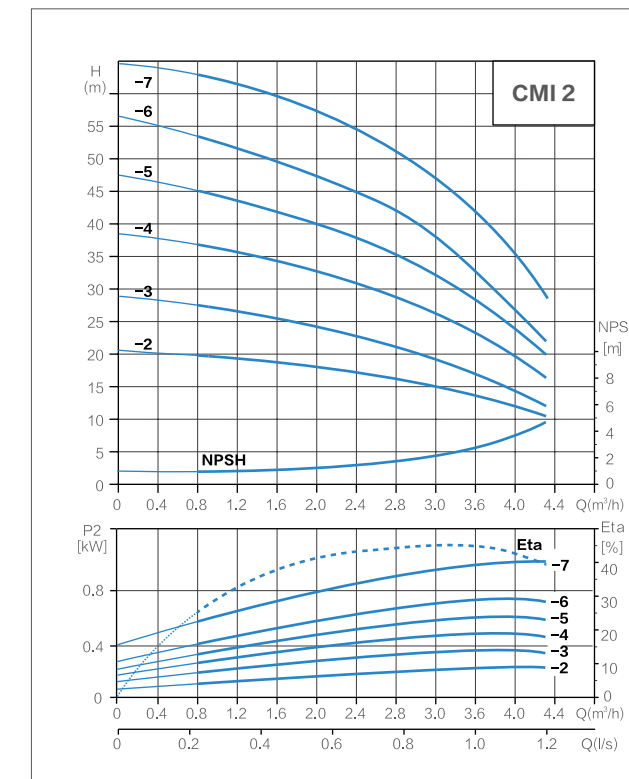
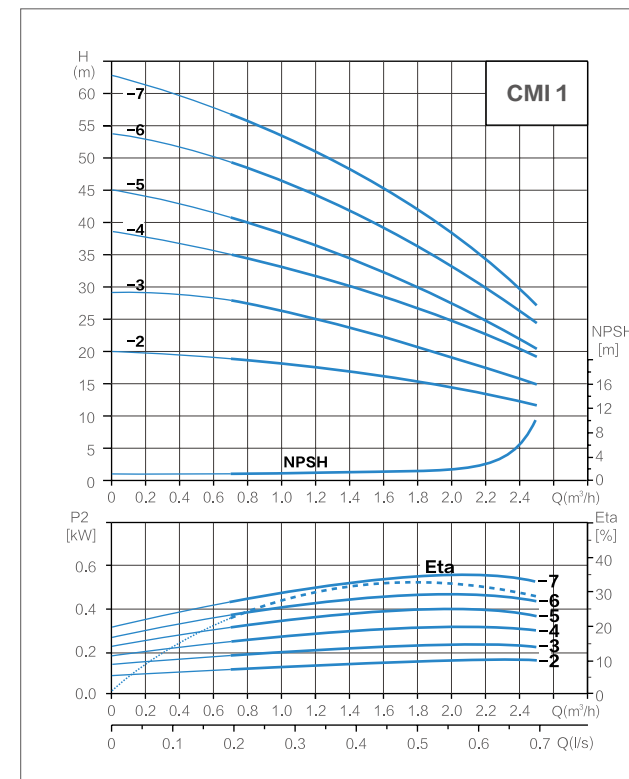

Hydraulic Performance Curves

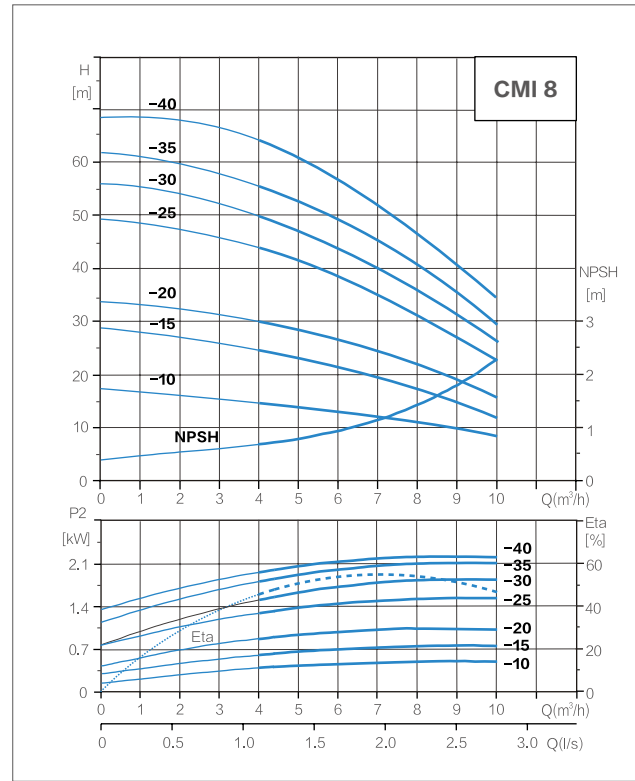
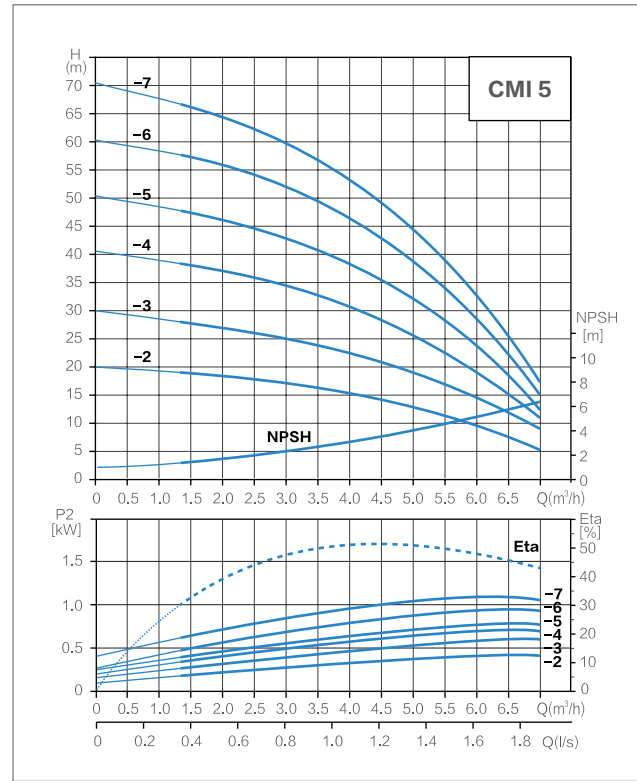

Hydraulic Performance Curves

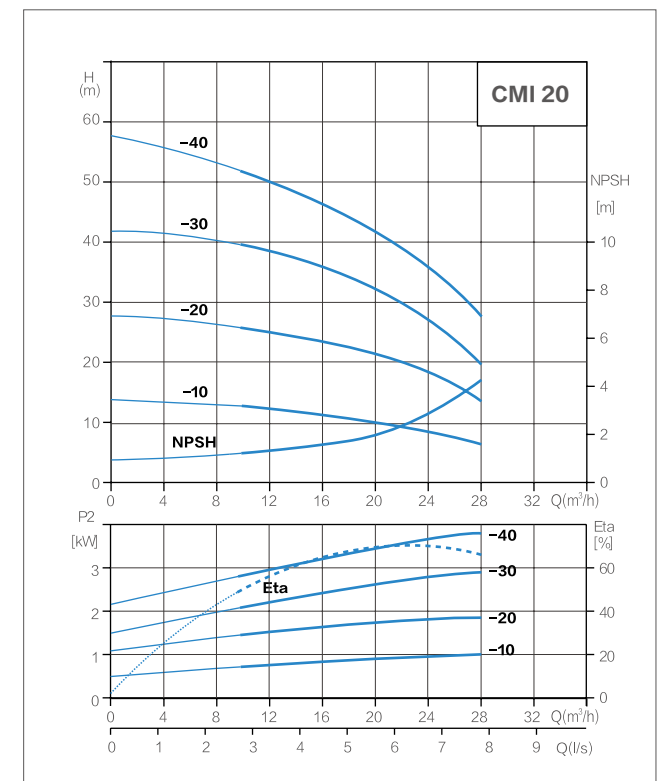
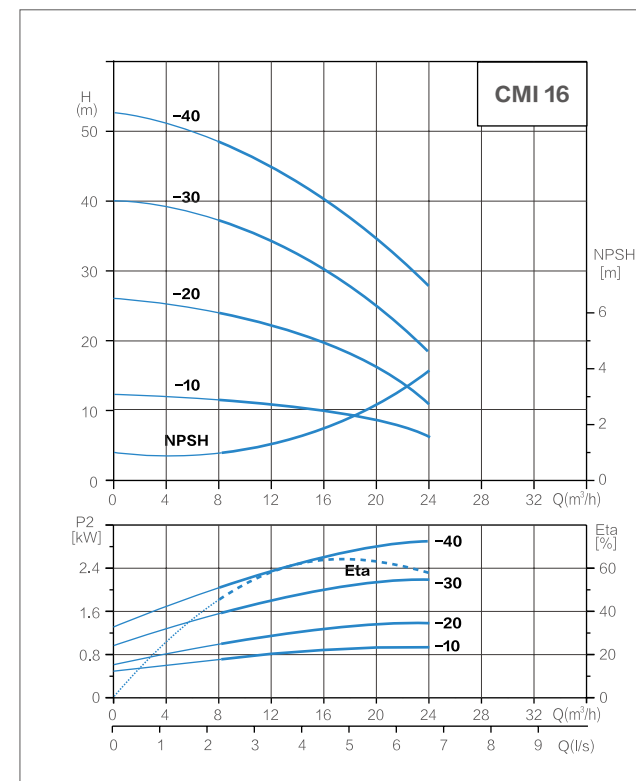
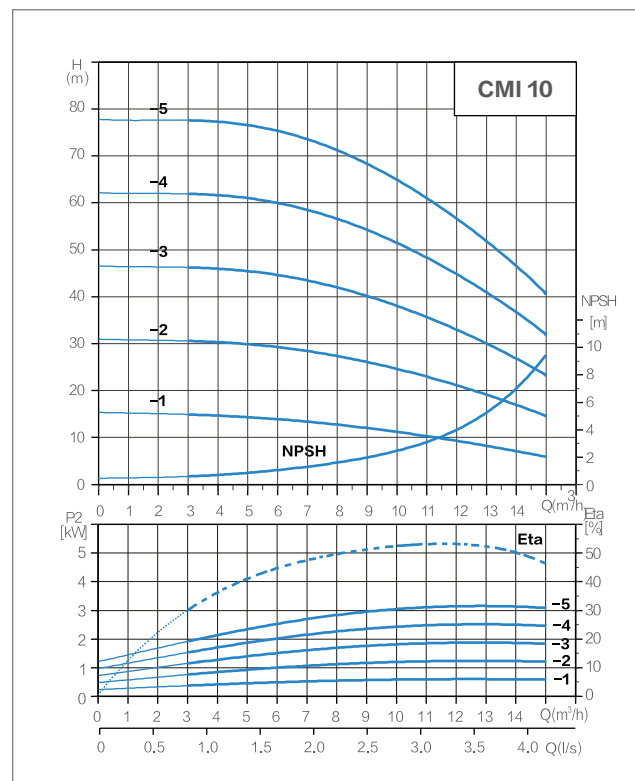
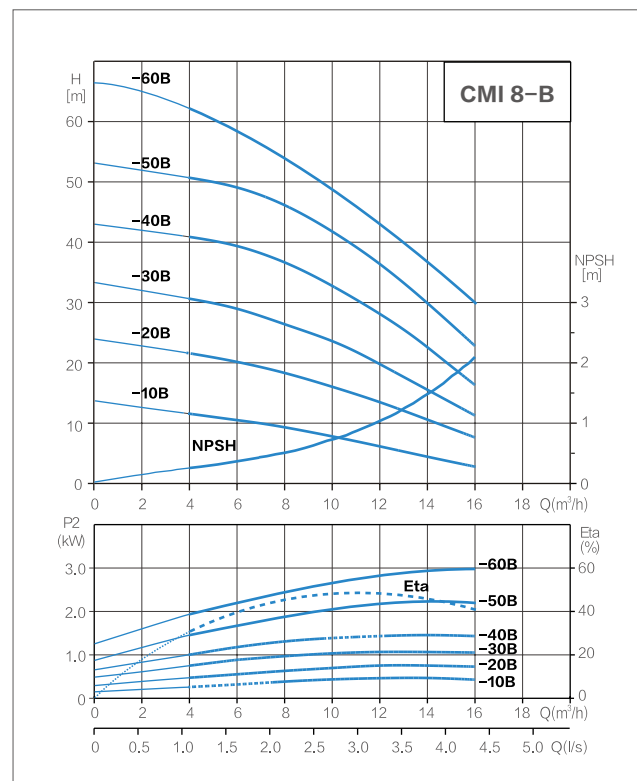
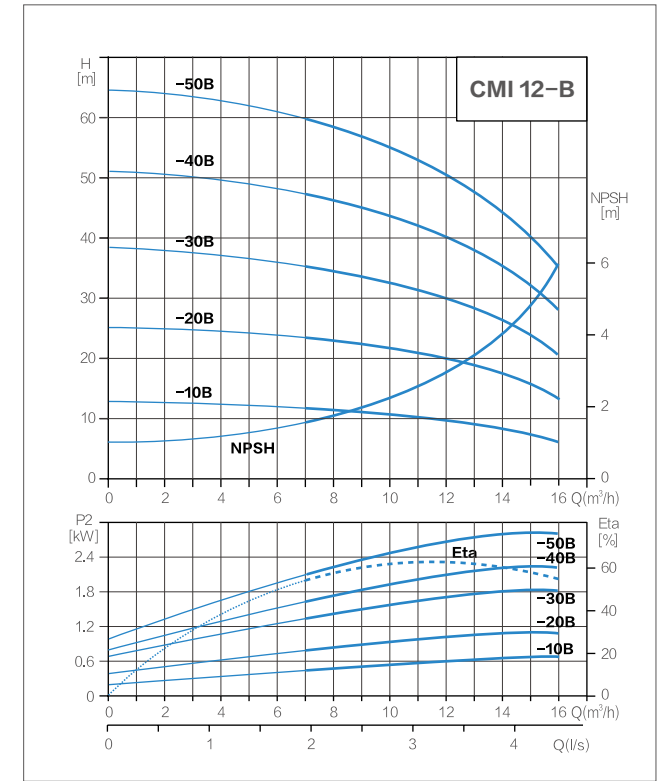
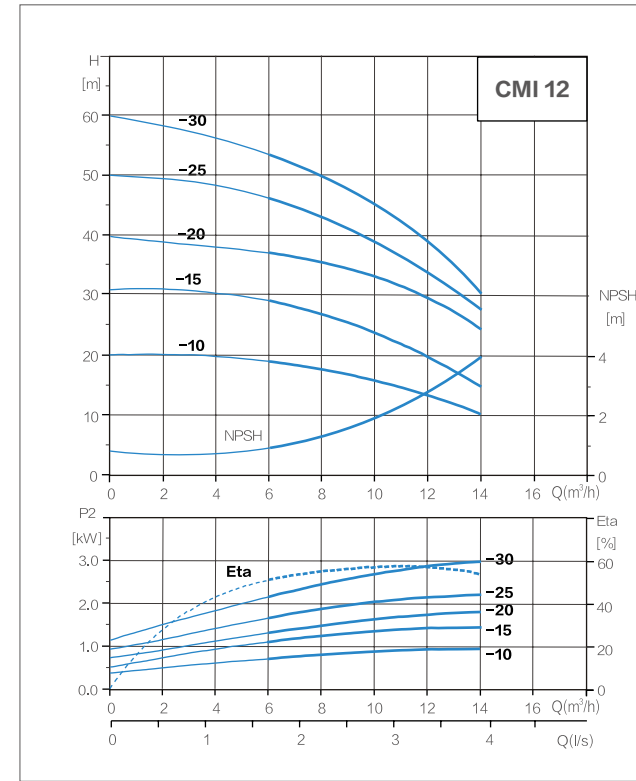

Technical Parameters

No.	Model	Power P2	Rated Flow	Rated Head	Speed	Inlet DIM	Outlet DIM
		KW	Qn (m³/h)	Hn (m)	r/min		
1	CMI1-2(D)	0.25	1	18	2900	G1	G1
2	CMI1-3(D)	0.25	1	25	2900	G1	G1
3	CMI1-4(D)	0.37	1	33	2900	G1	G1
4	CMI1-5(D)	0.37	1	38	2900	G1	G1
5	CMI1-6(D)	0.37	1	46	2900	G1	G1
6	CMI1-7(D)	0.55	1	53	2900	G1	G1
7	CMI2-2(D)	0.25	2	18	2900	G1	G1
8	CMI2-3(D)	0.37	2	24	2900	G1	G1
9	CMI2-4(D)	0.55	2	32	2900	G1	G1
10	CMI2-5(D)	0.55	2	40	2900	G1	G1
11	CMI2-6(D)	0.75	2	47	2900	G1	G1
12	CMI2-7(D)	1	2	57	2900	G1	G1
13	CMI3-2(D)	0.25	3	15	2900	G1	G1
14	CMI3-3(D)	0.37	3	21	2900	G1	G1
15	CMI3-4(D)	0.55	3	28	2900	G1	G1
16	CMI3-5(D)	0.55	3	35	2900	G1	G1
17	CMI3-6(D)	0.75	3	42	2900	G1	G1
18	CMI3-7(D)	1	3	49	2900	G1	G1
19	CMI4-2(D)	0.37	4	15.5	2900	G11/4	G1
20	CMI4-3(D)	0.55	4	22.5	2900	G11/4	G1
21	CMI4-4(D)	0.75	4	31	2900	G11/4	G1
22	CMI4-5(D)	0.75	4	38	2900	G11/4	G1
23	CMI4-6(D)	1	4	46	2900	G11/4	G1
24	CMI4-7(D)	1.1	4	53	2900	G11/4	G1
25	CMI5-2(D)	0.37	5	13	2900	G11/4	G1
26	CMI5-3(D)	0.55	5	19.5	2900	G11/4	G1
27	CMI5-4(D)	0.75	5	26	2900	G11/4	G1
28	CMI5-5(D)	0.75	5	32	2900	G11/4	G1
29	CMI5-6(D)	1	5	39.5	2900	G11/4	G1
30	CMI5-7(D)	1.1	5	45.5	2900	G11/4	G1
31	CMI8-10(D)	0.55	8	10	2900	G11/2	G11/2
32	CMI8-15(D)	0.75	8	17	2900	G11/2	G11/2
33	CMI8-20(D)	1	8	20	2900	G11/2	G11/2

Technical Parameters

No.	Model	Power P2	Rated Flow	Rated Head	Speed	Inlet DIM	Outlet DIM
		KW	Qn (m³/h)	Hn (m)	r/min		
34	CMI8-25(D)	1.5	8	30	2900	G11/2	G11/2
35	CMI8-30(D)	1.85	8	32	2900	G11/2	G11/2
36	CMI8-35(D)	2.2	8	42	2900	G11/2	G11/2
37	CMI8-40(D)	2.2	8	45	2900	G11/2	G11/2
38	CMI8-10B(D)	0.55	8	10	2900	G11/2	G11/2
39	CMI8-20B(D)	0.75	8	18	2900	G11/2	G11/2
40	CMI8-30B(D)	1.1	8	26	2900	G11/2	G11/2
41	CMI8-40B(D)	1.5	8	34	2900	G11/2	G11/2
42	CMI8-50B(D)	2.2	8	45	2900	G11/2	G11/2
43	CMI8-60B	3	8	52	2900	G11/2	G11/2
44	CMI10-1(D)	0.65	10	11	2900	G11/2	G11/2
45	CMI10-2(D)	1.2	10	24	2900	G11/2	G11/2
46	CMI10-3(D)	2.2	10	38	2900	G11/2	G11/2
47	CMI10-4	3	10	52	2900	G11/2	G11/2
48	CMI10-5	3	10	63	2900	G11/2	G11/2
49	CMI12-10(D)	1	12	12.5	2900	G11/2	G11/2
50	CMI12-15(D)	1.5	12	19	2900	G11/2	G11/2
51	CMI12-20(D)	1.85	12	26	2900	G11/2	G11/2
52	CMI12-25(D)	2.2	12	32	2900	G11/2	G11/2
53	CMI12-30	3	12	40	2900	G11/2	G11/2
54	CMI12-10B(D)	0.75	12	8.5	2900	G11/2	G11/2
55	CMI12-20B(D)	1.1	12	19.5	2900	G11/2	G11/2
56	CMI12-30B(D)	1.85	12	29.5	2900	G11/2	G11/2
57	CMI12-40B(D)	2.2	12	39.5	2900	G11/2	G11/2
58	CMI12-50B	3	12	50	2900	G11/2	G11/2
59	CMI16-10(D)	1	16	10	2900	G2	G2
60	CMI16-20(D)	1.5	16	20	2900	G2	G2
61	CMI16-30(D)	2.2	16	30	2900	G2	G2
62	CMI16-40	3	16	40	2900	G2	G2
63	CMI20-10(D)	1	20	8	2900	G2	G2
64	CMI20-20(D)	1.85	20	18	2900	G2	G2
65	CMI20-30	3	20	28	2900	G2	G2
66	CMI20-40	4	20	42	2900	G2	G2

Installation Dimension

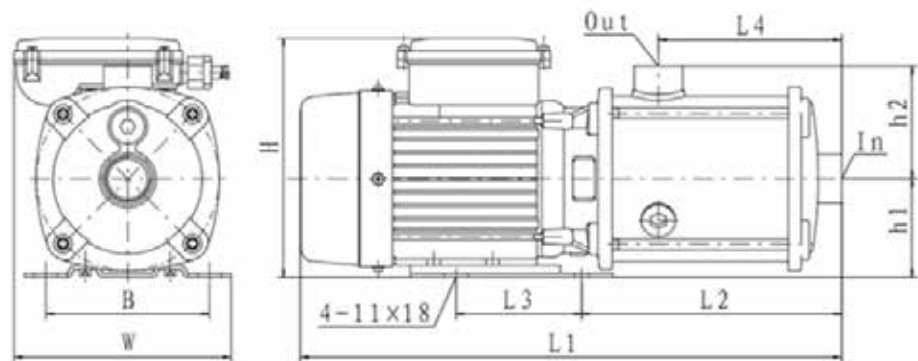

No.	Model	Single Phase					Three Phase					L2	L4	h1	h2	In	Out
		L1	L3	B	W	H	L1	L3	B	W	H						
1	CMI1-2(D)	314	96	125	166	172	314	96	125	158	174	127	68	75	86	G1	G1
2	CMI1-3(D)	314	96	125	166	172	314	96	125	158	174	127	68	75	86	G1	G1
3	CMI1-4(D)	332	96	125	166	172	332	96	125	158	174	145	86	75	86	G1	G1
4	CMI1-5(D)	350	96	125	166	172	350	96	125	158	174	163	104	75	86	G1	G1
5	CMI1-6(D)	386	96	125	166	172	386	96	125	158	174	199	140	75	86	G1	G1
6	CMI1-7(D)	414	96	125	166	182	414	96	125	158	188	199	140	75	86	G1	G1
7	CMI2-2(D)	314	96	125	166	172	314	96	125	158	174	127	68	75	86	G1	G1
8	CMI2-3(D)	314	96	125	166	172	314	96	125	158	174	127	68	75	86	G1	G1
9	CMI2-4(D)	332	96	125	166	172	332	96	125	158	174	145	86	75	86	G1	G1
10	CMI2-5(D)	350	96	125	166	172	350	96	125	158	174	163	104	75	86	G1	G1
11	CMI2-6(D)	414	96	125	166	182	414	96	125	158	188	199	140	75	86	G1	G1
12	CMI2-7(D)	414	96	125	172	185	414	96	125	158	188	199	140	75	86	G1	G1
13	CMI3-2(D)	314	96	125	166	172	314	96	125	158	174	127	68	75	86	G1	G1
14	CMI3-3(D)	314	96	125	166	172	314	96	125	158	174	127	68	75	86	G1	G1
15	CMI3-4(D)	332	96	125	166	172	332	96	125	158	174	145	86	75	86	G1	G1
16	CMI3-5(D)	350	96	125	166	172	350	96	125	158	174	163	104	75	86	G1	G1
17	CMI3-6(D)	414	96	125	166	182	414	96	125	158	188	199	140	75	86	G1	G1
18	CMI3-7(D)	414	96	125	172	185	414	96	125	158	188	199	140	75	86	G1	G1
19	CMI4-2(D)	314	96	125	166	172	314	96	125	158	174	127	68	75	86	G11/4	G1
20	CMI4-3(D)	314	96	125	166	172	314	96	125	158	174	127	68	75	86	G11/4	G1
21	CMI4-4(D)	360	96	125	166	182	360	96	125	158	188	145	86	75	86	G11/4	G1
22	CMI4-5(D)	378	96	125	166	182	378	96	125	158	188	163	104	75	86	G11/4	G1
23	CMI4-6(D)	414	96	125	172	185	414	96	125	158	188	199	140	75	86	G11/4	G1
24	CMI4-7(D)	414	96	125	172	185	414	96	125	158	188	199	140	75	86	G11/4	G1
25	CMI5-2(D)	314	96	125	166	172	314	96	125	158	174	127	68	75	86	G11/4	G1
26	CMI5-3(D)	314	96	125	166	172	314	96	125	158	174	127	68	75	86	G11/4	G1
27	CMI5-4(D)	360	96	125	166	182	360	96	125	158	188	145	86	75	86	G11/4	G1
28	CMI5-5(D)	378	96	125	166	182	378	96	125	158	188	163	104	75	86	G11/4	G1

Installation Dimension

No.	Model	Single Phase					Three Phase					L2	L4	h1	h2	In	Out
		L1	L3	B	W	H	L1	L3	B	W	H						
29	CMI5-6(D)	414	96	125	172	185	414	96	125	158	188	199	140	75	86	G11/4	G1
30	CMI5-7(D)	414	96	125	172	185	414	96	125	158	188	199	140	75	86	G11/4	G1
31	CMI8-10(D)	377	96	125	182	206	377	96	125	182	212	185	100	100	108	G11/2	G11/2
32	CMI8-15(D)	377	96	125	182	206	377	96	125	182	212	185	100	100	108	G11/2	G11/2
33	CMI8-20(D)	377	96	125	184	206	377	96	125	182	212	185	100	100	108	G11/2	G11/2
34	CMI8-25(D)	408	96	125	182	232	408	96	125	182	217	200	100	100	108	G11/2	G11/2
35	CMI8-30(D)	449	140	160	199	244	408	96	125	182	217	200	100	100	108	G11/2	G11/2
36	CMI8-35(D)	479	140	160	199	244	438	96	125	182	217	230	130	100	108	G11/2	G11/2
37	CMI8-40(D)	479	140	160	199	244	438	96	125	182	217	230	130	100	108	G11/2	G11/2
38	CMI8-10B(D)	377	96	125	182	206	377	96	125	182	212	185	100	100	108	G11/2	G11/2
39	CMI8-20B(D)	377	96	125	182	206	377	96	125	182	212	185	100	100	108	G11/2	G11/2
40	CMI8-30B(D)	408	96	125	184	214	408	96	125	182	217	200	100	100	108	G11/2	G11/2
41	CMI8-40B(D)	438	96	125	182	232	438	96	125	182	217	230	130	100	108	G11/2	G11/2
42	CMI8-50B(D)	539	140	160	199	244	498	96	125	182	217	290	190	100	108	G11/2	G11/2
43	CMI8-60B	-	-	-	-	-	559	140	160	199	212	290	190	100	108	G11/2	G11/2
44	CMI10-1(D)	383	96	125	182	206	383	96	125	182	212	185	100	100	108	G11/2	G11/2
45	CMI10-2(D)	412	96	125	184	214	412	96	125	182	217	200	100	100	108	G11/2	G11/2
46	CMI10-3(D)	448	140	160	199	244	448	140	160	199	212	200	100	100	108	G11/2	G11/2
47	CMI10-4	-	-	-	-	-	498	140	160	199	212	230	130	100	108	G11/2	G11/2
48	CMI10-5	-	-	-	-	-	558	140	160	199	212	230	190	100	108	G11/2	G11/2
49	CMI12-10(D)	377	96	125	184	206	377	96	125	182	212	185	100	100	108	G11/2	G11/2
50	CMI12-15(D)	408	96	125	182	232	408	96	125	182	217	200	100	100	108	G11/2	G11/2
51	CMI12-20(D)	449	140	160	199	244	408	96	125	182	217	200	100	100	108	G11/2	G11/2
52	CMI12-25(D)	449	140	160	199	244	408	96	125	182	217	200	100	100	108	G11/2	G11/2
53	CMI12-30	-	-	-	-	-	469	140	160	199	212	200	100	100	108	G11/2	G11/2
54	CMI12-10B(D)	377	96	125	182	206	377	96	125	182	212	185	100	100	108	G11/2	G11/2
55	CMI12-20B(D)	408	96	125	184	214	408	96	125	182	217	200	100	100	108	G11/2	G11/2
56	CMI12-30B(D)	449	140	160	199	244	408	96	125	182	217	200	100	100	108	G11/2	G11/2
57	CMI12-40B(D)	479	140	160	199	244	438	96	125	182	217	230	130	100	108	G11/2	G11/2
58	CMI12-50B	-	-	-	-	-	539	140	160	199	212	290	190	100	108	G11/2	G11/2
59	CMI16-10(D)	408	96	125	184	209	408	96	125	182	212	215	130	100	108	G2	G2
60	CMI16-20(D)	439	96	125	182	232	439	96	125	182	217	230	130	100	108	G2	G2
61	CMI16-30(D)	480	140	160	199	244	480	140	160	199	212	230	130	100	108	G2	G2
62	CMI16-40	-	-	-	-	-	545	140	160	199	212	275	175	100	108	G2	G2
63	CMI20-10(D)	408	96	125	184	209	408	96	125	182	212	215	130	100	108	G2	G2
64	CMI20-20(D)	480	140	160	182	244	439	96	125	182	217	230	130	100	108	G2	G2
65	CMI20-30	-	-	-	-	-	500	140	160	199	212	230	130	100	108	G2	G2
66	CMI20-40	-	-	-	-	-	561	140	160	199	252	297	175	105	108	G2	G2

MHI

Horizontal Multistage Stainless Steel Pump



Private House



Civil use



Industrial use



Main Application

- Water supply and pressure boosting
- Hot water circulation and heating system
- Air-conditioning systems
- Industrial circulation systems
- Washing and sprinkling systems
- For various machinery

Feature

- Stainless steel materials
- High pressure by multi-stage impeller

Material

Casing	AISI 304
Impeller	AISI 304
Shaft	AISI 304
Mechanical seal	Silicon carbide & American Morgan graphite with temperature resistance of 120°C and resistance to antifreeze corrosion
Bearing	Customized high-temperature resistant grease (-50 ~ 200°C), high speed silent bearing
Motor	National standard silicon steel stator and rotor, F-grade high-temperature resistant insulated copper wire

Technical Data

Model	MHI-202	MHI-203	MHI-204	MHI-205	MHI-206	MHI-402	MHI-403	MHI-404	MHI-405	MHI-406	MHI-802	MHI-803	MHI-804	MHI-805	MHI-1602	MHI-1603	MHI-1604
Electrical connection																	
Power source	220V/50Hz, 380V/50Hz																
Power(kW)	0.37	0.55	0.55	0.75	1.1	0.37	0.55	0.75	1.1	1.5	0.75	1.1	1.5	1.85	1.5	1.85	2.2
Application situation																	
Approved Fluids	Clean water																
Fluid temp (°C)	0 ~ 90																
Performance parameter																	
Max. head(m)	22	33	45	54	69	23	33	42	57	68	23	36	48	59	24	36	48
Rated head(m)	20	30	38	47	60	18	27	38	46	55	17	24	35	47	16	27	33
Max. flow(m³/h)	5	5	5	5	5	8	8	8	8	8	12	12	12	12	26	26	26
Rated flow(m³/h)	2	2	2	2	2	4	4	4	4	4	8	8	8	8	16	16	16
Inlet size(DN)	25	25	25	25	25	32	32	32	32	32	40	40	40	40	50	50	50
Outlet size(DN)	25	25	25	25	25	25	25	25	25	25	32	32	32	32	40	40	40
Max. pressure(bar)	10																
Protection class	IP54																

Hydraulic Performance Curves

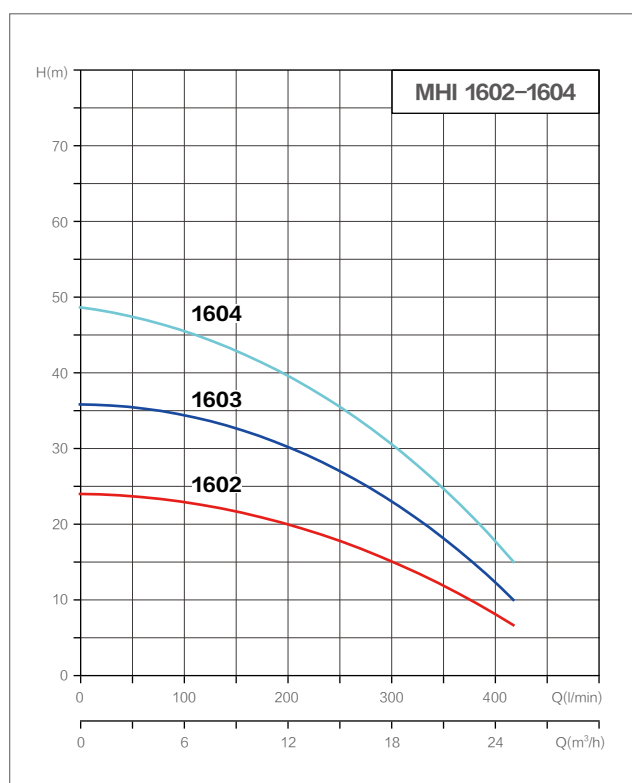
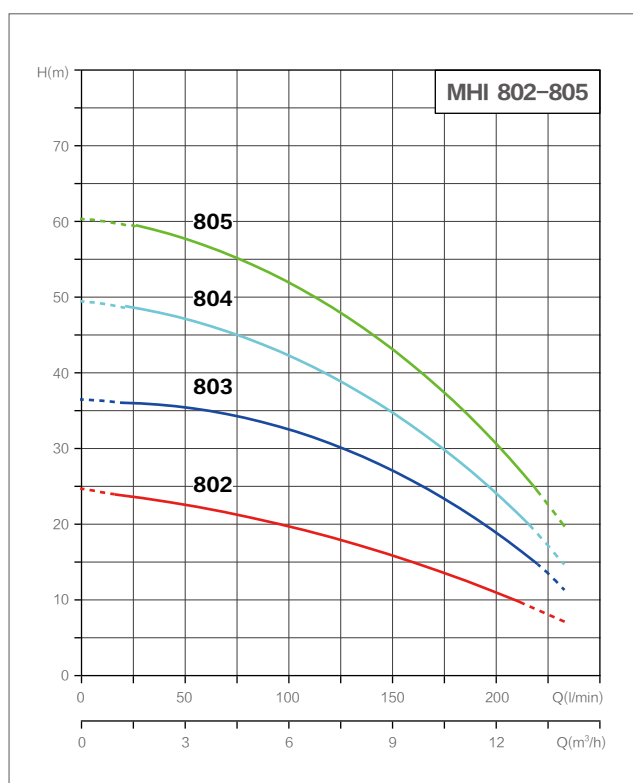
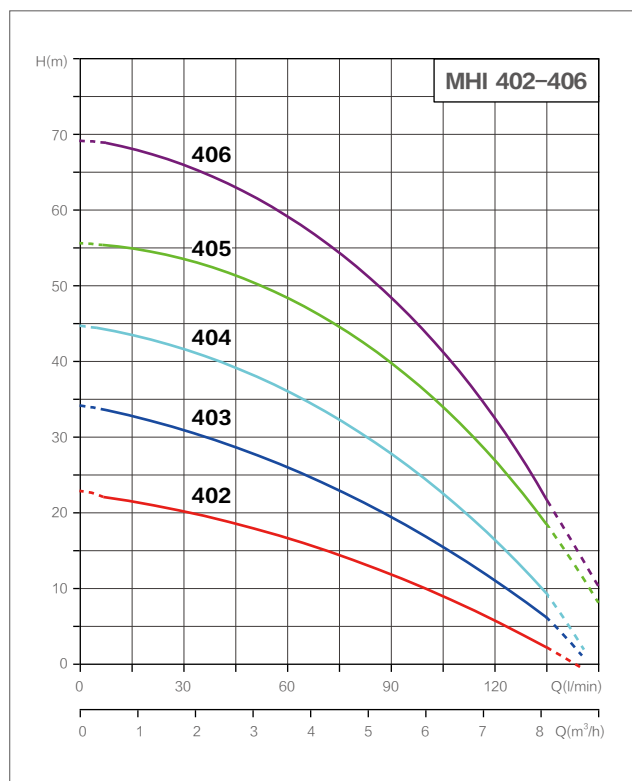
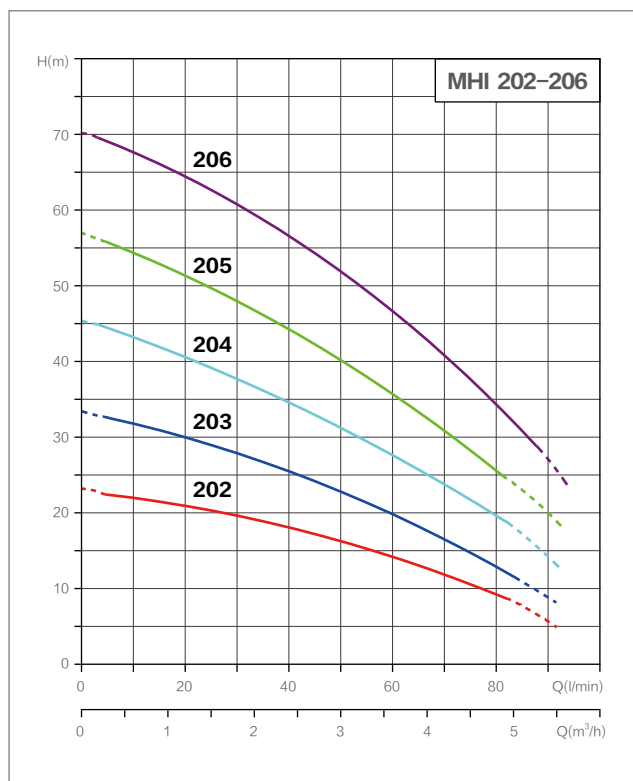

Dimensional Drawing

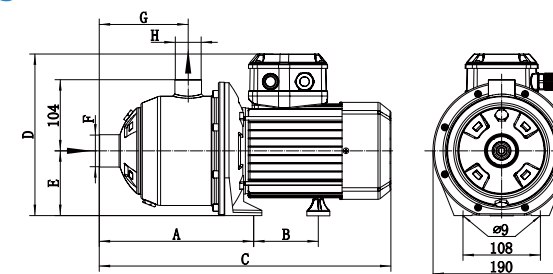

Model	A	B		C		D		E		F	G	H
		1~220V	3~380V	1~220V	3~380V	1~220V	3~380V	1~220V	3~380V			
MHI202	205	70	70	377	377	206	225	90	90	Rp1	110	Rp1
MHI203	205	88	70	418	377	206	225	90	90	Rp1	110	Rp1
MHI204	229	88	88	418	418	206	225	90	90	Rp1	134	Rp1
MHI205	253	88	88	442	442	206	225	90	90	Rp1	158	Rp1
MHI206	277	88	88	474	466	206	225	90	90	Rp1	182	Rp1
MHI402	205	70	70	377	377	206	225	90	90	Rp1 1/4	110	Rp1
MHI403	205	88	88	418	418	206	225	90	90	Rp1 1/4	110	Rp1
MHI404	229	88	88	442	442	206	225	90	90	Rp1 1/4	134	Rp1
MHI405	253	88	88	474	474	206	225	90	90	Rp1 1/4	158	Rp1
MHI406	277	106	88	498	498	232	225	90	90	Rp1 1/4	182	Rp1
MHI802	217	88	88	406	406	206	225	90	90	Rp1 1/2	122	Rp1 1/4
MHI803	217	88	88	436	444	206	225	90	90	Rp1 1/2	122	Rp1 1/4
MHI804	247	106	88	450	474	232	225	90	90	Rp1 1/2	152	Rp1 1/4
MHI805	277	-	106	-	480	-	237	-	90	Rp1 1/2	182	Rp1 1/4
MHI1602	237	-	106	-	440	-	237	-	90	Rp2	138	Rp1 1/2
MHI1603	237	-	106	-	440	-	237	-	90	Rp2	138	Rp1 1/2
MHI1604	282	-	147	-	529	-	270	-	90	Rp2	138	Rp1 1/2

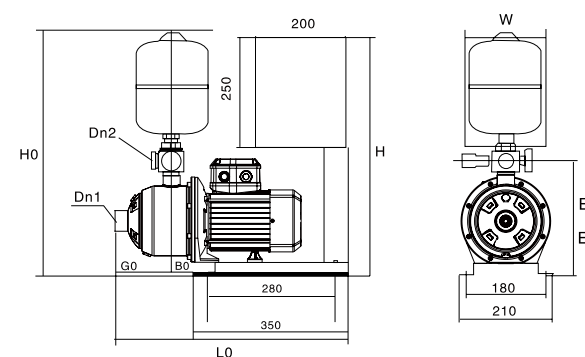

Model	Rated Power (kW)	DN1	DN2	E0	G0	B0	L0	H0	H	W	Pressure Setting (bar)
BF-MHI202	0.37	25	25	120	138	80	505	541	540	180	1.6
BF-MHI203	0.55	25	25	120	138	80	505	541	540	180	2.4
BF-MHI402	0.55	25	32	120	138	80	505	541	540	180	1.6
BF-MHI403	0.55	25	32	120	138	80	505	541	540	180	2.4
BF-MHI404	0.75	25	32	120	138	80	553	541	540	180	3.0
BF-MHI405	1.1	25	32	120	138	80	553	541	540	180	4.0
BF-MHI406	1.5	25	32	130	138	80	577	551	540	180	5.0
BF-MHI802	0.75	32	40	120	144	80	517	552	540	180	1.6
BF-MHI803	1.1	32	40	120	144	80	517	552	540	180	2.4
BF-MHI804	1.5	32	40	130	144	80	517	562	540	180	3.0
BF-MHI805	1.85	32	40	130	144	80	517	562	540	180	4.0
BF-MHI1602	1.5	40	50	120	154	84	537	562	540	180	1.6
BF-MHI1603	1.85	40	50	120	154	84	537	562	540	180	2.4
BF-MHI1604	2.2	40	50	130	154	84	582	572	590	210	3.0

PUN

Centrifugal Booster Pump



Private House



Civil use



Centrifugal Booster Pump



Main Application

- For various machinery
- General water supply for house, garden
- Small HVAC circulation system

Feature

- Low flow at high head
- Compact design

Material

Casing	Salt spray resistant electrophoretic rust prevention for precision steel casting
Impeller	Modified PPO high-temperature and wear-resistant engineering plastic/stainless steel
Shaft	AISI 304
Mechanical seal	Silicon carbide & Morgan graphite from the United States has a temperature resistance of 120°C , dry grinding for more than 3 hours, and is resistant to antifreeze corrosion
Bearing	Customized high-temperature resistant grease (-50~200°C), high speed silent bearing
Motor	National standard silicon steel stator and rotor, F-grade high-temperature resistant insulated copper wire

Technical Data

Model	PUN-201EH	PUN-301EH	PUN-402EH	PUN-403EH	PUN-601EH	PUN-750EH	PUN-751EH	PUN-1100EH	PUN-1500EH
Power source	220V/50Hz								
Input Power P1 (W)	320	550	720	660	880	1100	1250	1500	1950
Output Power P2 (W)	200	370	400	400	600	750	750	1100	1500
Application situation									
Approved Fluids	Clean water								
Fluid temp (°C)	0 ~ 90								
Performance parameter									
Max. flow(m³/h)	5	5.3	6.5	6.5	7.5	12	7.5	16	28
Max. head(m)	16	20	23	23	28	26	32	30	24
Rated flow(m³/h)	3	3	4	4	4	6.6	5	8	16
Rated head(m)	10	15	16	16	20	18	20	23	20
Inlet size(DN)	25	25	32	25	25	32	32	40	40
Outlet size(DN)	25	25	32	25	25	32	32	40	40
Max. pressure(bar)	5	5	5	5	5	4	4	4	4
Protection class	IP54								
Weight (kg)	7	9	10	10	11.5	12.5	13	19	21

Hydraulic Performance Curves

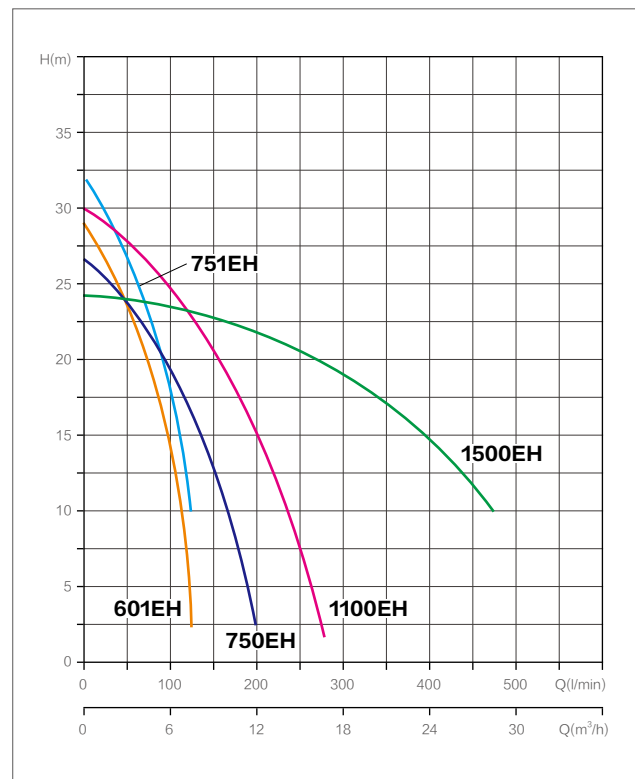
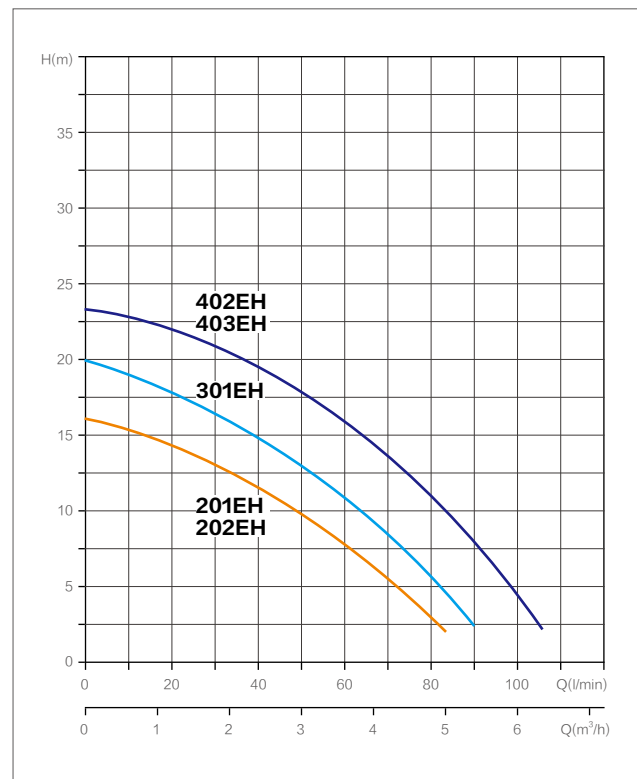

Dimensional Drawing

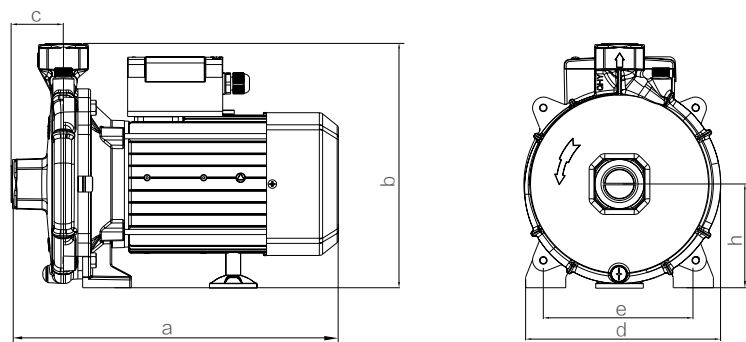

Model	a	b	c	d	e	h
PUN201EH	255	194	45	142	104	75
PUN401EH	280	196	45	159	104	81
PUN402/402EH	281	220	40	172	124	95
PUN601EH	307	230	47	180	140	98
PUN750EH	327	233	53	183	140	98
PUN751EH	320	235	46	183	140	98
PUN1100EH	348	254	52	188	140	103
PUN1500EH	355	246	59	185	140	103

PH

Small Pipe Pump



Private House



Civil use



Industrial use



Main Application

- Hot water circulation and heating system
- Air-conditioning system
- Industrial circulation system
- Water supply and boosting

Feature

- In-line , easy installation
- Light and excellent design
- Long life

Material

Casing	Salt spray resistant electrophoretic rust prevention for precision steel casting
Impeller	Modified PPO high-temperature and wear-resistant engineering plastic/stainless steel
Shaft	AISI 304
Mechanical seal	Silicon carbide & Morgan graphite from the United States has a temperature resistance of 120°C , dry grinding for more than 3 hours, and is resistant to antifreeze corrosion
Bearing	Customized high-temperature resistant grease (-50~200°C), high speed silent bearing
Motor	National standard silicon steel stator and rotor, F-grade high-temperature resistant insulated copper wire

Technical Data

Model	PH-043EH	PH-102EH	PH-150EH	PH-255EH	PH-256EH	PH-257EH	PH-751EH	PH-752EH	PH-751QH	PH-752QH	PH-1501QH	PH-2201QH
Power source	220V/50Hz						380V/50Hz					
Input Power P1 (W)	90	150	220	330	450	450	1050	1050	900	900	1750	2800
Output Power P2 (W)	40	120	125	250	370	370	750	750	750	750	1500	2200
Application situation												
Approved Fluids	Clean water											
Fluid temp (°C)	0 ~ 100											
Performance parameter												
Max. flow(m³/h)	3.6	10	15	6.5	17.5	17.5	18	18	18	18	25	28
Max. head(m)	3.5	6	5	15	8	8	20	20	20	20	25	30
Rated flow(m³/h)	2	6	11	3	14	14	7.8	7.8	7.8	7.8	16	18.5
Rated head(m)	2.5	4	3	10	4	4	16	16	16	16	15	20
Inlet size(DN)	25	40	50	40	65	50	50	65	50	65	50	50
Outlet size(DN)	25	40	50	40	65	50	50	65	50	65	50	50
Max. pressure(bar)	5.0	5.0	5.0	5.0	5.0	5.0	5.0	5.0	5.0	5.0	5.0	5.0
Protection class	IP44											
Weight (kg)	3.7	8	10.5	9	16	16	20	20	20	20	32	34

Hydraulic Performance Curves

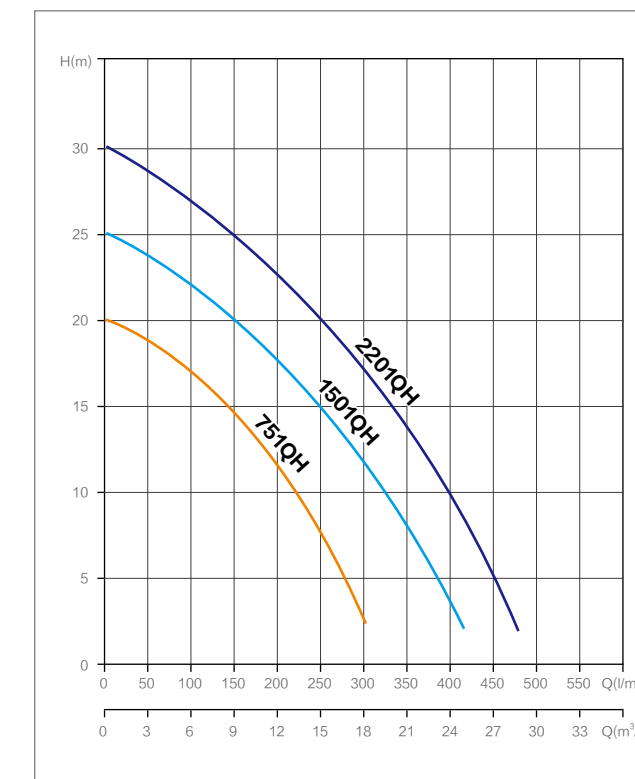
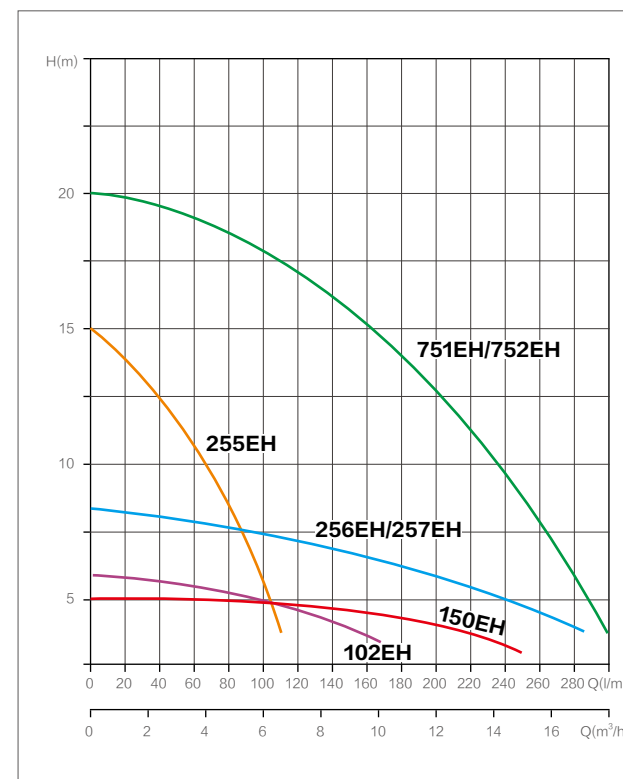

Dimensional Drawing

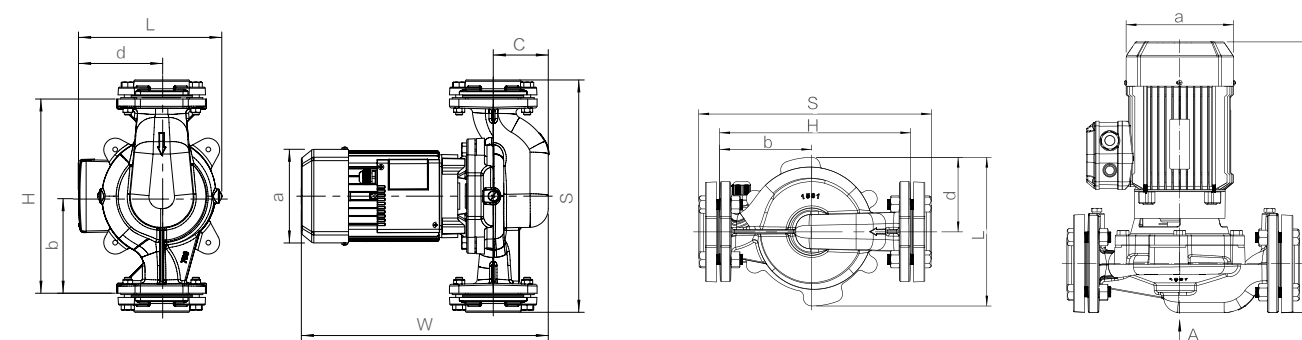

Model	W	L	H	S	a	b	c	d
PH102EH	270	190	210	274	Φ134	105	46	118
PH150EH	302	196	260	311	Φ134	130	69	119
PH255EH	256	194	260	316	Φ134	130	44	118
PH257EH	347	202	280	330	Φ134	140	73	118
PH751EH	353	206	280	330	Φ134	140	78	119

Model	W	L	H	S	a	b	c	d
PH751QH	353	204	280	330	Φ134	140	78	121
PH1501QH	434	268	310	372	Φ172	160	78	150
PH2201QH	434	268	310	372	Φ172	160	78	150

ZW

Direct Coupling Type Self-priming Centrifugal Sewage Pump



Agricultural



Civil use



Industrial use



Product Overview

ZW series self-priming centrifugal sewage pump is a new generation product designed according to the performance parameters specified in the enterprise standard and combined with our many years of production experience. Pump has the advantages of compact structure, small volume, beautiful appearance, small installation area, stable operation, long service life, high efficiency, power consumption, and convenient decoration. It also can be used in parallel and in series according to the need of head and flow. This pump is composed of electric motor, mechanical seal and pump. Motor is single-phase or three-phase asynchronous motor; Mechanical seal is used between the pump and the motor, the rotor shaft of the electric pump is made of high quality carbon steel material and anti-corrosion treatment to ensure that the shaft has more reliable mechanical strength, which can effectively improve the wear resistance and corrosion resistance of the shaft, and also has the convenience of impeller maintenance and disassembly. Pump adopts "O" shaped rubber seal at each fixed stop seal for static sealing.

Main Application

- Application for urban environmental protection, greenhouse sprinkler, construction, fire fighting, chemical industry, pharmaceutical, dyeing and printing, brewing, electric power, electroplating, paper making, petroleum, mining, equipment cooling, etc.
- It can be used with any type and specification of filter press, and it is the most ideal pump to send slurry to filter press for filtering.
- Direct Coupling Type Self-priming Centrifugal Sewage Pump is suitable for sewage discharge in municipal sewage treatment, construction projects, hotels, printing, dyeing, papermaking, textile and other places, and is the ideal equipment for pumping mud, domestic wastewater, sewage, feces and urine and solid particles such as oil-containing fiber, paper dust, mud and sand.

Model Implication

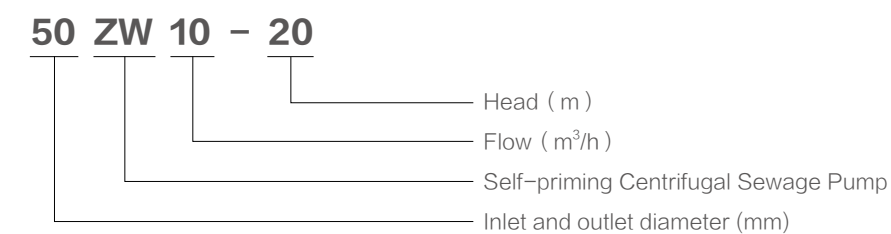

Hydraulic Performance Curves

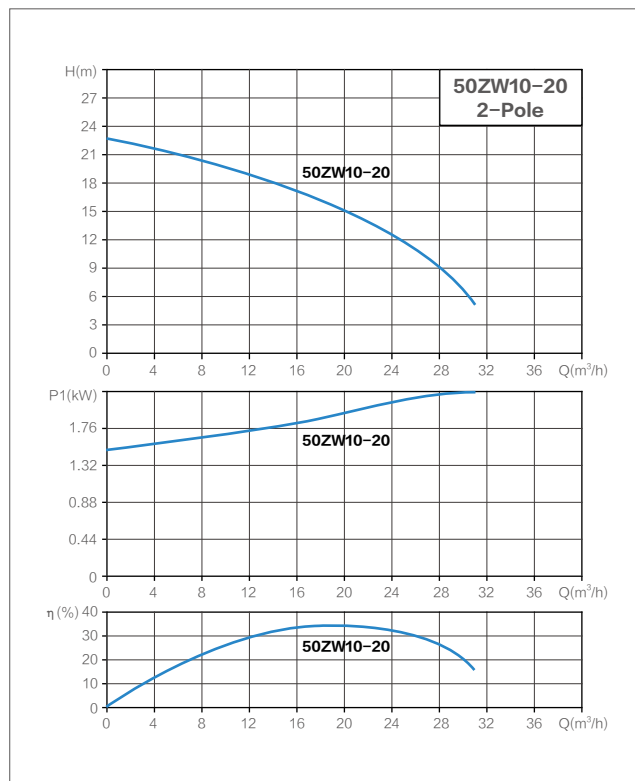
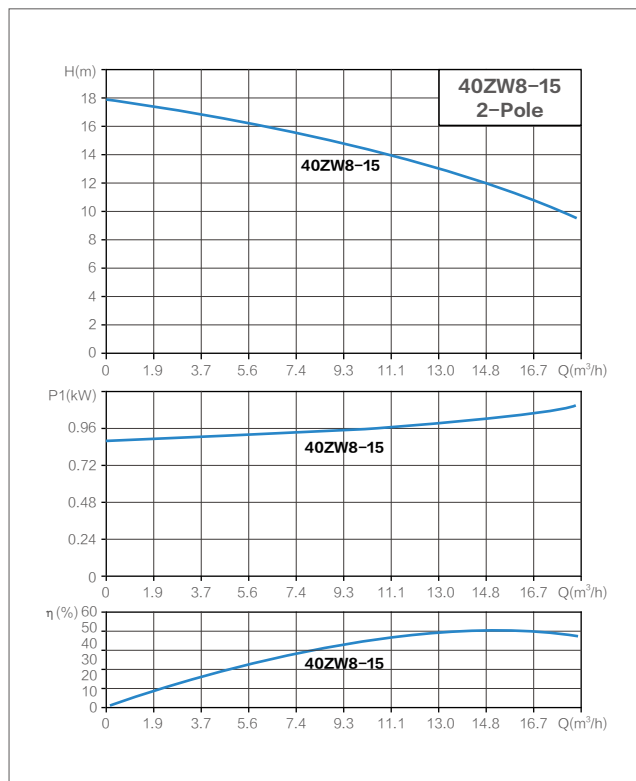

Hydraulic Performance Curves

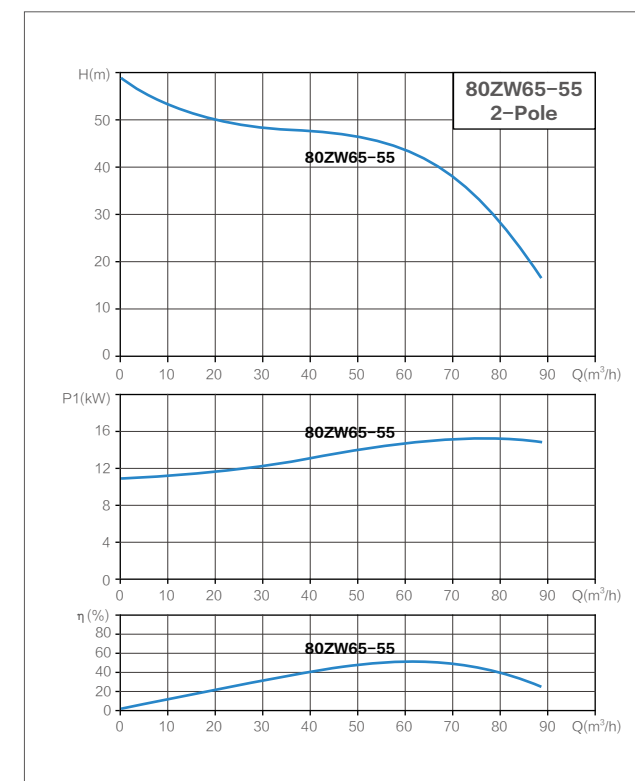
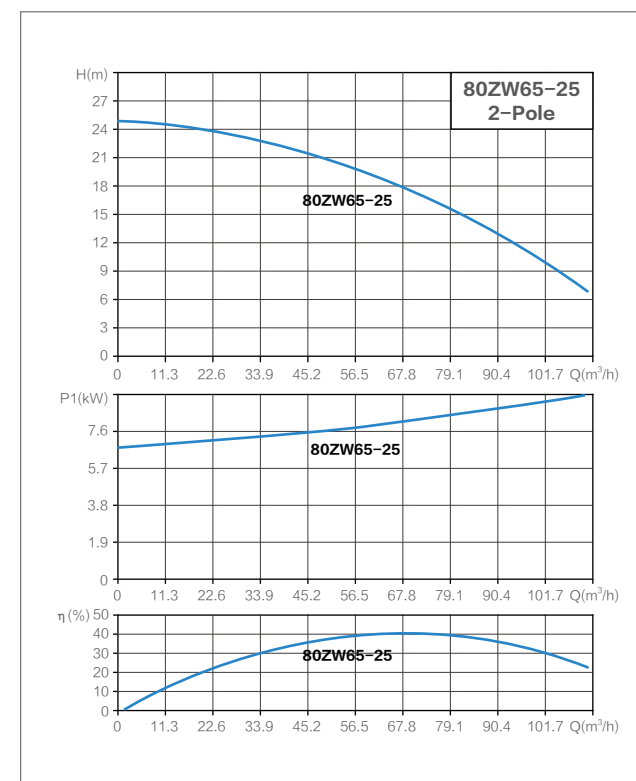
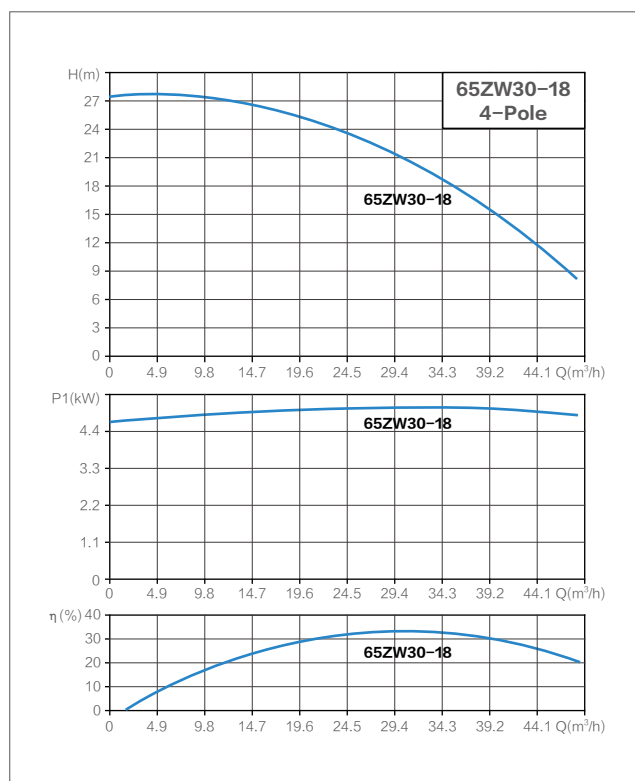
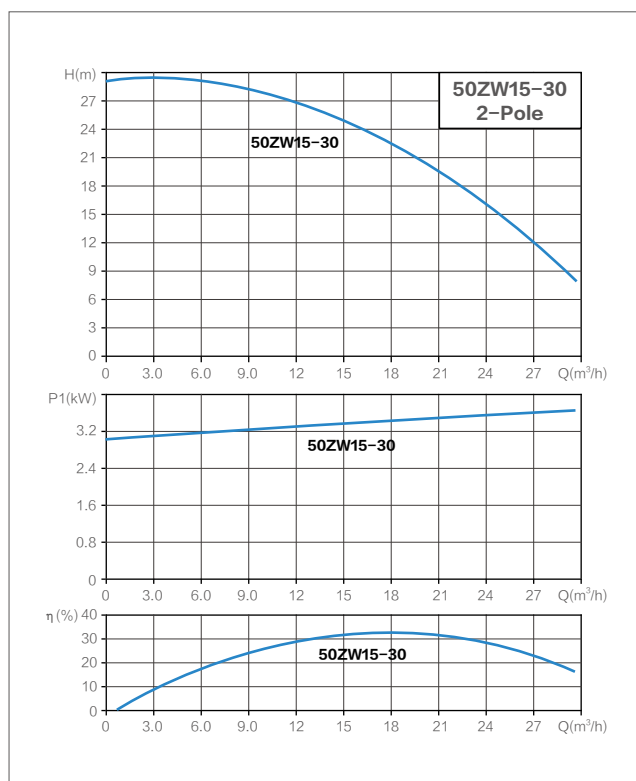
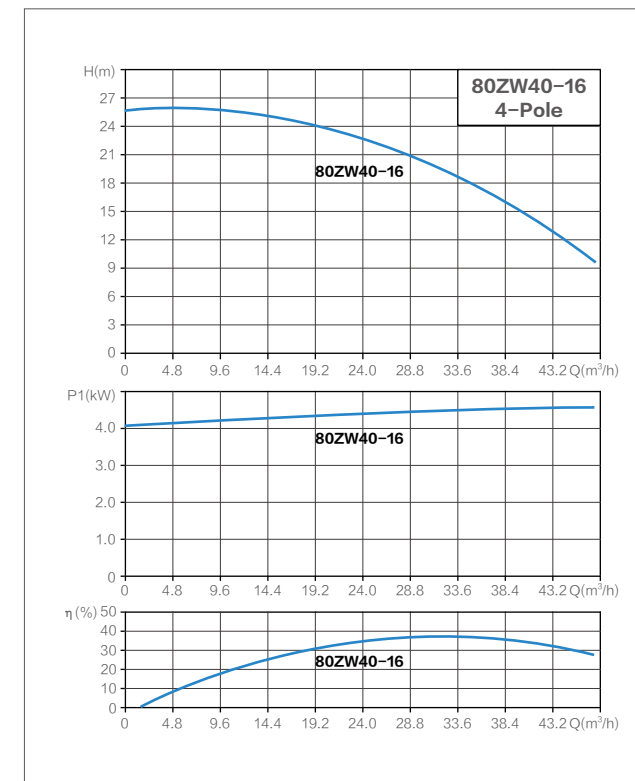
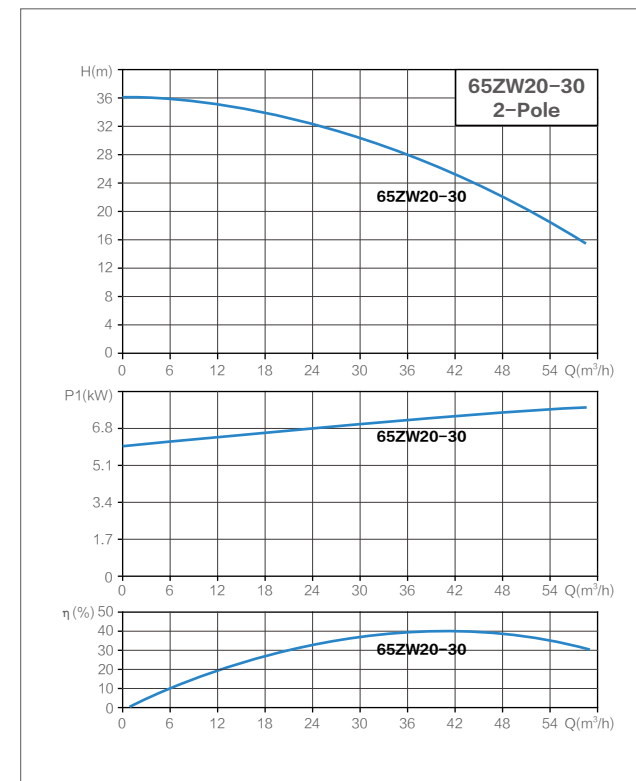

Hydraulic Performance Curves

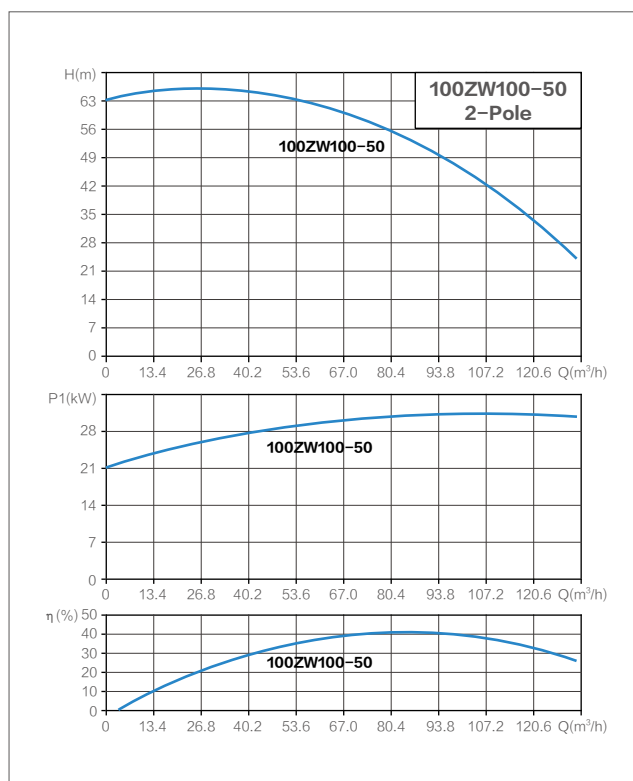
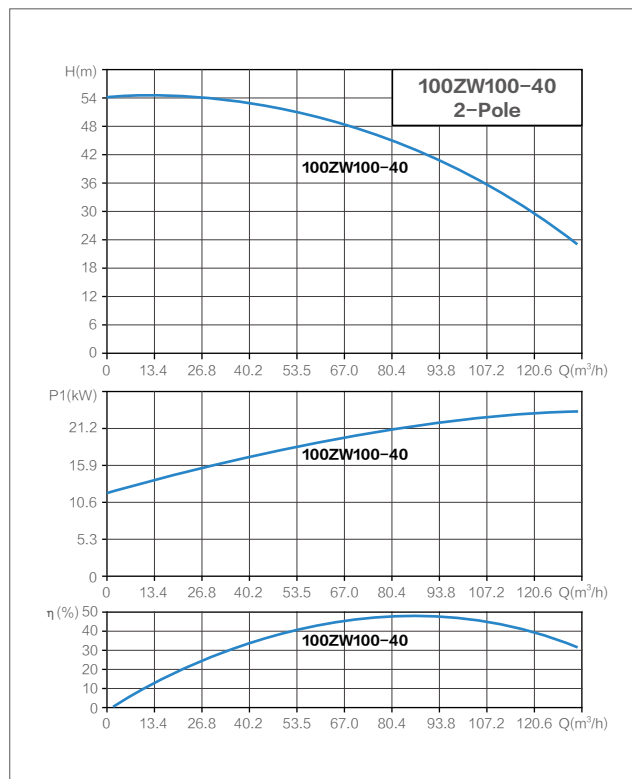
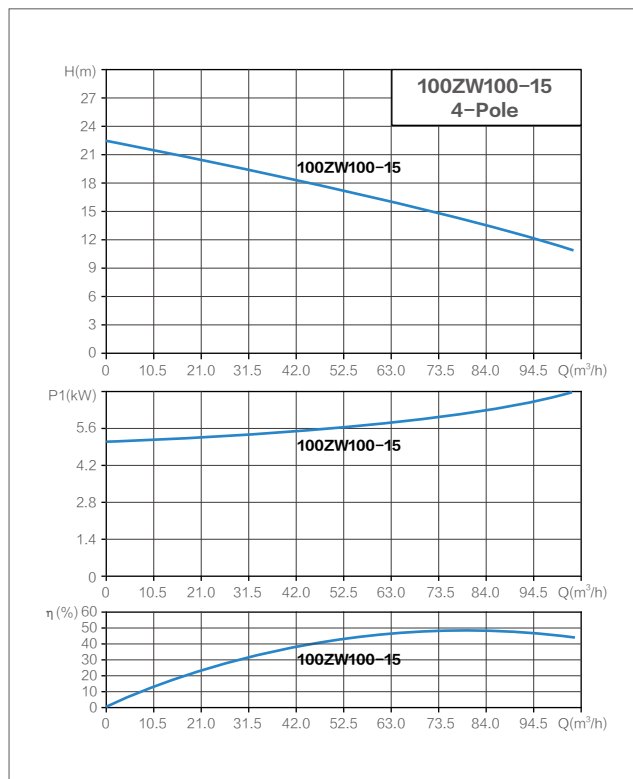

Struture:

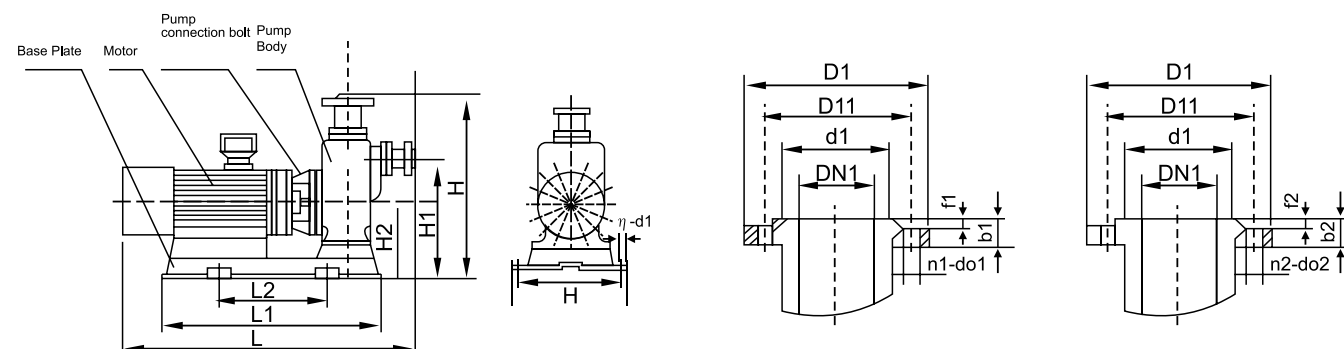

Technical Parameter

Model	Flow	Head	Eff.	Speed	Power	Passing Capacity		Self-suction height	Appearance size			Installation Dimension					Shock absorber specification		
	m³/h	m	%	r/min	kW	HP	Solid Diameter		Fiber length	m	L	H	B	L1	L2	H1		H2	B1
40ZW8-15	8	15	55	2900	1.5	2	25	220	6	520	425	300	460	340	275	170	355	4-Φ16	JGD1
50ZW40-20	10	20	58	2900	2.2	3	30	230	6	600	475	300	460	340	290	180	355	4-Φ16	JGD1
50ZW15-30	15	30	60	2900	3	4	30	250	6	690	520	350	510	280	340	185	390	4-Φ18	JGD1
65ZW30-18	30	18	60	1450	4	5.5	40	380	6	800	620	410	540	320	430	220	350	4-Φ16	JGD2
65ZW20-30	20	30	60	2900	5.5	7.5	40	350	6	850	670	415	590	340	465	255	350	4-Φ18	JGD2
80ZW40-16	40	16	62	1450	4	5.5	48	400	6	800	620	410	540	320	430	220	350	4-Φ16	JGD2
80ZW65-25	65	25	62	2900	7.5	10	48	400	6	850	670	415	670	435	465	255	435	4-Φ16	JGD2
80ZW65-55	65	55	62	2900	15	20	48	400	6	910	800	500	670	430	530	270	430	4-Φ18	JGD2
100ZW100-15	100	15	65	1450	7.5	10	60	500	6	900	800	500	670	435	530	300	435	4-Φ18	JGD2
100ZW100-40	100	40	66	2900	22	30	70	600	6	1085	820	850	770	530	550	320	360	4-Φ18	JGD2
100ZW100-50	100	50	67	2900	30	40	75	650	6	1135	820	885	810	570	550	320	360	4-Φ18	JGD2

BZ

Self-priming Centrifugal Pump for Clean Water



Agricultural



Civil use



Industrial use



Product Overview

BZ series self-priming clear water pump is a new generation product designed according to the performance parameters specified in the enterprise standard and combined with our many years of production experience. The pump has the advantages of compact structure, small volume, beautiful appearance, small installation area, stable operation, long service life, high efficiency, power consumption, and convenient decoration. It also can be used in parallel and in series according to the need of head and flow.

This pump is composed of electric motor, mechanical seal and pump. Motor is single-phase or three-phase asynchronous motor; Mechanical seal is used between the pump and the motor, the rotor shaft of the electric pump is made of high quality carbon steel material and anti-corrosion treatment to ensure that the shaft has more reliable mechanical strength, which can effectively improve the wear resistance and corrosion resistance of the shaft, and also has the convenience of impeller maintenance and disassembly. This pump adopts "O" shaped rubber seal at each fixed stop seal for static sealing.

Main Application

- Suitable for urban environmental protection, greenhouse sprinkler, construction, fire-fighting, chemical, pharmaceutical, dyeing and dyeing, brewing, electric power, electroplating, paper making, petroleum, mining, equipment cooling, etc.
- It can be used with any type and specification of filter press, and it is the most ideal pump to send the slurry to the filter press for filtering.
- BZ self-priming centrifugal pump is suitable for conveying clear water and other liquids with physical and chemical properties similar to clear water. It is a good machine for farms, nurseries, orchards and tea gardens, as it can disperse water into fine raindrops after being flushed into the air and sprayed with a rocking arm nozzle.

Model Implication

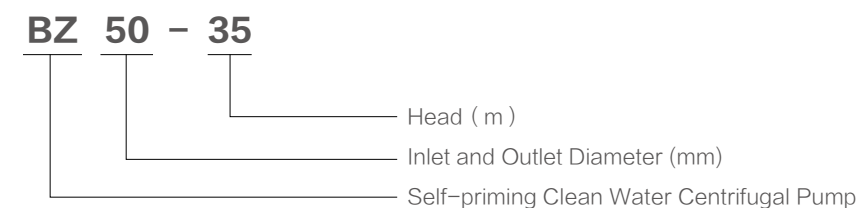



Structure:

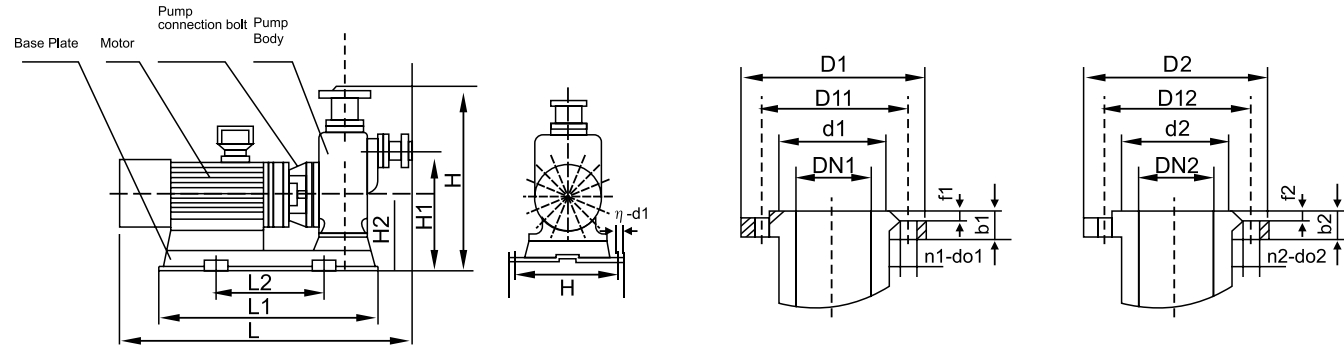

Technical Parameter

Model	Flow	Head	Power	Eff.	Speed	Suction	Appearance size							Installation DIM						Shock absorber specification	Suction Flange Size						Outlet Flange Size					
	m ³ /h	m	kW	HP	%	r/min	m	L	H	B	L1	L2	H1	H2	B1	n-d1	Dn1	D1	D11		d1	b1	f1	n1-do1	Dn2	D2	D12	d2	b2	F2	n2-do2	
BZ40-20	10	20	1.5	2	58	2900	6	520	425	300	390	220	275	170	250	4-φ16	JGD1	40	130	100	80	14	2	4-φ14	40	130	100	80	14	2	4-φ14	
BZ50-25	10	25	2.2	3	60	2900	6	590	480	300	440	275	300	185	255	4-φ16	JGD1	50	140	110	90	14	2	4-φ14	50	140	110	90	14	2	4-φ14	
BZ65-15	25	15	2.2	3	60	2900	6	590	480	300	440	275	300	185	255	4-φ16	JGD1	65	155	130	110	14	2	4-φ14	65	155	130	110	14	2	4-φ14	
BZ50-32	10	32	3	4	52	2900	7	650	480	350	470	255	200	185	305	4-φ16	JGD2	50	140	110	90	14	2	4-φ14	50	140	110	90	14	2	4-φ14	
BZ65-20	25	20	3	4	52	2900	6	650	480	350	470	255	200	185	305	4-φ16	JGD2	65	155	130	110	14	2	4-φ14	65	155	130	110	14	2	4-φ14	
BZ50-35	14	35	4	5.5	52	2900	7	670	500	370	505	280	340	200	325	4-φ16	JGD2	50	140	110	90	14	2	4-φ14	50	140	110	90	14	2	4-φ14	
BZ65-30	25	30	4	5.5	60	2900	6	670	500	370	505	280	340	200	325	4-φ16	JGD2	65	155	130	110	14	2	8-φ14	65	155	130	110	14	2	4-φ14	
BZ50-32II	21	32	4	5.5	60	2900	6	650	500	370	470	255	300	185	300	4-φ16	JGD2	50	140	110	90	14	2	8-φ18	50	140	110	90	14	2	4-φ14	
BZ50-45	15	45	5.5	7.5	51	2900	6	700	550	380	515	295	370	204	340	4-φ16	JGD2	50	140	110	90	14	2	8-φ18	50	140	110	90	14	2	4-φ14	
BZ50-50	20	50	5.5	7.5	60	2900	6	700	550	420	565	340	370	204	340	4-φ16	JGD2	50	140	110	90	14	2	8-φ18	50	140	110	90	14	2	4-φ14	
BZ65-40	25	40	5.5	7.5	60	2900	6	715	510	380	515	340	350	204	340	4-φ16	JGD2	65	155	130	110	14	2	8-φ18	65	155	130	110	14	2	8-φ14	
BZ80-13	30	13	2.2	3	76	2900	6	580	510	310	440	275	300	185	255	4-φ18	JGD2	80	185	150	125	18	2	8-φ18	80	185	150	125	18	2	8-φ18	
BZ80-30	50	30	7.5	10	76	2900	6	750	590	420	565	340	370	204	340	4-φ18	JGD3	80	185	150	125	18	2	8-φ18	80	185	150	125	18	2	8-φ18	
BZ80-40	48	40	11	15	76	2900	6	880	590	460	650	430	410	235	430	4-φ18	JGD3	80	185	150	125	18	2	8-φ18	80	185	150	125	18	2	8-φ18	
BZ80-50	31	50	11	15	56	2900	6	880	590	460	650	430	470	235	430	4-φ18	JGD3	80	185	150	125	18	2	8-φ18	80	185	150	125	18	2	8-φ18	
BZ80-65	50	65	15	20	62	2900	6	880	620	460	670	430	395	245	430	4-φ18	JGD4	80	185	150	125	18	2	8-φ18	80	185	150	125	18	2	8-φ18	
BZ100-20	100	20	7.5	10	75	2900	5	770	600	420	565	340	370	204	340	4-φ18	JGD3	100	210	180	150	18	2	8-φ18	100	210	180	150	18	2	8-φ18	
BZ100-45	100	45	15	20	68	2900	5	880	620	460	670	430	395	245	430	4-φ18	JGD4	100	210	180	150	18	2	8-φ18	100	210	180	150	18	2	8-φ18	

YEDJ

Fire Fighting System



Description

- Fire pumps are designed for whole operational life,the maximum reliability is always the first priority
- The components affixed onto a steel framing structure
- Each controller has its own individual pressure sensing line
- The suction line should never include a strainer
- Check valve and butterfly valve in the discharge line
- NFPA 20 not allows suction from negative level for end suction and split case pumps

Principle

When pressure drops below the set value, jockey starts running with the signal from the pressure switch and continues running for 10 minutes till the system pressure reaches the set value. If the pressure continues drop, first the main pump starts to run. If the system pressure can't supply and pressure continues drop,the standby pump starts to run.

Model Implication

YEDJ 500 / 8 - 50 - 58 - 5.5

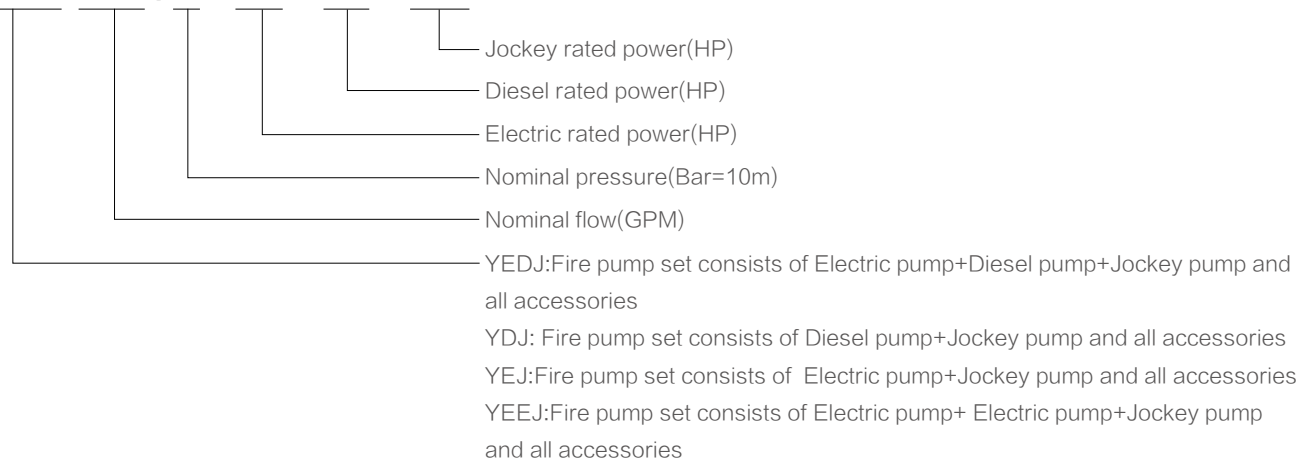

Technical Parameter

Q	H	GPM	Bar	Size	Length	Electric		Diesel	Pressure stabilizing pump	Pressure tank
						Image	Model			
50				YEDJ500/6-7.5-7.5	90CM	YST32-250/55	YSM32-250/55	YSD32-250/55 17.5HP (2V88A)	/	12L 10BAR+G3/4(Directly)
80				YEDJ800/6-10-10-2	145CM	YST40-200/75	YSM40-200/75	YSD40-200/75 17.5HP (2V88A)	CDL4-8-1.52HP	50L 10BAR+G1
150				YEDJ1500/6-20-27-2	145CM	YST50-200/150	YSM50-200/150	YSD50-200/150 32HP (385)	CDL4-8-1.52HP	
200				YEDJ200/6-20-27-3	145CM	YST50-250/150	YSM50-250/150	YSD50-250/150 32HP (385)	CDL8-6-2.23HP	
350			6	YEDJ350/6-30-32-3	145CM	YST65-250/220	YSM65-250/220	YSD65-250/220 49HP (485)	CDL8-6-2.23HP	
400				YEDJ400/6-40-49-5.5	160CM	YST80-200/300	YSM80-200/300	YSD80-200/300 61HP (490)	CDL12-6-4.55HP	
500				YEDJ500/6-50-61-7.5	160CM	YST100-200/370	YSM100-200/370	YSD100-200/370 73HP(498)	CDL16-5-5.57.5HP	100L 10BAR+G1
1200				YEDJ1200/6-100-102-15	160CM	YST125-200/750	YSM125-200/750	YSD125-200/750	CDL32-5-11 15HP	
1500				YEDJ1500/6-100-102-15	160CM	YST125-250/750	YSM125-250/750	YSD125-250/750	CDL32-5-11 15HP	
50				YEDJ500/7-10-10	90CM	YST32-250/75	YSM32-250/75	YSD32-250/75 17.5HP (2V88A)	/	12L 10BAR+G3/4(Directly)
80				YEDJ800/7-15-27-2	145CM	YST40-250/110	YSM40-250/110	YSD40-250/110 17.5HP (2V88A)	CDL4-8-1.52HP	50L 10BAR+G1
200				YEDJ200/7-25-27-4	145CM	YST50-250/185	YSM50-250/185	YSD50-250/185 38HP(480)	CDL8-8-3 4HP	100L 10BAR+G1
500			7	YEDJ500/7-40-49-4	145CM	YST65-250/300	YSM65-250/300	YSD65-250/300 61HP (490)	CDL8-8-3 4HP	
400				YEDJ400/7-50-61-7.5	160CM	YST80-200/370	YSM80-200/370	YSD80-200/370 73HP(498)	CDL12-7-5.57.5HP	
1000				YEDJ1000/7-75-85-10	160CM	YST100-250/550	YSM100-250/550	YSD100-250/550 113HP(4108Z)	CDL20-6-7.5 10HP	
1500				YEDJ1500/7-120-120-15	160CM	YST125-250/900	YSM125-250/900	YSD125-250/900	CDL32-5-11 15HP	
80				YEDJ800/8-15-27-1.5	145CM	YST32-250/110	YSM32-250/110	YSD32-250/110 20HP (2V88B)	CDL2-11-1.1 1.5HP	50L 10BAR+G1
250				YEDJ250/8-30-32-3	145CM	YST50-250/220	YSM50-250/220	YSD50-250/220 49HP (485)	CDL4-10-2.2 3HP	
600			8	YEDJ600/8-60-61-7.5	160CM	YST80-250/450	YSM80-250/450	YSD80-250/450 91HP(4105)	CDL12-8-5.5 7.5HP	100L 10BAR+G1
1000				YEDJ1000/8-100-102-10	160CM	YST100-250/750	YSM100-250/750	YSD100-250/750	CDL20-7-7.5 10HP	
80				YEDJ800/9-25-27-3	145CM	YST40-250/185	YSM40-250/185	YSD40-250/185 38HP(480)	CDL4-12-2.2 3HP	50L 16BAR+DN40(Flange)
250				YEDJ250/9-50-61-5.5	145CM	YST65-250/370	YSM65-250/370	YSD65-250/370 73HP(498)	CDL8-10-4 5.5HP	
500			9	YEDJ500/9-60-61-7.5	145CM	YST65-315/450	YSM65-315/450	YSD65-315/450 91HP(4105)	CDL12-9-5.5 7.5HP	
600				YEDJ600/9-75-85-7.5	160CM	YST80-250/550	YSM80-250/550	YSD80-250/550 113HP(4108Z)	CDL12-9-5.5 7.5HP	100L 16BAR+DN40(Flange)
1000				YEDJ1000/9-120-120-15	160CM	YST100-250/900	YSM100-250/900	YSD100-250/900	CDL20-8-11 15HP	
500			11	YEDJ500/11-75-85-10	145CM	YST65-315/550	YSM65-315/550	YSD65-315/550 113HP(4108Z)	CDL12-10-7.5 10HP	50L 16BAR+DN40(Flange)
600			12	YEDJ600/12-100-102-10	160CM	YST80-315/750	YSM80-315/750	YSD80-315/750	CDL12-10-7.5 10HP	100L 16BAR+DN40(Flange)
500			13	YEDJ500/13-100-102-10	145CM	YST65-315/750	YSM65-315/750	YSD65-315/750	CDL12-12-7.5 10HP	50L 16BAR+DN40(Flange)
600			14	YEDJ600/14-120-120-15	160CM	YST80-315/900	YSM80-315/900	YSD80-315/900	CDL12-14-11 15HP	100L 16BAR+DN40(Flange)

Controller

Description







- Equipped with Smartgen display screen, integrates digitalization, intellectualization and network technologies for precise data measurement, alarm protection, remote control, measuring and communication
- DOL or Star Delta starter
- All controllers completely assembled, wired, and tested
- Self-acting to start, run, and protect the driver
- Automatic or manual operation options



Application

Fire pump controllers are used to monitor and to start and stop fire pumps.

Other Accessories

 Suction and discharge line	 Brass gate valve Brass check valve	 Pressure gauge	 Pressure switch
 Os&y valve	 Gate valve	 Check valve	 Flexible joint
 Battery	 Pressure tank	 Coupling	 Fuel tank
 Muffler	 Air filter	 Radiator	 Solenoid

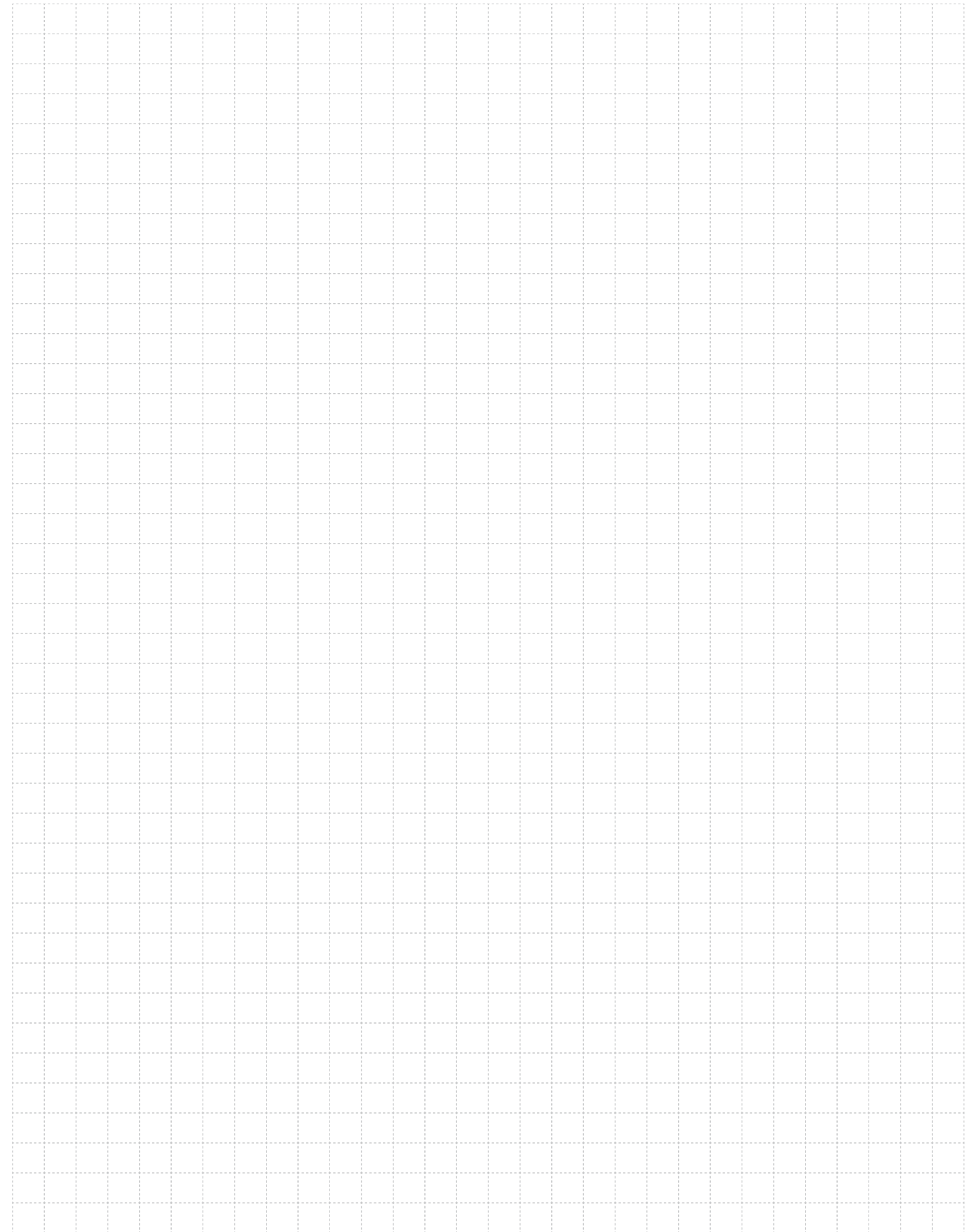

Hot Sale Ductile Cast Iron Pipe k9 c25 c30 c40 Specification Cut Ductile Iron Pipe Cast Iron Steel

The ductile iron materia features similar mechanical properties with carbon steel such as highmechanical strength,good ductility,and the same anti-corrosion performance as cast iron. Therefore,it has gradually become the world's most safe and reliable pipes and fittings in the field of watersupply and drainage.

Ductile Iron Pipe

Product Parameters

Standard	Product	Nominal Diameter DN(mm)	Tensile Strength N/mm2	Yield Strength N/mm2	Elongation%	Hardness HB
ISO2531/EN545/GB13295	Ductile Iron Pipes	DN80-1000mm	≥420	≥300	10	≤230
		DN1100-2600mm		≥300	7	
	Ductile Iron Fittings	DN80-2600mm	≥420	≥300	5	≤250

Standard Of Hydrostatic Testing Pressure (Class K9)

Standard	Product	Nominal Diameter DN(mm)	Testing Pressure(Bar)	Time(second)
ISO2531/EN545/GB13295	Ductile Iron Pipes	DN80-300mm	50	≥10
		DN350-600mm	40	
		DN700-1000mm	32	
		DN1100-2000mm	25	
		DN2200-2600mm	18	
	Ductile Iron Fittings	DN80-300mm	25	≥10
DN350-600mm		16		
DN700-2600mm		10		



鑫兴铸业（晋城）有限公司
XINXING CASTING INDUSTRY (JINCHENG) CO.,LTD

CERTIFICATE OF DISTRIBUTION

this certificate is proudly presented to

MIROLEX B.V

GENERAAL LEMANSTRAAT 55/2 2019 ANTWERPEN/ BELGIUM
AS OUR AUTHORIZED DISTRIBUTOR TO QUOTE 'DUCTILE PIPE' RANGE OF PRODUCTS.
THEY ARE ALSO AUTHORIZED TO PARTICIPATE IN TENDER AND NEGOTIATE ON OUR
BEHALF FOR THE TERRITORY MENTIONED ABOVE. THEY WILL ALSO EXTEND ALL AFTER
SALES SUPPORT FOR OUR PRODUCTS IN REPUBLIC OF IRAQ.



MANAGER



Tel: +86-13033505868
E-mail: Zora@sxxinxiangsteel.com
WhatsApp: +8613033505868
Address: 203, 2/F, Daqian Office Building, No.197 Fengtai East Street, Jincheng District, Shanxi Province, China

www.sxxinxiangsteel.com



BUREAU
VERITAS

FACTORY APPROVAL CERTIFICATE

Certificate No.: BVQ/CB/2023/0007-02

Applicant Name: Xinxing Casting Industry (Jincheng) Co., LTD
Applicant Address: 203, 2nd Floor, Daqian Office Building, 197 Fengtai East Street, Jincheng City, Shanxi Province
Manufacturer Name: Xinxing Casting Industry (Jincheng) Co., LTD
Manufacturer Address: 203, 2nd Floor, Daqian Office Building, 197 Fengtai East Street, Jincheng City, Shanxi Province
Factory Name: Xinxing Casting Industry (Jincheng) Co., LTD
Factory Address: 203, 2nd Floor, Daqian Office Building, 197 Fengtai East Street, Jincheng City, Shanxi Province

Product Name: Ductile iron pipes
Nominal size and Joint type of product certified: DN 100-DN 1000, Flexible joints (TYT)
Certification Standards: EN 545:2010(E), ISO 2531:2009(E)
Certificate Scheme: 5

- After examination of the following documents:
- Quality System Certificate n° (ISO9001:2015): 00222Q20429R3M
(Valid Date: 2022-01-17 to 2025-02-25)
 - Factory Audit Report n° FR- IPC/NR/IPCA-23/040

It is certified that the above factory meets the applicable certification standard and rules (BVQS-PV10-01) with Certification surveillance in Annex I.

This certificate is valid from : **May. 25, 2023**
For a period of three years, ending : **May. 24, 2026**

This approval is only valid provided that each semi-annual audit is done and found satisfactory, and when no significant changes are made to the audited facility, its production rate and its quality system.

Made at: Shanghai

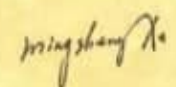

Name & signature: 
Certificate: Mingsheng Xu

Date: May. 25, 2023

Product/Technical Manager

